

foodservice • sanitary maintenance • healthcare • table coverings

# foodserviceproducts



C  
A  
R  
L  
I  
S  
L  
E  
F  
O  
O  
D  
S  
E  
R  
V  
I  
C  
E  
P  
R  
O  
D  
U  
C  
T  
S  
2  
0  
1  
2

Visit our online catalog at [carlislefsp.com](http://carlislefsp.com)



[www.carlislefsp.com](http://www.carlislefsp.com)



191144, Санкт-Петербург, ул.Моисеенко, д. 5

Телефон: (812) 335-21-16, (812) 335-21-17

Почта: [mail@mirposudy.ru](mailto:mail@mirposudy.ru)

[www.mirposudy.ru](http://www.mirposudy.ru)



2012



Carlisle is your trusted resource for all of your foodservice supplies. Throughout this catalog you will find information on Carlisle products ranging from front-of-house to back-of-house — proving for all your foodservice items — one company is all you need.

Included inside this catalog:

- Technical Specifications for many Carlisle products – including dimensions, capacities, material content, electrical information, and more
- Care and Use Instructions
- Details on our many money-saving Warranties
- Custom Decorating – specifications, product charts, and costs
- Replacement Parts
- Food Bar Pan Layouts (shown with the food pans in the Storage & Handling Section)
- OptiClean™ Glass Rack Sizing Guide –including convenient sizing chart to help select the correct glass rack size
- 21 Key Brush Guide – provides a basic guideline for stocking your kitchen with the brushes you need



Our on-line Solution Center includes helpful tips and money saving ideas for you to use. Plus, you can find out about all of our newest items and product improvements designed to make your business run smoother. You can see how to qualify for rebates and other special offers direct from Carlisle that can save you hundreds of dollars on the professional quality foodservice and cleaning tools you use every day. If you've got questions, or if you need help, [www.carlislefsp.com](http://www.carlislefsp.com) has your answers.

Look for these helpful symbols located throughout our catalog



**Cash 'N Carry Catalog Section.** Many products are available in a cash 'n carry pack. This symbol will direct you to where you can find these products.



Critical Control Point Products are designed to help with your HACCP Program.



NSF Listed products are designated with a **Δ** throughout this catalog.



Look for extended warranties on our most durable products.



The Top 21 Sparta® Brushes recommended for any foodservice operation.



Burgundy(61)

New improved layout include product charts in table format & simplified color keys.

Visit us online at [www.carlislefsp.com](http://www.carlislefsp.com)



# TABLE OF CONTENTS

■ Dinnerware	5-28	■ Foodservice Trays	121-132	■ Floor & Restroom Care	221-252
■ Drinkware	29-42	■ Catering Equipment	133-140	■ Transportation	253-260
■ Tabletop Accessories	43-56	■ Professional Cookware	141-152	■ Waste Management	261-272
■ Displayware	57-80	■ Kitchen Accessories	153-172	■ Cash & Carry	273-288
■ Buffet Service	81-90	■ Storage & Handling	173-188	■ Reference & Replacement Parts	289-306
■ Food Bars & Convenience	91-108	■ Warewashing	189-202	■ Index	307-320
■ Bar Supplies	109-120	■ Cleaning Tools	203-220		

PRODUCT	PAGE	PRODUCT	PAGE	PRODUCT	PAGE
21 Key Brushes . . . . .	204	Cateraide Slide 'N Seal Insulated . . . . .	138	Cake & Display Stands . . . . .	80
Acrylic Ice Buckets . . . . .	120	Cateraide XT Series Insulated . . . . .	138	Cans, Trash . . . . .	261-272
Acrylic Pebbled Bowls . . . . .	76	Beverage Urns . . . . .	82, 84	Carlisle Dollies . . . . .	262, 264
Adapter Bars . . . . .	85, 176	Bins, Ingredient . . . . .	188	Carts	
Adapter Plates . . . . .	176	Bistro Trays . . . . .	124	Bussing/Transport . . . . .	255
Adjustable Cup Dispensers . . . . .	106	Board & Brush Racks . . . . .	154, 155	Fold 'N Go Carts . . . . .	254
Adjustable Handle Trolley . . . . .	257	Booster Seats . . . . .	56	Janitorial Carts . . . . .	260
Allegro & Maestro Display Bowls . . . . .	79	Bottle Pourers . . . . .	116	Service Carts . . . . .	256
All Purpose Utility Scrub Brushes . . . . .	210	Bowls		Stainless Steel Carts . . . . .	256
Aluminum Displayware . . . . .	78	Coldmaster Coldbowl . . . . .	95	Utility Carts . . . . .	257
Aprons . . . . .	172	Display Bowls . . . . .	58-71, 74-79	Cateraide Dollies . . . . .	137
Atlas Multi-Purpose Brushes . . . . .	206	Melamine Bowls . . . . .	58-60, 62, 64-68	Cateraide Universal Dolly . . . . .	137
Bains Maries		Melamine Salad Bowls . . . . .	25	MY410 End Loader Dolly . . . . .	134
Plastic . . . . .	186	Pebbled Salad . . . . .	76	CaterCooler . . . . .	136
Stainless Steel . . . . .	176	Petal Mist Bowls . . . . .	24	Carafe, 2 Cup . . . . .	39
Bake Pan Lip Brush . . . . .	206	Salad Bowls . . . . .	74-76	Centurian Waste Containers . . . . .	266
Bakers, Deli . . . . .	69	Woodgrain Salad Bowls . . . . .	24	Chafer Accessories . . . . .	84, 85
Bakery Trays . . . . .	122	Braziers . . . . .	144, 146	Chafer Replacement Parts . . . . .	298
Bakeware . . . . .	150-152	Bread & Bun Basket . . . . .	56	Chafers . . . . .	82, 83
Baking Pans . . . . .	150, 151	Bread Pans . . . . .	150, 151	Charger Plates . . . . .	24
Balsam Displayware . . . . .	58	Bronco Waste Containers & Lids . . . . .	262, 288	Cheese Shaker/Sugar Pourer . . . . .	48
Balti Dishes . . . . .	78	Brooms		Chopsticks . . . . .	45
Bar Accessories . . . . .	118	Angle Brooms . . . . .	222, 223	Clutter Busters . . . . .	85
Bar Caddy . . . . .	114	Natural Corn & Blend Brooms . . . . .	225	Cocktail Shakers . . . . .	118
Bar Mat & Service Mat . . . . .	115	Recycled Broom . . . . .	223	Coffee Mugs . . . . .	38
Bar & Shelf Liner . . . . .	115	Synthetic Corn Broom . . . . .	225	Coffee Service . . . . .	55
Bar Trays . . . . .	126	Brushes . . . . .	154, 155, 160-162, 207-212, 214-215, 220	Cheese Shaker/Sugar Pourer . . . . .	48
Barware/Drinkware		Dual Surface Brushes . . . . .	228	Creamer/Pitchers . . . . .	48
Alibi Barware . . . . .	30	Swivel Floor Brushes . . . . .	228	Drip Trays, NeWave . . . . .	90
Alibi Stemware . . . . .	30	Tile & Grout Brushes . . . . .	229	Sugar Caddies . . . . .	48
Liberty Drinkware . . . . .	31	Brush Racks . . . . .	236, 237	Colanders . . . . .	168
Baskets		Bud Vases . . . . .	51	Coldmaster Products	
Basket Server . . . . .	51	Buffet Clam Shells . . . . .	75	CaterCooler . . . . .	136
Bread & Bun Basket . . . . .	51	Buffet, Servingware . . . . .	86	Coldmaster Coldbowl . . . . .	95
Munchie Baskets . . . . .	50	Buffet Tongs . . . . .	86, 87	Coldmaster Coldcrock & Accessories . . . . .	94
WeaveWear Baskets & Platter . . . . .	50	Bun Pans & Sheet Pans . . . . .	151	Coldmaster Coldpans . . . . .	93
Wicker Basket . . . . .	51	Burger Cover . . . . .	148	Coldmaster Condiment Bar Organizers . . . . .	95
Woven Baskets . . . . .	50	Bus Boxes & Lids . . . . .	202	Coldmaster Dispenser . . . . .	95
Basting Brushes . . . . .	160-162, 284	Bussing Carts . . . . .	255	Coldmaster Ice Cream Server & Lid . . . . .	94
Batter Pan . . . . .	166	Butcher Block Brushes . . . . .	217	Coldmaster Standard Food Pans & Lids . . . . .	92
Bell Bowls . . . . .	74	Butter Dish . . . . .	49	Coldmaster Condiment Bar & Organizer . . . . .	95
Beverage Dispensers . . . . .	108	Caddies, Condiment & Bar . . . . .	104-107	Color-Coded Glass Racks . . . . .	192-194
Beverage Servers (continued above)		Café Trays . . . . .	125	Compartment Trays (continued on next page)	
Cateraide LD Series Insulated . . . . .	139	Cake Covers & Tray . . . . .	80	4-Compartment Trays . . . . .	132

PRODUCT	PAGE	PRODUCT	PAGE	PRODUCT	PAGE
Compartment Trays (continued)		Display Covers . . . . .	80	Food Boxes, Containers	
5-Compartment Trays . . . . .	132	Display Cubes . . . . .	89	StorPlus Food Storage Boxes & Lids . .	182, 183
6-Compartment Trays . . . . .	130	Display Stands . . . . .	90	StorPlus Round Containers . . . . .	186
Compost Containers . . . . .	270	Display Trays . . . . .	89	StorPlus Square Food Storage Containers . .	184
Condiment Bars & Accessories . . . . .	104-107, 114	Displayware		Food Pans	
Condiment Caddies & Pumps . . . . .	105, 107, 114	Aluminum Displayware . . . . .	78	DuraPan Food Pan Accessories . . . . .	174
Condiment Organizers . . . . .	104	Balsam . . . . .	58	DuraPan Food Pans . . . . .	174-176
Condiment Pump . . . . .	105	Decorated Palette Designer Displayware . . . .	64	High Heat Pans . . . . .	181
Containers		Designer Displayware . . . . .	68	Polycarbonate Pans . . . . .	180
Bains Mariés . . . . .	176, 186	Double-Wall Stainless Steel Displayware . . . .	77	Smart Lids . . . . .	179
Food Boxes . . . . .	182, 183	Epicure Displayware . . . . .	66	Top Notch Food Pans . . . . .	174-178
Food Pans . . . . .	174, 175, 178-181	Modular Displayware . . . . .	72	Universal Food Pan Lids . . . . .	178
Rounds . . . . .	186	Octagonal Crocks & Platter . . . . .	71	Food Preparation Brushes . . . . .	162
Squares . . . . .	184, 185	Palette Designer Displayware . . . . .	62	French Whips . . . . .	170
Corinthian Crocks & Platter . . . . .	69	Rave Displayware . . . . .	60	Fry Pans . . . . .	142-145
Cookware . . . . .	144-148	Rimmed Melamine Displayware . . . . .	66	Fryer Baskets . . . . .	148
Covers . . . . .	144, 148	Terra Displayware . . . . .	61	Glass Rack Sizing Guide . . . . .	195
Crocks		Tulip Deli Crocks & Platter . . . . .	70	Glass Racks	
Classic Crock Condiment Station . . . . .	97	Disposable Lids . . . . .	42	9-Compartment . . . . .	194
Classic Crocks . . . . .	96	Double Boiler . . . . .	148	16-Compartment . . . . .	192
Gourmet Crocks . . . . .	96	Drain Grates . . . . .	176	20-Compartment . . . . .	191
Poly-Tuf Crocks . . . . .	96	Dredges/Powder Cans . . . . .	169	25-Compartment . . . . .	192
Supreme Crocks . . . . .	96	Drinkware . . . . .	30-42	30-Compartment . . . . .	191
Cup Dispensers . . . . .	106	Drip Trays . . . . .	90	36-Compartment . . . . .	192
Cutting Boards & Accessories . . . . .	154, 155	Dust Mops . . . . .	238	49-Compartment . . . . .	194
Deli Crocks/Platters/Pans . . . . .	60-73	Dust Pans & Lobby Brushes . . . . .	224	Glass Rimmers . . . . .	116
Deliware Rectangular Crocks . . . . .	73	Dusters . . . . .	238	Gravy Boats . . . . .	48
Dessert Dish . . . . .	23	Electric Kettle . . . . .	102	Grill Bricks, Screens . . . . .	216
Dinnerware		End Loaders		Griptite Trays . . . . .	126
Commercial Dinnerware . . . . .	22	Cateraide Insulated End Loader . . . . .	136	Hand & Nail Brushes . . . . .	209
Dallas Ware Dinnerware . . . . .	14	Cateraide Slide 'N Seal End Loaders . . . . .	135	Handles . . . . .	234-236
Dayton Dinnerware . . . . .	12	MY400 End Loader . . . . .	134	Handle Guide . . . . .	251, 252
Durus Designer Patterns . . . . .	8	Fire Resistant Wastebaskets . . . . .	269	Heat Lamps . . . . .	156
Durus Dinnerware . . . . .	6	Flared Square Bowls . . . . .	59	Ice Buckets & Caddies . . . . .	120, 140
Epicure Dinnerware . . . . .	19	Floor Maintenance		Ice Caddies, Cateraide . . . . .	140
Kingline Dinnerware . . . . .	16	Caution Barriers & Cones . . . . .	248	Ice Cream Server, Coldmaster . . . . .	94
Sierras Dinnerware . . . . .	10	Floor Drain Brush & Drain Opener . . . . .	249	Ice Only Container . . . . .	159
Small Plates . . . . .	23	Boot 'N Shoe Brush . . . . .	250	Ice Scoops . . . . .	120, 158
Square Dinnerware . . . . .	18	Wet Floor Signs . . . . .	248	Ice Sculptures . . . . .	88
Terra Dinnerware . . . . .	18	Floor Rack System . . . . .	188	Ice Totes, Containers . . . . .	159
Dish Dollies, Optimizer . . . . .	258	Floor Squeegees		Icing Grates . . . . .	152
Dish Racks		Double Foam Squeegees . . . . .	230, 231	Illuminated Trays . . . . .	88
All-Purpose Plate & Tray Rack . . . . .	198	Rubber Squeegees . . . . .	232	Insets, Stainless . . . . .	177
Combination/Flatware Rack . . . . .	198	VersaClean Brush & Squeegees . . . . .	233	Insulated Food Pan Carriers . . . . .	134-136
Cup Racks . . . . .	198	Floor Sweeps		J-Jars . . . . .	49, 276
Peg Racks . . . . .	198	All Purpose Omni Sweep . . . . .	226	Janitorial Carts & Accessories . . . . .	260
Open/Bowl Racks . . . . .	198	Fine Floor Sweeps . . . . .	226	Ladles . . . . .	86, 98, 165
Dishers . . . . .	164	Heavy Floor Sweeps . . . . .	227	Leaf Plates . . . . .	24
Dishes, Roll-Top . . . . .	55	Medium Floor Sweeps . . . . .	226	Lid & Condiment Organizer . . . . .	107
Dispensers		Multi-Surface Floor Sweeper . . . . .	224	Liquor Pourers . . . . .	116
Counter Top Lid & Straw Dispenser . . . . .	107	Fold 'N Go Carts . . . . .	254	Low Temperature Equipment Brushes . . . . .	212
Cup Dispensers . . . . .	106	Food Bars . . . . .	100-103	Market Pans & Trays . . . . .	124
Display Cases, Pastry . . . . .	103			Marmites . . . . .	84



<b>PRODUCT</b>	<b>PAGE</b>	<b>PRODUCT</b>	<b>PAGE</b>	<b>PRODUCT</b>	<b>PAGE</b>
Maximizer Food Bar . . . . .	100	Pasta Forks . . . . .	99	Restroom Maintenance	
Measure Misers . . . . .	166	Pastry Brushes . . . . .	160-162	Bowl Brushes . . . . .	250
Measurers		Pastry Display Cases . . . . .	103	Ergonomic Force Cup . . . . .	250
Commercial Measurers . . . . .	164	Pastry Tray Covers . . . . .	132	Rimmed Melamine Displayware . . . . .	66
Measuring Cups . . . . .	164	Pebbled Punch Bowls . . . . .	90	Risers . . . . .	80
Measuring Spoons . . . . .	164	Peeler . . . . .	172, 284	Roasters . . . . .	150
Portioning Cups . . . . .	164	Petal Mist . . . . .	24, 74, 274	Roll 'N Grip Plus . . . . .	286
Meat Tenderizer . . . . .	172	Petal Mist Displayware . . . . .	74	Roll-Away Container . . . . .	265
Melamine Dinnerware . . . . .	8-23	Pie Pans . . . . .	152	Room Service Trays . . . . .	128
Microfiber Cleaning Solutions . . . . .	218, 238	Pitchers		Rotary Brushes . . . . .	229
Microwave Ware . . . . .	28	Crystalite Polycarbonate Pitchers . . . . .	41	Round Beverage Dispensers . . . . .	108
MirAcryl Mirrored Display		Élan Polycarbonate Pitcher . . . . .	41	Round Heavy-Weight Tray . . . . .	129
Display Cubes . . . . .	89	Polycarbonate Pitchers . . . . .	40	Round Polycarbonate Pebbled Bowls . . . . .	76
Display Trays . . . . .	89	Stainless Steel Pitchers . . . . .	41	Round Trays . . . . .	128
Mixing Bowls . . . . .	166, 167	VersaPour Polycarbonate Pitchers . . . . .	40	Salad Bars . . . . .	100-102
Modular Displayware . . . . .	72	Plaque-A-Rack System . . . . .	196, 197	Salad Bowls . . . . .	74-76
Molcajete Ramekins . . . . .	46	Plate Covers		Salad Spoon . . . . .	99
Money Maid Combo Packs . . . . .	117	Custom Plate Covers . . . . .	26	Salsa Dishes & Bowls . . . . .	46
Mop Buckets . . . . .	247	Polycarbonate Plate Covers . . . . .	26	Sauce Cups, Cash 'N Carry . . . . .	276
Mops, Mop Handles & Accessories		Polyglass Plate Covers . . . . .	26	Sauce Cups	
Cut-End Mops . . . . .	244	Plate Stands . . . . .	68	Sea Shell . . . . .	46
Looped-End Mops . . . . .	241-243	Platters . . . . .	53	Soufflé . . . . .	46
Mop Bucket/Wringer Combos . . . . .	247	Polycarbonate Trays . . . . .	124	Stainless Steel . . . . .	46
Mop Handles . . . . .	246	Polypropylene Block Kitchen Brushes . . . . .	210	Sauce Pans . . . . .	144, 146
Screw Top Mops . . . . .	244	Poly-Tuf Crocks . . . . .	96	Sauce Pots . . . . .	144
Sponge Mops . . . . .	245	Portion Control Liquor Pourers . . . . .	116	Sauté Pans . . . . .	144, 146
Muffin Pans . . . . .	150, 152	Pour Free . . . . .	116	Save-All Compartmented Bus Boxes . . . . .	202
Mugs, Coffee . . . . .	38	Poura-Clean Liquor Pourer Cleaning System . . . . .	116	Scalloped DeliWare & Inset . . . . .	67
Multi-Surface Floor Sweeper . . . . .	286	PourPlus . . . . .	113	Scalloped Platters . . . . .	60
Number Stands . . . . .	55	Pump Kit . . . . .	278	Scoop Bowl . . . . .	69
Octagon Bowls . . . . .	70	Punch/Serving Bowls . . . . .	90	Scoops . . . . .	120, 158
Octagonal Crocks, Platter . . . . .	71	Rack Cover . . . . .	201	Scrapers . . . . .	170
Octagonal Trays . . . . .	128	Rack Dollies . . . . .	200	Scratch Brushes . . . . .	216
Office Wastebaskets . . . . .	269	Ramekins . . . . .	276	Scrubs, Sponges . . . . .	207
One Gallon Container . . . . .	163	Ramekins		Server, Tortilla . . . . .	157
OptiClean Dish Racks . . . . .	198	Carlisle . . . . .	46	Servers, Tiered . . . . .	90
Optimizer Adjustable Dish Dollies . . . . .	258	Japanese Style . . . . .	45	Service Cart . . . . .	256
Optimizer Adjustable Dish Dolly Guide . . . . .	259	Melamine . . . . .	44-46	Serving Spoons, Buffet Spoons & Pasta Forks . . . . .	99
Orchid Deli Bowls . . . . .	70	Molcajete . . . . .	46	Serving Trays	
Order Racks . . . . .	158	Oval . . . . .	44	Melamine . . . . .	54
Order Wheels . . . . .	158	SAN . . . . .	47	Plastic . . . . .	54
Oval Trays . . . . .	128	Scalloped . . . . .	45	Serving Trays . . . . .	128, 129
Oven/Broiler Brushes, Scrapers . . . . .	214	Square . . . . .	44	Servingware	
Packet Racks . . . . .	104	Stainless Steel . . . . .	46	Aria Servingware . . . . .	86
Paddle Scrapers . . . . .	171	Straight Sided . . . . .	44	Crescendo Servingware . . . . .	86
Pails, Cleaning, Disinfecting . . . . .	218	Rave Displayware . . . . .	60	Venico Servingware . . . . .	86
Palette Designer Displayware . . . . .	62	Rectangular Deli Crocks, Platter . . . . .	73	Shaker/Dredge . . . . .	169
Palette Displayware Covers . . . . .	63	Rectangular Microfiber Bucket . . . . .	238	Shakers, Cocktail . . . . .	118
Pan Carriers . . . . .	136	Rectangular Trays . . . . .	122, 128	Sheet Pan Carriers . . . . .	136
Pans		Recycle Containers & Lids . . . . .	270, 271	Sheet Pans . . . . .	151
Baking . . . . .	150, 151	Recycle Lable Kit . . . . .	271	Shelf Liner . . . . .	115
Pullman & Bread . . . . .	151	Red Wine Holder . . . . .	118	Shelves, Drain . . . . .	175, 176, 180, 181
Springform . . . . .	152	Replacement Parts . . . . .	298-303	Shovels . . . . .	172
Pasta Cookers, Sectional . . . . .	147				

PRODUCT	PAGE	PRODUCT	PAGE	PRODUCT	PAGE
Six Star Food Bars	101	Steak Weight	172	TrimLine Waste Containers	267
Skimmers, Wire Mesh	168	Stemware	30, 31	TrimLine Rectangular Beverage Dispensers	108
Sneeze Guards	102	Step Risers	80	Tulip Deli Crocks & Platter	70
Soup & Chili Servers	139	Step-On Containers	268	Tulip Dishes	23, 274
Soup Server, Electric	277	Steri- & Suds-Pails	218	Tumblers, Cash 'N Carry	275
Soup Service	28	Stock Pots	144, 146	Tumblers	
Spaghetti Strainers	168	Store 'N Pour	112, 278	Bistro SAN Tumblers	34
Sparta Bottle & Jar Brushes	208	Store 'N Pour Bar Service Pack	112	Coca-Cola Stackable Tumblers	32
Sparta Coffee Service Brushes	212	Store 'N Pour Complete Units & Backups	113	Crystalon PC Tumblers In RimGlow Colors	36
Sparta Glass Washing Brushes	208	Store 'N Pour Complete Units & Backups	113	Crystalon SAN Stack-All Tumblers	35
Sparta Spectrum Series	205	Store 'N Pour Condiment System	114	Lafayette Polycarbonate Tumblers	37
Spatulas	170, 171	Store 'N Pour Versatility	112	Lexington Polycarbonate Mug	38
Spatulas & Scrapers	284	Straw Dispenser	107	Lorraine SAN Tumblers	34
Specialty Racks		Sugar Caddies	48, 276	Louis SAN Tumblers	34
Bakery Tray & Sheet Pan Rack	199	Sugar Pourer/Cheese Shaker	48	Pebble Optic SAN Tumblers	33
Food Pan/Insulated Meal Delivery Tray Rack	199	Suds-Pails	218	Polycarbonate Stackable Tumblers	36
Plate Cover Rack	199	Supreme Crocks	96	Stackable SAN Tumblers	32
Speed-Rak Bottle Holders	114	Sweep Complete	288	Swirl Polycarbonate Tumblers	36
Speed Spouts	113	Swivel Scrub Floor Brushes	286	Turner, High Heat	170
Sponges, Scour Pads	207, 218	Syrup Pitchers	276	Urns, Beverage	82, 84
Spoons	86	Terra Displayware	61	Universal Roll-Top Cover	84
Spoons, High Heat	170	Ticket Wheels	158	Universal Wire Lid Holder	84
Spouts	113	Tilt Trucks	272	Utility Brush	162
Springform Pans	152	Timer	172	Utility Carts	256, 257
Spouts, Pumps, Valves	213	Tip Trays	117, 278	Vases, Bud	49
Square Beverage Dispenser	108	Tongs	86, 87, 98, 168	Versata Select	144
Square Bronco Waste Containers, Lids	264	Tool Caddy	260	Warewashing Accessories	200-202
Square Display Dishes	78	Toothbrush Style Utility Brushes	216	Washing Baskets, Flatware	200
Squeegees	230-233	Toothpick Dispenser	107	Waste Containers	261-272
Stack Bowls	74	Top Loaders		Water Pan, Electric	85, 277
Stands, Number	127	Cateraide Insulated Top Loaders	136	Wet Floor Sign	248
Stands, Tray	55	Cateraide Slide 'N Seal Top Loaders	135	Whips, French	170
Stainless Steel Speed-Rak Bottle Holders	114	Tool Caddy Bag	263	Window Scrapers	219
Stainless Steel Trays	128, 129	Topping Rails	105	Wine Buckets & Stands	119
Stainless Steel Utility Carts	256	Tortilla Servers	52, 157	Wine Servers	118
Standard Platform Truck	257	Trapezoid Trays	122	Wine Servers & Coolers	118
Standard Pump Kit	104	Tray Carriers	136	Wire Mesh Skimmers	168
Standard Topping Rails	105	Tray Covers	132		
Standard Weight Aluminum Cookware	146	Tray Stands	127		
		Trays, Serving	54		





# DINNERWARE

Carlisle dinnerware sets the industry standard for functional beauty and lasting value. With pieces ranging from melamine to polycarbonate, we are able to meet all of your dinnerware needs by offering you both versatile and durable pieces.

<b>Product</b>	<b>Page</b>
Bowls	
Melamine Salad Bowls . . . . .	.25
Petal Mist Bowls . . . . .	.24
Woodgrain Salad Bowls . . . . .	.24
Charger Plates . . . . .	.24
Dinnerware	
Commercial Dinnerware . . . . .	.22
Dallas Ware Dinnerware . . . . .	.14
Dayton Dinnerware . . . . .	.12
Durus Designer Patterns . . . . .	.8
Durus Dinnerware . . . . .	.6
Epicure Dinnerware . . . . .	.19
Kingline Dinnerware . . . . .	.16
Sierrus Dinnerware . . . . .	.10
Small Plates . . . . .	.23
Square Dinnerware . . . . .	.18
Terra Dinnerware . . . . .	.18

<b>Product</b>	<b>Page</b>
Leaf Plates . . . . .	.24
Microwave-Ware . . . . .	.28
Petal Mist Plates & Bowls . . . . .	.24
Plate Covers	
Custom Plate Covers . . . . .	.26
Polycarbonate Plate Covers . . . . .	.26
Polyglass Plate Covers . . . . .	.26
Soup Service . . . . .	.28
Tulip Dishes . . . . .	.23

# MELAMINE DINNERWARE

## Durus® Dinnerware

Carlisle continues to offer interesting color and pattern options in the Durus Dinnerware line. Enticing Caribbean & Mediterranean colors & new contemporary patterns can combine to create an attractive table setting.

### Caribbean Colors



Coordinating Tumblers, Ramekins & Soup Bowls are also shown above. Additional information on coordinating pieces can be found in the Drinkware & Tabletop Accessories catalog sections.

- High quality, heavy-weight melamine dinnerware has the look and feel of china without the replacement cost
- Available in solid colors as well as classic and contemporary designer patterns
- Minimize your scratch and stain problems with our exclusive mirror-like glaze
- See a return on investment in less than 18 months in most operations after switching to Durus from china
- Reduced dinnerware drying time due to the advanced Durus foot design and slick water-sheeting glazed surface
- Save money with our Durus four-year warranty\* against breakage – the best guarantee in the industry
- Mix and match Durus side dishes with china plates for a beautiful tabletop that costs less to maintain
- Durus dinnerware can be decorated, see page 295 for details
- Safe for temperatures up to 212°F
- NSF Listed; dishwasher safe



\*See page 304 for complete warranty information

### Mediterranean Colors







Shown L to R: White(02), Bone(42), Sunset Orange(52), Honey Yellow(22), Meadow Green(09), Ocean Blue(14), Roma Red(58), Venetian Tan(77), Firenze Green(16), Napoli Plum(68), Sand(71), Black(03)

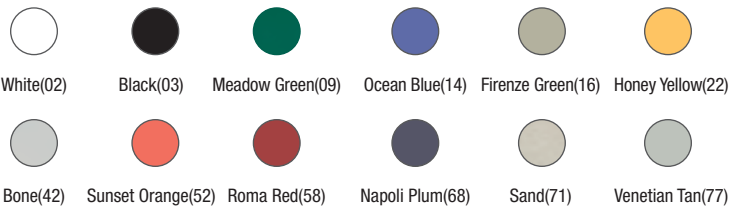

Prod No	Description	Color	Pack	Cs Wt/Cube
<b>Durus Narrow Rim Plates</b>				
43000 $\Delta$	10.5" 3-Compartment Plate	42	12 ea	12.15/0.46
43002 $\Delta$ <b>C</b>	10.5" Dinner Plate	02, 09, 14, 22, 42, 52	12 ea	11.30/0.41
43004 $\Delta$	9" Dinner Plate	02, 09, 14, 16, 22, 42, 52, 58, 68, 71	24 ea	20.80/0.85
43006 $\Delta$ <b>C</b>	7.25" Salad Plate	02, 09, 14, 22, 42, 52	48 ea	25.10/0.78
43008 $\Delta$	6.5" Pie Plate	02, 03, 09, 14, 22, 42, 52, 71	48 ea	21.60/0.66
<b>Durus Wide Rim Plates</b>				
43024 $\Delta$	12" Dinner Plate	02	12 ea	18.10/0.54
43010 $\Delta$	10.5" Dinner Plate	02, 14, 22, 42, 52	12 ea	12.30/0.42
43012 $\Delta$	9" Dinner Plate	02, 03, 09, 14, 22, 42, 52	24 ea	20.25/0.76
43016 $\Delta$	7.5" Salad Plate	02, 09, 14, 22, 42	48 ea	26.90/0.96
43018 $\Delta$	6.5" Pie Plate	02, 09, 14, 22, 42, 52	48 ea	20.64/0.70
<b>Durus Oval Platters</b>				
43080 $\Delta$	13.5" x 10.5" Oval Platter	02, 09, 14, 22, 42, 52, 71	12 ea	15.00/0.59
43082 $\Delta$ <b>C</b>	12" x 9.25" Oval Platter	02, 03, 09, 14, 16, 22, 42, 52, 58, 71, 77	12 ea	14.10/0.55
43086 $\Delta$	9.5" x 7.25" Oval Platter	02, 03, 09, 14, 22, 42, 52, 58, 71	24 ea	18.00/0.60
<b>Durus Bowls &amp; Cup</b>				
43030 $\Delta$	20 oz, 12" Chef Salad/Pasta Bowl	02, 03, 09, 14, 16, 22, 42, 52, 58, 68	12 ea	16.30/0.71
43032 $\Delta$	16 oz, 7.5" Rimmed Bowl	02, 03, 09, 14, 22, 42, 52	24 ea	14.10/0.58
43034 $\Delta$	13 oz, 9.25" Pasta/Soup/Salad Bowl	02, 09, 14, 22, 42, 52, 58, 68	24 ea	21.60/0.82
43036 $\Delta$	12 oz, 7.25" Rimmed Bowl	02, 09, 14, 22, 42, 52, 71	24 ea	16.10/0.62
43038 $\Delta$	10 oz, 5.38" Rimmed Nappie Bowl	02, 09, 14, 22, 42, 52	24 ea	11.50/0.52
43040 $\Delta$	6 oz, 6" Rimmed Bowl	02, 09, 14, 22, 42, 52	48 ea	21.45/0.72
43042 $\Delta$ <b>C</b>	4.5 oz, 4.75" Rimmed Fruit Bowl	02, 09, 14, 16, 22, 42, 52, 58, 68, 71	48 ea	12.86/0.42
43050 $\Delta$ <b>C</b>	7 oz, 4" Bouillon Cup	02, 03, 09, 14, 22, 42, 52, 71	48 ea	12.20/0.75

NSF Listed products are designated with a  $\Delta$

Cash ' N Carry products are designated with a **C**

Note: Melamine Dinnerware is not recommended for microwave

# MELAMINE DINNERWARE

## Durus® Designer Patterns

- High quality Durus Dinnerware is available in a wide selection of modern and classic patterns that coordinate with solid color Durus shown on pages 6-7
- 12" Durus Designer Dinner Plates can also be coordinated with our Decorated Palette Designer Displayware shown on pages 62-65
- Mix and match Durus side dishes with china plates for a beautiful tabletop that costs less to maintain
- Safe for temperatures up to 212°F
- NSF Listed; dishwasher safe



\*See page 304 for complete warranty information



Morocco (903)  
(Bone)

Orleans (905)  
(Bone)

Parisian (906)  
(Bone)

Roma (907)  
(Bone)

Sierra Sand (908)  
(Sand)

Versailles (909)  
(Bone)

London (912)  
(White)

Twist (915)  
(White)



Fresco(916)  
(Bone)



Mediterranean Tile(918)  
(White)



Modern Squares(919)  
(White)



Himalayan(920)  
(White)



Black Waves(921)  
(White)



Tan Waves(922)  
(White)



Prod No	Description	Color	Pack	Cs Wt/Cube
<b>Durus Decorated Narrow Rim Plates</b>				
43003 <span style="color: blue;">▲</span>	10.5" Dinner Plate	903, 905, 906, 912	12 ea	11.50/0.51
43005 <span style="color: blue;">▲</span>	9" Dinner Plate	903, 905, 906, 909, 912	24 ea	21.25/0.84
43009 <span style="color: blue;">▲</span>	6.5" Pie Plate	903, 905, 906, 909, 912	48 ea	21.40/0.69
<b>Durus Decorated Wide Rim Plates</b>				
43025 <span style="color: blue;">▲</span>	12" Dinner Plate	915, 916, 918, 919, 920, 921, 922	12 ea	13.50/0.53
43011 <span style="color: blue;">▲</span>	10.5" Dinner Plate	906, 907, 908, 915	12 ea	13.30/0.53
43013 <span style="color: blue;">▲</span>	9" Dinner Plate	907, 908, 915	24 ea	20.45/0.75
43017 <span style="color: blue;">▲</span>	7.5" Salad Plate	915	48 ea	27.10/0.86
43019 <span style="color: blue;">▲</span>	6.5" Pie Plate	907, 908, 915	48 ea	20.65/0.61
<b>Durus Decorated Oval Platters</b>				
43083 <span style="color: blue;">▲</span>	12" x 9.25" Oval Platter	903, 908, 915	12 ea	14.25/0.56
43087 <span style="color: blue;">▲</span>	9.5" x 7.25" Oval Platter	908, 915	24 ea	17.80/0.63
<b>Durus Decorated Bowls</b>				
43031 <span style="color: blue;">▲</span>	20 oz, 12" Chef Salad/Pasta Bowl	906, 907	12 ea	16.20/0.74
43037 <span style="color: blue;">▲</span>	12 oz, 7.25" Rimmed Bowl	903, 907, 908, 909, 912	24 ea	16.20/0.62
43041 <span style="color: blue;">▲</span>	8 oz, 6" Rimmed Bowl	908	48 ea	21.45/0.66
43043 <span style="color: blue;">▲</span>	4.5 oz, 4.75" Rimmed Fruit Bowl	903, 907, 908, 909, 912	48 ea	12.90/0.44

NSF Listed products are designated with a ▲  
 Note: Melamine Dinnerware is not recommended for microwave



# MELAMINE DINNERWARE

## Sierrus™ Dinnerware

- All purpose, medium-heavy weight dinnerware has the same design as our Durus® line
- Available in eight solid colors
- Sierrus Dinnerware offers a two-year warranty against breakage
- Made of heavy-duty, break-resistant melamine
- Safe for temperatures up to 212°F
- NSF Listed; dishwasher safe







White(02)



Black(03)



Red(05)



Meadow Green(09)



Ocean Blue(14)



Honey Yellow(22)



Bone(42)



Sunset Orange(52)



White(02)



Black(03)



Red(05)



Meadow Green(09)



Ocean Blue(14)



Honey Yellow(22)



Bone(42)



Sunset Orange(52)

Prod No	Description	Color	Pack	Cs Wt/Cube
<b>Sierras Narrow Rim Plates</b>				
33000 $\Delta$	10.5" 3-Compartment Plate	02, 03, 05, 09, 14, 22, 42, 52	12 ea	9.66/0.39
33002 $\Delta$	10.5" Dinner Plate	02, 03, 05, 09, 14, 22, 42, 52	12 ea	9.19/0.33
33004 $\Delta$	9" Dinner Plate	02, 03, 05, 09, 14, 22, 42, 52	24 ea	15.00/0.66
33006 $\Delta$	7.25" Salad Plate	02, 03, 05, 09, 14, 22, 42, 52	48 ea	19.01/0.61
33008 $\Delta$	6.5" Pie Plate	02, 03, 05, 09, 14, 22, 42, 52	48 ea	15.84/0.56
<b>Sierras Wide Rim Plates</b>				
33024 $\Delta$	12" Dinner Plate	02, 03, 05, 09, 14, 22, 42, 52	12 ea	11.46/0.44
33010 $\Delta$	10.5" Dinner Plate	02, 03, 05, 09, 14, 22, 42, 52	12 ea	10.51/0.40
33012 $\Delta$	9" Dinner Plate	02, 03, 05, 09, 14, 22, 42, 52	24 ea	15.05/0.62
33016 $\Delta$	7.5" Salad Plate	02, 03, 05, 09, 14, 22, 42, 52	48 ea	21.33/0.71
33018 $\Delta$	6.5" Pie Plate	02, 03, 05, 09, 14, 22, 42, 52	48 ea	15.63/0.57
33020 $\Delta$	5.5" Bread & Butter Plate	02, 03, 05, 09, 14, 22, 42, 52	48 ea	11.66/0.41
<b>Sierras Platters</b>				
33080 $\Delta$	13.5" x 10.5" Oval Platter	02, 03, 05, 09, 14, 22, 42, 52	12 ea	12.94/0.48
33082 $\Delta$	12" x 9.25" Oval Platter	02, 03, 05, 09, 14, 22, 42, 52	12 ea	10.06/0.42
33086 $\Delta$	9.5" x 7.25" Oval Platter	02, 03, 05, 09, 14, 22, 42, 52	24 ea	12.25/0.52
<b>Sierras Bowls &amp; Cup</b>				
33030 $\Delta$	20 oz, 12" Chef Salad/Pasta Bowl	02, 03, 05, 09, 14, 22, 42, 52	12 ea	11.72/0.53
33032 $\Delta$	16 oz, 7.5" Rimmed Bowl	02, 03, 05, 09, 14, 22, 42, 52	24 ea	10.82/0.46
33034 $\Delta$	13 oz, 9.25" Pasta/Soup/Salad Bowl	02, 03, 05, 09, 14, 22, 42, 52	24 ea	17.16/0.66
33036 $\Delta$	12 oz, 7.25" Rimmed Bowl	02, 03, 05, 09, 14, 22, 42, 52	24 ea	13.15/0.54
33038 $\Delta$	10 oz, 5.38" Rimmed Nappie Bowl	02, 03, 05, 09, 14, 22, 42, 52	24 ea	8.34/0.49
33040 $\Delta$	6 oz, 6" Rimmed Bowl	02, 03, 05, 09, 14, 22, 42, 52	48 ea	8.50/0.52
33042 $\Delta$	4.5 oz, 4.75" Rimmed Fruit Bowl	02, 03, 05, 09, 14, 22, 42, 52	48 ea	9.40/0.41
33050 $\Delta$	7 oz, 4" Bouillon Cup	02, 03, 05, 09, 14, 22, 42, 52	48 ea	12.54/0.76

NSF Listed products are designated with a  $\Delta$

Note: Melamine Dinnerware is not recommended for microwave

# MELAMINE DINNERWARE

## Dayton™ Dinnerware

- One of the most environmentally friendly commercial grade melamines available in the market
- Classic design is available in 10 stylish colors
- Meets PS25-70 specifications
- Made from 50% sustainable natural resources vs 20% in standard melamine
- Contains a material that will begin to biodegrade in 90 days in a compostable environment
- Withstands the rigors of commercial foodservice dishwasher use
- Maintains its appearance after one year of dishwasher testing
- Durable melamine is stain, scratch and break-resistant, making it ideal for any foodservice operation
- Safe for temperatures up to 212° F
- NSF Listed; dishwasher safe



## Balsam Displayware Compliments The Dayton Dinnerware Line

- Balsam & Dayton are made from one of the most environmentally friendly commercial grade melamines available in the market
- For a complete listing of Balsam Displayware, see page 58





Prod No	Description	Color	Pack	Cs Wt/Cube
<b>Dayton Dinnerware Plates &amp; Platters</b>				
43850 $\Delta$	10.25" Dinner Plate	03, 05, 06, 22, 31, 37, 40, 43, 63, 82	48 ea	34.89/1.42
43852 $\Delta$	9" Dinner Plate	03, 05, 06, 22, 31, 37, 40, 43, 63, 82	48 ea	27.29/0.82
43854 $\Delta$	7.25" Salad Plate	03, 05, 06, 22, 31, 37, 40, 43, 63, 82	48 ea	17.18/0.44
43856 $\Delta$	5.63" Bread & Butter Plate	03, 05, 06, 22, 31, 37, 40, 43, 63, 82	48 ea	10.68/0.30
43872 $\Delta$	9.25" x 6.25" Oval Platter	03, 05, 06, 22, 31, 37, 40, 43, 63, 82	24 ea	10.66/0.33
<b>Dayton Dinnerware Bowls &amp; Cup</b>				
43858 $\Delta$	16 oz, 5.75" Nappie Bowl	03, 05, 06, 22, 31, 37, 40, 43, 63, 82	48 ea	16.95/0.87
43860 $\Delta$	14 oz, 5.5" Rim Nappie Bowl	03, 05, 06, 22, 31, 37, 40, 43, 63, 82	24 ea	8.74/0.45
43862 $\Delta$	10 oz, 5" Nappie Bowl	03, 05, 06, 22, 31, 37, 40, 43, 63, 82	48 ea	11.14/0.50
43864 $\Delta$	10 oz, 5.88" Grapefruit Bowl	03, 05, 06, 22, 31, 37, 40, 43, 63, 82	48 ea	15.01/0.62
43866 $\Delta$	4.75 oz, 4.5" Fruit Bowl	03, 05, 06, 22, 31, 37, 40, 43, 63, 82	48 ea	7.37/0.31
43868 $\Delta$	8 oz, 3.75" Bouillon Cup	03, 05, 06, 22, 31, 37, 40, 43, 63, 82	24 ea	5.32/0.18

NSF Listed products are designated with a  $\Delta$

Note: Melamine Dinnerware is not recommended for microwave



# MELAMINE DINNERWARE

## Dallas Ware® Dinnerware

- Dallas Ware, the original industry standard for melamine dinnerware, offers superior stain and scratch resistance
- Reinforced rim and foot design stacks with major competitors' products
- Meets PS25-70 specifications
- Safe for temperatures up to 212°F
- NSF Listed; dishwasher safe

43529  
43503



Tabletop Accessories available in coordinating Caribbean colors.  
See page 53 for more details.  
Coordinating ramekins in Caribbean colors also available on pages 46 & 47.



### Cash 'N Carry

Selected products also available in a cash 'n carry pack. See page 274.



### Standard Colors





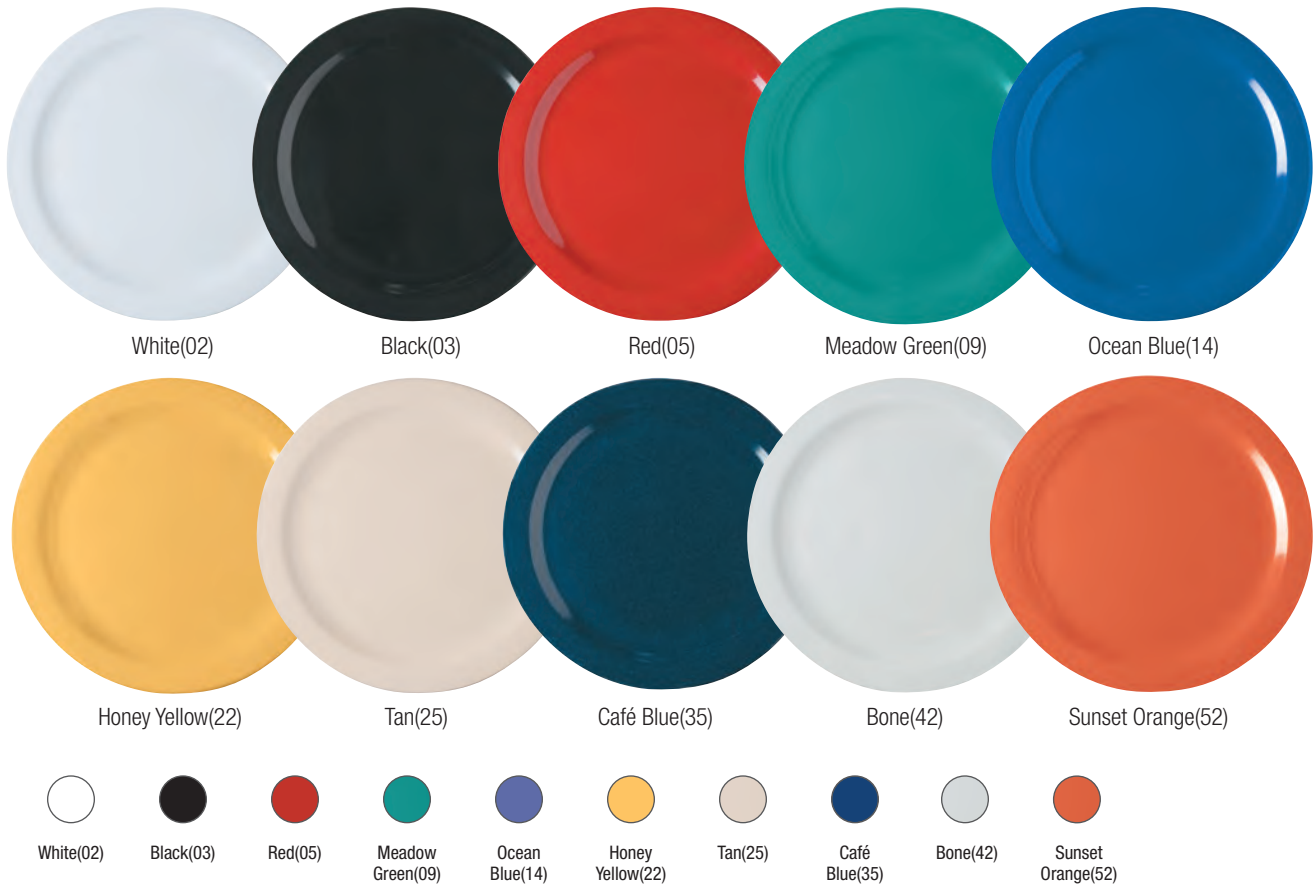

Prod No	Description	Color	Pack	Cs Wt/Cube
<b>Dallas Ware Narrow Rim Plates</b>				
43500 <b>Δ C</b>	10.25" Dinner Plate	02, 03, 05, 09, 14, 22, 25, 35, 42, 52	48 ea	39.60/1.63
43501 <b>Δ C</b>	9" Dinner Plate	02, 03, 05, 09, 14, 22, 25, 35, 42, 52	48 ea	26.55/0.99
43503 <b>Δ</b>	7.25" Salad Plate	02, 03, 05, 09, 14, 22, 25, 35, 42, 52	48 ea	16.20/0.51
43504 <b>Δ</b>	6.5" Pie Plate	02, 25	48 ea	12.80/0.42
43505 <b>Δ</b>	5.63" Bread & Butter Plate	02, 25, 35	48 ea	9.80/0.31
<b>Dallas Ware Compartment Plates</b>				
43512 <b>Δ</b>	11", 1" D, 3-Compartment Plate	35	48 ea	37.60/1.60
43514 <b>Δ</b>	9.75", 1" D, 3-Compartment Plate	25, 35	36 ea	27.80/1.56
43516 <b>Δ</b>	9", 1.31" D, 3-Compartment Plate	02, 25	24 ea	20.05/1.20
<b>Dallas Ware Oval Platters</b>				
43560 <b>Δ C</b>	12" x 8.5" Oval Platter	02, 03, 25, 35	24 ea	15.00/0.76
43563 <b>Δ C</b>	9.25" x 6.25" Oval Platter	02, 03, 25, 35, 42	24 ea	10.44/0.37
<b>Dallas Ware Bowls</b>				
43520 <b>Δ C</b>	16 oz, 5.75" Nappie Bowl	02, 25	48 ea	16.50/0.93
43521 <b>Δ</b>	14 oz, 5.5" Nappie Bowl	02, 03, 05, 09, 14, 22, 25, 35, 42, 52	48 ea	13.75/0.66
43522 <b>Δ</b>	14 oz, 5.5" Rim Nappie Bowl	02, 25, 35	24 ea	8.00/0.47
43525 <b>Δ</b>	13 oz, 5.25" Nappie Bowl	02, 25, 35	24 ea	6.30/0.33
43528 <b>Δ</b>	10 oz, 5" Nappie Bowl	02, 25, 35	48 ea	11.10/0.54
43529 <b>Δ</b>	10 oz, 5.88" Grapefruit Bowl	02, 03, 05, 09, 14, 22, 25, 35, 42, 52	48 ea	14.83/0.67
43531 <b>Δ C</b>	4.75 oz, 4.5" Fruit Bowl	02, 25, 35	48 ea	7.10/0.40
43532 <b>Δ</b>	3.5 oz, 4.13" Fruit Bowl	02, 03, 05, 25, 35	48 ea	6.20/0.29
43533 <b>Δ</b>	6.5 oz Oval Fruit Dish	02	48 ea	10.25/0.41
43540 <b>Δ C</b>	8 oz, 3.75" Bouillon Cup	02, 03, 05, 09, 14, 22, 25, 35, 42, 52	24 ea	4.45/0.19

NSF Listed products are designated with a **Δ**

Cash 'N Carry products are designated with a **C**

Note: Melamine Dinnerware is not recommended for microwave

# MELAMINE DINNERWARE

## Kingline™ Dinnerware

- All purpose medium weight dinnerware meets the tough requirements of heavy-duty foodservice applications
- Durable gloss finish resists chipping, scratching and staining
- Reinforced at vital stress points
- Save even more money with our exclusive Sandshades® variegated dinnerware
- Safe for temperatures up to 212°F
- NSF Listed; dishwasher safe





Shown L to R: White(02), Black(03), Red(05), Tan(25), Adobe(70), Sandshades(92)



Prod No	Description	Color	Pack	Cs Wt/Cube
<b>Kingline Plates</b>				
KL116 $\Delta$	10" Dinner Plate	02, 03, 05, 25	48 ea	25.80/1.07
KL200 $\Delta$	9" Dinner Plate	02, 03, 05, 25, 70	48 ea	19.20/0.88
KL920 $\Delta$	9" Dinner Plate	92	48 ea	18.50/0.82
KL201 $\Delta$	7.25" Sandwich Plate	02, 03, 05, 25	48 ea	12.20/0.56
KL204 $\Delta$	6.5" Pie Plate	02, 03, 05, 25	48 ea	11.35/0.40
KL205 $\Delta$	5.5" Bread & Butter Plate	02, 25, 70	48 ea	8.65/0.28
<b>Kingline Compartment Plates</b>				
KL102 $\Delta$	10", .75" D, 3-Compartment Plate	02, 25, 70	48 ea	24.30/1.23
KL203 $\Delta$	8.75", 1.25" D, 3-Compartment Plate	02, 25	12 ea	7.85/0.57
<b>Kingline Oval Platters</b>				
KL126 $\Delta$	13.5" x 9.75" Oval Platter	02, 25	12 ea	10.40/0.55
KL127 $\Delta$	12" x 9" Oval Platter	02, 03, 05, 25, 70	12 ea	8.90/0.42
<b>Kingline Bowls &amp; Cup</b>				
KL350 $\Delta$	8 oz Bouillon Cup	02, 03, 05, 25	48 ea	8.20/0.54
KL115 $\Delta$	16 oz, 6.13" Chowder Bowl	02, 25	48 ea	15.70/0.94
KL108 $\Delta$	14 oz, 5.5" Nappie Bowl	02, 25	48 ea	11.90/0.75
KL119 $\Delta$	12.5 oz, 5.5" Rimmed Nappie Bowl	02, 25, 70	48 ea	14.65/0.78
KL924 $\Delta$	12.5 oz, 5.5" Rimmed Nappie Bowl	92	48 ea	14.02/0.88
KL121 $\Delta$	10 oz, 5.88" Grapefruit Bowl	02, 25	48 ea	12.50/0.51
KL118 $\Delta$	10 oz, 5.13" Nappie Bowl	02, 03, 05, 25	48 ea	10.80/0.68
KL123 $\Delta$	8 oz, 7.75" Wide Rimmed Salad Bowl	02	48 ea	19.00/0.92
KL800 $\Delta$	5 oz, 5" Rimmed Fruit Bowl	02, 25, 70	48 ea	8.30/0.27
KL805 $\Delta$	4.75 oz, 4.5" Rimmed Fruit Bowl	02, 03, 05, 25	48 ea	7.20/0.32
KL928 $\Delta$	4.75 oz, 4.25" Rimmed Fruit Bowl	92	48 ea	7.15/0.31

NSF Listed products are designated with a  $\Delta$

Note: Melamine Dinnerware is not recommended for microwave

\* Sandshades items vary in color, hue, and intensity from piece to piece

# MELAMINE DINNERWARE

## Terra™ Dinnerware

- The look of heavy-weight, hand thrown pottery blends into a variety of settings and offers an exceptional presentation
- Constructed of a unique break-resistant material with the look and feel of ceramic
- Safe for temperatures up to 212°F
- NSF Listed; dishwasher safe



43420



43422



43410

43404

## Square Dinnerware

- Squares offer the look of ceramics in long-wearing melamine
- Five sizes hold everything from salads and appetizers to buffet style presentations
- Squared rim design is a sleek take on a classic look
- Made of heavy-duty, break-resistant melamine
- Safe for temperatures up to 212°F
- NSF Listed; dishwasher safe



43304



43302  
43300



43306 shown  
with 7940



## Epicure® Dinnerware

- European coupe design combines strength and beauty with functionality
- Coupe design offers larger serving area
- Safe for temperatures up to 212°F
- NSF Listed; dishwasher safe



43813  
43801



43800

5933  
43803

43814



White(02)

Black(03)

Prod No	Description	Color	Pack	Cs Wt/Cube
<b>Terra Dinnerware</b>				
43404 $\Delta$	9.5" Terra Dinner Plate	02,03	12 ea	15.20/0.60
43410 $\Delta$	9" Terra Square Plate	02,03	24 ea	21.60/0.84
43420 $\Delta$	58 oz, 9.75" Terra Footed Bowl Pack	02,03	12 ea	20.60/1.05
43422 $\Delta$	40 oz, 8.5" Terra Footed Bowl	02,03	12 ea	21.20/0.76
<b>Square Dinnerware</b>				
43308 $\Delta$	8" Square Plate	02,03	48 ea	22.75/0.48
43306 $\Delta$	9.5" Square Plate	02,03	48 ea	34.68/0.71
43304 $\Delta$	11.5" Square Plate	02,03	48 ea	46.51/1.03
43302 $\Delta$	13.5" Square Plate	03	12 ea	18.26/0.87
43300 $\Delta$	15.5" Square Plate	02,03	12 ea	24.33/1.07
<b>Epicure Dinnerware</b>				
43800 $\Delta$	12" Buffet/Pizza Plate	02	12 ea	12.50/0.74
43801 $\Delta$	10" Dinner Plate	02	48 ea	29.15/1.28
43803 $\Delta$	8" Dinner Plate	02	48 ea	15.98/0.67
5933 $\Delta$	32 oz, 8.25" Vegetable Bowl	02	24 ea	17.75/1.28
43813 $\Delta$	40 oz, 8" Chef Salad/Serving Bowl	02	12 ea	5.95/0.38
43814 $\Delta$	20 oz, 6.5" Soup/Salad Bowl	02	12 ea	4.00/0.18

NSF Listed products are designated with a  $\Delta$

Note: Melamine Dinnerware is not recommended for microwave

## PAPER PRODUCTS

### Custom Placemat Designs

Let Carlisle design a special placemat, customized exclusively for you. Placemats feature high quality paper and graphics, and are printed using soy based ink.



### Custom Napkin Designs

Carlisle facial quality 2-ply napkins let you coordinate a colorful and attractive display for every setting.

- Dinner Napkins
- Cocktail Napkins
- Trimline Napkins



Minimum order quantities apply for custom designs. Six week lead time needed for production. Contact your sales representative for additional information.

## The Cutlery Caddy

The Cutlery Caddy is a unique printed sleeve pre-loaded with a 2-ply 16" x 16" Trimline facial quality tissue napkin. Utensils can then be inserted for a clean, sanitary presentation with an upscale look. Two colors are available with the Bon Appetit design, as well as our Filigree pattern. The kid's "Surprise Kit" is printed with line art and each case contains colored pencils for after meal fun.

- Cuts labor costs for wrapping utensils
- Perfect for catering
- Room to insert catering condiments
- Can be used with stainless or plastic utensils
- Ask your sales representative about custom cutlery caddies



## Utensil, Coffee and Condiment Kits

- Perfect for catering, take out, room service and in-room coffee stations
- Condiments, napkins, straws, and cutlery are sealed for sanitation and freshness
- Available in any configuration
- Ask your sales representative about customized kits



The CaféKit includes sugar, sugar sub, creamer, coffee stirrers and a 2-ply napkin.



The utensil kit includes black heavy-weight knife, fork and teaspoon.

For a complete list of paper products, see the Carlisle | Dinet catalog or visit our online catalog [www.carlislefsp.com](http://www.carlislefsp.com).



# DINNERWARE



## Commercial Dinnerware

- Designed for corrections, hospitals, schools, long term care facilities, or anywhere long product life and economy are important
- Super-tough polycarbonate dinnerware offers a five-year guarantee against breakage
- Polycarbonate material resists stains and chipping
- Plates have scratch-resistant textured surface
- Stacks with other polycarbonate dinnerware currently on the market
- Temperature use range: -40° to 212°F
- NSF Listed; dishwasher safe



Prod No	Description	Color	Pack	Cs Wt/Cube
<b>Commercial Dinnerware Plates</b>				
PCD210 $\Delta$	10" Narrow Rim Plate	02, 03, 25, 50, 56, 59	48 ea	23.35/0.83
PCD209 $\Delta$	9" Narrow Rim Plate	02, 03, 15, 25, 50, 56, 59	48 ea	17.20/0.58
PCD207 $\Delta$	7.25" Narrow Rim Plate	25	48 ea	11.75/0.34
PCD206 $\Delta$	6.5" Narrow Rim Plate	02, 03, 50, 56, 59	48 ea	10.00/0.36
PCD205 $\Delta$	5.5" Narrow Rim Plate	02, 03	48 ea	6.50/0.23
<b>Commercial Dinnerware Compartment Plates</b>				
PCD211 $\Delta$	11" Narrow Rim 3-Compartment Plate, 1.25" deep	03, 25	48 ea	26.69/0.89
PCD220 $\Delta$	9" Narrow Rim 3-Compartment Plate, 1" deep	02, 59	48 ea	18.70/0.82
<b>Commercial Dinnerware Oval Platter</b>				
PCD412 $\Delta$	12" x 9" Oval Platter	02, 03, 50	24 ea	11.30/0.40
<b>Commercial Dinnerware Bowls &amp; Cup</b>				
PCD319 $\Delta$	15 oz, 5.25" Nappie Bowl	02, 03, 25, 50	48 ea	10.99/0.61
PCD312 $\Delta$	12 oz, 9" Soup Bowl	02, 03, 59	48 ea	19.00/0.82
PCD310 $\Delta$	10 oz, 4" Square Bowl	02	48 ea	6.24/0.46
PCD313 $\Delta$	10 oz, 6" Rimmed Grapefruit Bowl	02, 03, 59	48 ea	11.60/0.56
PCD316 $\Delta$	10 oz, 5" Nappie Bowl	03	48 ea	7.45/0.60
PCD308 $\Delta$	8.4 oz, 4" Bouillon Cup	02, 15	48 ea	5.35/0.27
PCD305 $\Delta$	5 oz, 3.5" Rimmed Fruit Bowl	02, 03, 15, 25, 50, 56, 59	48 ea	5.62/0.33
<b>Commercial Dinnerware Mug</b>				
PCD796 $\Delta$	9.6 oz Mug	02, 25	48 ea	11.65/1.46

NSF Listed products are designated with a  $\Delta$



### Tulip Dishes

- Ideal for serving ice cream, puddings, salads and more
- Stack with similar glass or plastic dessert dishes
- Made of break-resistant SAN
- 4532, 4534 are also available in extra-durable polycarbonate
- Tulip Dishes are the perfect compliment to the Coldmaster® Ice Cream Server shown on page 94
- NSF Listed; dishwasher safe



**Cash 'N Carry**  
Selected products also available in a cash 'n carry pack. See page 274.

### Small Plates

- Serving pieces are great for finger foods, desserts, appetizers or side dishes
- All plates offer the following features:
- Heavy-weight, break-resistant melamine
  - Enjoy the look and feel of china without the replacement cost
  - Safe for temperatures up to 212°F
  - NSF Listed; dishwasher safe

### Square Scoops

- Scoop shaped design holds sauces as well as appetizers or side dishes
- Compliments our Square Dinnerware shown on page 18

### Epicure® Shapes

- One of a kind shapes add variety when serving appetizers, desserts, or speciality foods

Prod No	Description	Color	Pack	Cs Wt/Cube
<b>Tulip Dishes</b>				
4530 <b>Δ C</b>	5 oz, 3.75" SAN Tulip Dessert Dish	03, 07, 42, 54, 55	24 ea	2.76/0.22
4532 <b>Δ</b>	5 oz, 3.75" PC Tulip Dessert Dish	07	24 ea	3.12/0.21
4531 <b>Δ C</b>	5 oz, 4.63" SAN Tulip Berry Dish	03, 07, 42	24 ea	3.00/0.23
4535 <b>Δ</b>	8 oz, 4.63" SAN Tulip Berry Dish	07	48 ea	8.70/0.69
4533 <b>Δ</b>	13 oz, 5.5" SAN Tulip Bowl	07	24 ea	5.86/0.38
4534 <b>Δ</b>	13 oz, 5.5" PC Tulip Bowl	07	24 ea	5.86/0.38
<b>Square Scoops</b>				
7940 <b>Δ</b>	2 oz, 3.5" Small Square Dish	02, 03	48 ea	7.12/0.21
7942 <b>Δ</b>	5 oz, 5.25" Small Square Dish	02, 03	48 ea	12.93/0.47
<b>Epicure Shapes</b>				
43806 <b>Δ</b>	11" TriArc Plate	02, 03	4 ea	3.60/0.21
42824 <b>Δ</b>	10.5" Wide Rim Soup Plate	02, 03	12 ea	14.20/0.42
43822 <b>Δ</b>	6.25" Square Plate	02	48 ea	26.30/0.68
43470 <b>Δ</b>	8" Delta Plate	02	48 ea	23.00/0.74

NSF Listed products are designated with a **Δ**  
Cash 'N Carry products are designated with a **C**



## PLATES & BOWLS

### Petal Mist® Plates & Bowls

- Perfect for buffets, food bars, delis, poolside, and catering
- Made of tough, break-resistant polycarbonate
- Textured exterior hides scratches; smooth interior is easy to clean
- Safe for use in freezers and in temperatures from 40° to 212°F
- See page 74 for additional Petal Mist trays and bowls
- NSF Listed; dishwasher safe



### Cash 'N Carry

Selected products also available in a cash 'n carry pack. See page 274.

### Leaf Plates

- Intricate leaf pattern enhances food appearance
- Molded of durable SAN for long life
- Dishwasher safe



### Charger Plates

- Beautiful mirror-finish charger plates are an elegant addition to any place setting
- Easy care tarnish-resistant finish
- Handwash only



### Woodgrain Salad Bowls

- SAN bowls provide economical, break-resistant service
- Wood grain finish with smooth interior



43816



650B

800M

500M  
500B

575B

### Bell Bowl

- Heavy-weight melamine single serving bowls
- Use with large size bell bowls shown on page 74
- NSF Listed; dishwasher safe

### Melamine Salad Bowls

- Made of dependable, impact-resistant melamine
- Safe for temperatures up to 212°F
- NSF Listed; dishwasher safe



Prod No	Description	Color	Pack	Cs Wt/Cube
<b>Petal Mist Plates &amp; Bowls</b>				
6904 $\Delta$ <b>C</b>	18 oz, 6" Petal Mist Bowl	03, 07	36 ea	7.31/0.53
6954 $\Delta$ <b>C</b>	7.5" Petal Mist Plate	07	36 ea	10.35/0.47
6907 $\Delta$ <b>C</b>	23.9 oz, 8" Petal Mist Soup/Salad Plate	07, 48	36 ea	12.65/0.60
6956 $\Delta$ <b>C</b>	9" Petal Mist Plate	07	36 ea	13.39/0.67
<b>Leaf Plates</b>				
0345	6" Leaf Plate	07	36 ea	13.50/0.73
0347	9" Leaf Plate	07	12 ea	8.56/0.57
<b>Charger Plates</b>				
608924	12.25" Charger Plate, Chrome	-	12 ea	10.50/0.22
608925	12.25" Charger Plate, Brass	-	12 ea	10.50/0.24
<b>Woodgrain Salad Bowls</b>				
7055	10 oz, 5.5" Woodgrain Salad Bowl	20	72 ea	7.99/0.46
7060	13 oz, 6" Woodgrain Salad Bowl	03, 11	72 ea	13.18/0.46
7080	1.1 qt, 8" Woodgrain Salad Bowl	03, 11, 20	72 ea	37.37/1.87
<b>Bell Bowl</b>				
43816 $\Delta$	12 oz, 6" Melamine Salad/Serving Bowl	03	48 ea	13.60/0.61
<b>Melamine Salad Bowls</b>				
500B $\Delta$	10 oz, 5.5" Melamine Salad Bowl	03	72 ea	11.02/0.45
575B $\Delta$	13 oz, 6" Melamine Salad Bowl	03	72 ea	10.01/0.37
650B $\Delta$	20 oz, 6.5" Melamine Salad Bowl	03	72 ea	21.02/0.96
800B $\Delta$	27 oz, 7.5" Melamine Salad Bowl	03	48 ea	19.92/1.01
500M $\Delta$	10 oz, 5.5" Melamine Salad Bowl	20*	72 ea	11.09/0.45
575M $\Delta$	13 oz, 6" Melamine Salad Bowl	20*	72 ea	10.37/0.35
650M $\Delta$	20 oz, 6.5" Melamine Salad Bowl	20*	72 ea	21.02/0.96
800M $\Delta$	27 oz, 7.5" Melamine Salad Bowl	20*	48 ea	19.82/0.94

NSF Listed products are designated with a  $\Delta$

Cash 'N Carry products are designated with a **C**

# PLATE COVERS

## Polyglass Plate Covers

- Available to fit a wide variety of plate sizes and footprints
- Polyglass (PG) plate covers are designed for use in microwaves and heated carts
- Heat resistant to 300°F yet stays cool to the touch; excellent insulation properties
- Impact-resistant material offers a superior alternative to standard fiberglass covers
- NSF Listed; dishwasher safe



## Polycarbonate Plate Covers

- Clear covers for easy viewing of food
- Highly heat- and break-resistant
- 1960 and 1992 also fit European “pin-fired” footless style plates for secure stacking
- Can be used in heated carts or under heat lamps up to 212°F
- Dishwasher safe



## Custom Acrylic Plate Covers

- Excellent for keeping food warm
- Made to order for under- or oversized plates and platters
- Use for table service or patient serving
- Dishwasher safe up to 180°F

## Custom Plate Covers —

### Ordering information

- Minimum order – four dozen (48 ea)
- Two samples of each item are required for quote
- Please allow four to six (4-6) weeks for delivery of samples
- Custom plate cover orders require customer approval of samples prior to production
- If cover has not been previously molded, additional tooling charges apply
- A size variance of .13" is possible in the manufacturing of this product
- Larger and smaller sizes of custom covers by special quotation only
- Custom covers are not returnable



Translucent  
White(02)

Clear(07)



Bone(202)



Gray(203)

Prod No	Description	Color	Pack	Cs Wt/Cube
<b>Polyglass Plate Covers</b>				
91020 $\Delta$	8.75" – 9.13" Polyglass Cover	202	12 ea	12.00/0.46
91040 $\Delta$	9.5" – 10" Polyglass Cover	202	12 ea	12.00/0.62
91055 $\Delta$	10.13" – 10.5" Polyglass Cover	202	12 ea	12.00/0.49
91070 $\Delta$	10.25" – 10.63" Polyglass Cover	202	12 ea	12.00/0.49
91065 $\Delta$	10.13" – 10.38" Polyglass Cover	202	12 ea	16.14/0.61
91080 $\Delta$	10.5" – 10.75" Polyglass Cover	202, 203	12 ea	17.54/0.61
91075 $\Delta$	10.63" – 10.69" Polyglass Cover	202	12 ea	16.89/0.61
91085 $\Delta$	11" – 11.25" Polyglass Cover	202	12 ea	20.42/0.88
91090 $\Delta$	11.75" – 12" Polyglass Cover	202	12 ea	21.59/0.88
91095 $\Delta$	12" – 12.25" Polyglass Cover	202	12 ea	21.91/0.88
<b>Polycarbonate Plate Covers</b>				
1900	8.69" to 9.13" PC Cover	07	12 ea	6.20/0.86
1960	9" Combination "Pin-Fired" Plate & Bowl PC Cover	07	12 ea	9.00/1.05
1965	9.44" to 9.75" PC Cover	07	12 ea	7.70/0.86
1987	9.81" to 10" PC Cover	07	12 ea	7.20/0.86
1989	10.81" to 10.25" PC Cover	07	12 ea	10.30/0.82
1991 $\Delta$	10.5" to 10.63" PC Cover	07	12 ea	10.10/1.14
1992 $\Delta$	10.5" to 10.63" "Pin-Fired" PC Cover	07	12 ea	10.10/1.14
1993	10.75" to 11" PC Cover	07	12 ea	8.80/1.74
1994	12" PC Cover	07	12 ea	8.65/0.96
<b>Custom Acrylic Clear Round Plate Covers</b>				
Group A	7" And Under Acrylic Round Cover	07	24 ea	10.00/0.79
Group B	7.06"–8" Acrylic Round Cover	07	24 ea	12.00/0.79
Group C	8.06"–10" Acrylic Round Cover	07	24 ea	16.00/1.73
Group D	10.06"–14" Acrylic Round Cover	07	24 ea	21.00/2.93
Group E	14.06"–16" Acrylic Round Cover	07	24 ea	23.00/3.78
<b>Custom Acrylic Translucent Round Plate Covers</b>				
Group AT	7" And Under Acrylic Round Cover	02	24 ea	10.00/0.79
Group BT	7.06"–8" Acrylic Round Cover	02	24 ea	12.00/0.79
Group CT	8.06"–10" Acrylic Round Cover	02	24 ea	16.00/1.27
Group DT	10.06"–14" Acrylic Round Cover	02	24 ea	21.00/2.93
Group ET	14.06"–16" Acrylic Round Cover	02	24 ea	23.00/2.37
<b>Custom Acrylic Clear Oval Plate Covers</b>				
Group P1	11" And Under Acrylic Oval Cover	07	24 ea	10.00/1.73
Group P2	11.06"–12.5" Acrylic Oval Cover	07	24 ea	15.00/2.93
Group P3	12.56"–14" Acrylic Oval Cover	07	24 ea	21.00/3.78
Group P4	14.06"–16" Acrylic Oval Cover	07	24 ea	23.00/3.78
<b>Custom Acrylic Translucent Oval Plate Covers</b>				
Group P1T	11" And Under Acrylic Oval Cover	02	24 ea	10.00/0.79
Group P2T	11.06"–12.5" Acrylic Oval Cover	02	24 ea	15.00/2.93
Group P3T	12.56"–14" Acrylic Oval Cover	02	24 ea	21.00/2.68
Group P4T	14.06"–16" Acrylic Oval Cover	02	24 ea	23.00/2.60

NSF Listed products are designated with a  $\Delta$ 

Note: Do not use Acrylic Plate Covers in heated carts, under heat lamps,  
or near exposed heat sources; safe for temperatures under 130°F

# SERVING PIECES

## Microwave-Ware

- Polycarbonate serving accessories designed specifically for microwave cooking
- Stays cool to the touch when coming out of the microwave
- Extremely impact resistant
- Small 8 oz Casserole is perfect for salads and sides - easily doubles as an olive, nut, or butter dish on buffets
- Temperature use range: -40° to 212°F
- Dishwasher safe



## Soup Service

- Hefty, thick-walled designs keep food and beverages hot
- Stackable 12 oz Jumbo Soup/Latté Mug (4512) has polycarbonate inner liner and SAN exterior

## Melamine Bean Pot

- Extra-thick, heavy weight melamine maintains temperatures longer than traditional ceramic
- Classic styled Bean Pot's 8 ounce size is perfect for soups, chili, and other pre-heated sides
- Safe for temperatures up to 212°F
- NSF Listed; dishwasher safe



White(02)



Black(03)



Meadow Green(09)



Ocean Blue(14)



Stone(19)



Honey Yellow(22)



Lenox Brown(28)



Sunset Orange(52)



Chocolate/Bone(438)

Prod No	Description	Color	Pack	Cs Wt/Cube
<b>Microwave-Ware</b>				
7400 $\Delta$	12 oz, 5.25" x 8.75" Oval Casserole	02	24 ea	9.79/0.44
7405 $\Delta$	8 oz, 4.25" x 7.5" Oval Casserole Dish	02, 03	24 ea	24.00/0.40
7410	10 oz, 4" Jumbo Soup Mug	02	24 ea	10.63/0.89
7420	12 oz, 5.25" Handled Soup Bowl	02	24 ea	13.06/1.40
<b>Soup Service</b>				
7006	8 oz, 4.63" Handled Soup Bowl	09, 14, 19, 22, 28, 52	24 ea	7.80/0.53
7008	14 oz, 5.25" Handled Soup Bowl	19, 28	24 ea	11.64/1.40
4512	12 oz, 5.5" Jumbo Soup/Latté Mug with White Liner	19, 28	24 ea	14.16/1.00
7007 $\Delta$	8 oz Melamine Bean Pot	438	24 ea	23.40/0.76

NSF Listed products are designated with a  $\Delta$



# DRINKWARE

Versatility. Durability. Beauty. You'll find them all in Carlisle's drinkware collections. From our attractively designed pitchers and coffee mugs, to glasses in all shapes and sizes, you'll find just what you need to complete your beverage service. Select with confidence — we take pride in delivering the perfect combination of functional beauty and lasting value.

<b>Product</b>	<b>Page</b>	<b>Product</b>	<b>Page</b>
Barware/Drinkware		Tumblers	
Alibi Barware . . . . .	.30	Bistro SAN Tumblers . . . . .	.34
Alibi Stemware . . . . .	.30	Coca-Cola Stackable Tumblers . . . . .	.32
Liberty Drinkware . . . . .	.31	Crystalon Polycarbonate Tumblers In RimGlow Colors . . . . .	.36
Carafe, 2 Cup . . . . .	.39	Crystalon SAN Stack-All Tumblers . . . . .	.35
Coffee Mugs . . . . .	.38	Lafayette Polycarbonate Tumblers . . . . .	.37
Disposable Lids . . . . .	.42	Lexington Polycarbonate Mug . . . . .	.38
Pitchers		Lorraine SAN Tumblers . . . . .	.34
Crystalite Polycarbonate Pitchers . . . . .	.41	Louis SAN Tumblers . . . . .	.34
Élan Polycarbonate Pitcher . . . . .	.41	Pebble Optic SAN Tumblers . . . . .	.33
Polycarbonate Pitchers . . . . .	.40	Polycarbonate Stackable Tumblers . . . . .	.36
Stainless Steel Pitchers . . . . .	.41	Stackable SAN Tumblers . . . . .	.32
VersaPour Polycarbonate Pitchers . . . . .	.40	Swirl Polycarbonate Tumblers . . . . .	.36

# DRINKWARE

## Alibi™ Barware

- Barware is light-weight yet durable SAN
- Great for outdoor & poolside use
- Thick base mimics glass
- Can be decorated, see pages 292-294 for more information
- BPA free
- Dishwasher Safe



## Alibi™ Stemware

- Stemware is shatterproof polycarbonate
- Great for outdoor & poolside service
- Thick base & thin stem mimics traditional glassware
- Can be decorated, see pages 292-294 for more information
- Dishwasher Safe



Shown: 5640, 5644, 5641, 5643, 5646, 5645, 5642



Carlisle's recommended Glass Rack is listed in the product chart



## Liberty™ Drinkware

- Serve poolside drinks without the breakage worries of glass
- Liberty polycarbonate eliminates the need to sacrifice your presentation with disposables
- Can be decorated, see pages 292-294 for more information
- Dishwasher safe



Clear(07)

Prod No	Description	Glass Rack	Color	Pack	Cs Wt/Cube
<b>Alibi Drinkware &amp; Stemware</b>					
5601	1.5 oz Alibi Shot	RG49	07	24 ea	2.46/0.12
5602	2 oz Alibi Shooter	RG49	07	24 ea	1.64/0.09
5603	3 oz Alibi Shooter/Mini Dessert	RG49	07	24 ea	2.09/0.12
5609	9 oz Alibi Rocks/Juice	RG25-1	07	24 ea	5.60/0.48
5610	10 oz Alibi Hi-Ball	RG49-2	07	24 ea	6.50/0.58
5612	12 oz Alibi Double Old Fashion	RW20	07	24 ea	7.92/0.62
5614	14 oz Alibi Beverage	RW30-1	07	24 ea	8.38/0.75
5616	16 oz Alibi Pint/Mixing	RW20-1	07	24 ea	10.50/0.56
5646	9 oz Alibi Martini	RG9-3	07	24 ea	4.64/0.94
5644	6 oz Alibi Champagne Flute	RW30-3	07	24 ea	5.10/1.20
5640	8 oz Alibi Champagne Flute	RE25-5	07	24 ea	3.75/1.46
5643	8 oz Alibi White Wine	RW30-2	07	24 ea	4.20/1.50
5645	11 oz Alibi White Wine	RG16-4	07	24 ea	4.64/0.94
5642	20 oz Alibi Red Wine	RG16-4	07	24 ea	5.87/2.20
5641	22 oz Alibi Balloon	RG16-4	07	24 ea	5.45/2.32
<b>Liberty Drinkware</b>					
43628	8 oz Liberty Old Fashion	RW30	07	24 ea	7.06/0.47
43625	18 oz Liberty Double Old Fashion	RW20-1	07	24 ea	7.20/1.25
43626	22 oz Liberty Hi-Ball	RW20-2	07	24 ea	8.25/1.82
43623	15 oz Liberty Pilsner	RW20-3	07	24 ea	9.40/2.98
43624	9.5 oz Liberty Margarita	RG9-2	07	24 ea	8.20/1.38
43627	8 oz Liberty Martini	RG9-2	07	24 ea	6.55/1.90
43629	9 oz Liberty Cocktail	RG25-2	07	24 ea	8.20/1.38
43620	5 oz Liberty Champagne Flute	RG25-4	07	24 ea	8.20/2.25
43631	15 oz Liberty Hurricane	RG25-4	07	24 ea	7.28/1.31
43630	13 oz Liberty Cocktail	RG25-3	07	24 ea	9.40/2.98
43621	10.5 oz Liberty White Wine	RW20-2	07	24 ea	7.70/1.79
43622	13.5 oz Liberty Goblet	RG16-3	07	24 ea	7.90/1.79

# SAN TUMBLERS

## Stackable SAN Tumblers

- Durable SAN reduces breakage
- Tapered sides make tumblers easy to stack
- Interior lugs prevent jamming when stored
- Textured exterior hides wear and tear
- Stackable Tumblers can be decorated, see pages 292-294 for details
- BPA free
- Dishwasher safe



### Cash 'N Carry

Selected products also available in a cash 'n carry pack. See page 275.



## Coca-Cola® Stackable Tumblers

- Same features as our regular SAN Stackable Tumblers
- Printed with the famous Coca-Cola® trademark in white
- BPA free



52203550A



These items are Trademarked by the Coca-Cola® Company. Coca-Cola® Stackable Tumblers are available for distribution only to authorized Coca-Cola® fountain customers for commercial foodservice use. Coca-Cola® Stackable Tumblers cannot be used for retail sale to the public.



Carlisle's recommended Glass Rack is listed in the product chart

## Pebble Optic™ SAN Tumblers

- Attractive pebbled exterior hides scratches
- Thick-walled SAN construction offers sturdy feel
- 5 oz, 8 oz, 9.5 oz, and 12 oz sizes have stacking feature on bottom
- BPA free
- Dishwasher safe



Prod No	Description	Disposable Lid	Glass Rack	Color	Pack	Cs Wt/Cube
<b>SAN – Large Packs</b>						
5501 C	5 oz SAN Stackable Tumbler	DX1193ST8714*	RG36-1	07, 10, 13	72 ea	6.80/0.52
5526 C	8 oz SAN Stackable Tumbler	—	RG36-1	07, 10, 13, 54	72 ea	8.40/0.64
5529	9 oz Old Fashion SAN Stackable Tumbler	DXTT58*	RG25-1	07, 10, 13	72 ea	11.35/0.85
5506 C	9.5 oz SAN Stackable Tumbler	5506L	RW30	07, 10, 13, 54	72 ea	10.25/0.72
5212 C	12 oz SAN Stackable Tumbler	5212L	RG25-2	07, 10, 13, 47, 54	72 ea	12.45/0.95
5216 C	16 oz SAN Stackable Tumbler	DXTT58*	RG25-2	07, 10, 13, 47, 54	72 ea	15.40/1.12
5220 C	20 oz SAN Stackable Tumbler	DX30008714*	RW20-2	07, 10, 13, 47, 54	72 ea	17.55/1.34
5224 C	24 oz SAN Stackable Tumbler	DXTT45*	RG16-3	07, 10, 13	72 ea	20.10/1.51
5232	32 oz Tall SAN Stackable Tumbler	—	RG16-3	07, 10	24 ea	8.90/0.94
5532 C	32 oz SAN Stackable Tumbler	—	RG16-3	07, 10, 13	48 ea	16.55/1.74
43937	5.5 oz Low Profile SAN Stackable Tumbler	—	RW20	07	72 ea	6.34/0.38
<b>SAN – Small Packs</b>						
5501-2	5 oz SAN Stackable Tumbler	DX1193ST8714*	RG36-1	07	24 ea	2.25/0.18
5526-2	8 oz SAN Stackable Tumbler	—	RG36-1	07	24 ea	2.90/0.23
5529-2	9 oz Old Fashion SAN Stackable Tumbler	DXTT58*	RG25-1	07	24 ea	3.85/0.29
5506-2	9.5 oz SAN Stackable Tumbler	5506L	RW30	07	24 ea	3.40/0.25
5212-2	12 oz SAN Stackable Tumbler	5212L	RG25-2	07	24 ea	4.00/0.33
5216-2	16 oz SAN Stackable Tumbler	DXTT58*	RG16-2	07	24 ea	5.25/0.40
5220-2	20 oz SAN Stackable Tumbler	DX30008714*	RW20-2	07	24 ea	6.20/0.45
<b>Coca-Cola Stackable Tumblers</b>						
52163550E	16 oz Coca-Cola Tumbler, Clear	DXTT58*	RG25-2	—	72 ea	15.40/1.12
52203550A	20 oz Coca-Cola Tumbler, Clear	DX30008714*	RW20-2	—	72 ea	17.55/1.34
52243550G	24 oz Coca-Cola Tumbler, Clear	DXTT45*	RG16-3	—	72 ea	20.30/2.14
5232-63550J	32 oz Coca-Cola Tumbler, Clear	—	RG16-3	—	72 ea	25.63/2.42
52163550D	16 oz Coca-Cola Tumbler, Ruby	DXTT58*	RG25-2	—	72 ea	15.70/1.33
52203550	20 oz Coca-Cola Tumbler, Ruby	DX30008714*	RW20-3	—	72 ea	17.55/1.34
52243550H	24 oz Coca-Cola Tumbler, Ruby	DXTT45*	RG16-3	—	72 ea	20.10/1.51
5232-63550I	32 oz Coca-Cola Tumbler, Ruby	—	RG16-3	—	72 ea	25.63/2.42
<b>Pebble Optic Tumblers</b>						
5505	5 oz Pebble Optic Tumbler	DX24019000*	RG36-1	07	24 ea	3.70/0.49
5508	8 oz Pebble Optic Tumbler	—	RG36-1	07	24 ea	4.75/0.49
5509	9.5 oz Pebble Optic Tumbler	—	RW30	07, 18	24 ea	5.76/0.78
5512	12 oz Pebble Optic Tumbler	DX1198ST8714*	RG36-2	07, 18	24 ea	6.65/0.78
5517	16 oz Pebble Optic Tumbler	—	RG25-2	07, 18	24 ea	7.00/1.03
5519	20 oz Pebble Optic Tumbler	DX11948714	RG25-3	07	24 ea	8.85/1.02

Cash 'N Carry products are designated with a **C**

Note: Please specify case pack when ordering

Note: \*The DX Series Disposable Lids listed above are available through the Carlisle | Dinx Catalog

# SAN TUMBLERS

## Louis™ SAN Tumblers



- Faceted shape offers easy grip
- Appearance of glass
- Made of break-resistant SAN
- Stackable space saving feature
- Tumblers can be decorated, see pages 292-294 for more information
- BPA free
- NSF Listed; dishwasher safe



## Lorraine™ SAN Tumblers



- Attractive panel and facet design
- Made of break-resistant SAN
- 43649 - 9 oz Old Fashion is designed for healthcare tray service, bar or room service
- 43647 - 6 oz size meets healthcare portion standards
- Stacking lugs prevent jamming
- BPA free
- Dishwasher safe



## Bistro™ SAN Tumblers



- Attractive traditional fluted exterior
- Interior lugs prevent jamming when stored
- Made break-resistant SAN
- BPA free
- Dishwasher safe





## Crystalon® SAN Stack-All® Tumblers

- Stylish ribbed texture offers better grip
- Made of break-resistant SAN
- Stacking lugs prevent jamming when stored
- BPA free
- Dishwasher safe

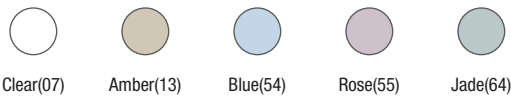

Prod No	Description	Disposable Lid	Glass Rack	Color	Pack	Cs Wt/Cube
<b>Louis SAN Tumblers</b>						
5806 Δ	6 oz Louis Tumbler	—	RW30	07	24 ea	3.12/0.24
5808 Δ	8 oz Louis Rocks	DX22259000*	RG25-1	07	24 ea	4.20/0.37
5810 Δ	10 oz Louis Tumbler	5810L	RW30	07	24 ea	5.07/0.43
5812 Δ	12 oz Louis Rocks	5812L	RW20	07	24 ea	5.40/0.47
5814 Δ	14 oz Louis Tumbler	—	RG25-2	07	24 ea	5.66/0.47
5816 Δ	16 oz Louis Tumbler	DXTT58*	RG25-2	07	24 ea	6.90/0.58
5818 Δ	18 oz Louis Tumbler	—	RW20-1	07	24 ea	6.46/0.56
5820 Δ	20 oz Louis Tumbler	—	RW20-1	07	24 ea	7.86/0.73
5822 Δ	22 oz Louis Tumbler	5822L	RW20-2	07	24 ea	8.19/0.76
5832 Δ	32 oz Louis Tumbler	—	RG16-3	07	24 ea	12.21/1.08
<b>Lorraine SAN Tumblers</b>						
43647	6 oz Lorraine Tumbler	—	RG36-1	07	24 ea	2.93/0.30
43648	8 oz Lorraine Tumbler	1110L	RW30	07	24 ea	3.24/0.30
43649	9 oz Lorraine Old Fashion Tumbler	DXTT59*	RW20	07	24 ea	3.44/0.35
43651	12 oz Lorraine Tumbler	—	RG25-2	07	24 ea	4.38/0.44
43653	16 oz Lorraine Tumbler	DX30008714*	RW20-1	07	24 ea	5.02/0.53
43655	22 oz Lorraine Tumbler	—	RG16-2	07	24 ea	6.04/0.50
<b>Bistro SAN Tumblers</b>						
1104	4 oz Bistro Tumbler	—	RG49-1	07	144 ea	8.64/0.61
1105	5 oz Bistro Tumbler	—	RG36-1	07	144 ea	10.08/0.84
1108	8 oz Bistro Tumbler	—	RW30	07	72 ea	8.14/0.78
1110	10 oz Bistro Tumbler	1110L	RW30	07	72 ea	7.90/0.73
1112	12 oz Bistro Tumbler	1112L	RW30-1	07	72 ea	9.50/0.73
1116	16 oz Bistro Tumbler	—	RG25-2	07	72 ea	11.74/1.01
0120	20 oz Bistro Tumbler	DX21259000*	RW20-2	07	72 ea	14.25/1.33
0132	32 oz Bistro Tumbler	—	RG9-3	07	48 ea	14.25/1.53
<b>Crystalon SAN Stack-All Tumblers</b>						
4008	8 oz Crystalon SAN Tumbler	DX1198ST8714*	RW30	07, 55	48 ea	7.06/0.47
4029	9 oz Old Fashion Crystalon SAN Tumbler	DX21259000*	RW20	07, 13, 55	48 ea	7.00/0.62
4010	9.5 oz Crystalon SAN Tumbler	43635L	RW30	07, 54	48 ea	7.58/0.53
4012	12 oz Crystalon SAN Tumbler	5212L	RG25-2	07, 54, 64	48 ea	8.88/0.61
4016	16 oz Crystalon SAN Tumbler	DXTT58*	RW20-1	07, 13, 54, 55, 64	48 ea	11.90/0.72
4020	20 oz Crystalon SAN Tumbler	—	RW20-1	07, 13, 54, 64	48 ea	12.50/0.90

NSF Listed products are designated with a Δ

Note: \*The DX Series Disposable Lids listed above are available through the Carlisle | Dinx Catalog



# POLYCARBONATE TUMBLERS

## Crystalon® Polycarbonate Tumblers In RimGlow™ Colors

- Tumblers change hue and intensity with variations in lighting, perspective, and beverage color
- Mix and match colors in brilliant, long-lasting polycarbonate
- Coordinates with Caribbean color dinnerware shown in the Dinnerware section of this catalog
- Dishwasher safe



4035

## Polycarbonate Stackable Tumblers

- Ideal for prisons, schools, and high-volume chains
- Extremely break-resistant polycarbonate extends tumbler life
- Dishwasher safe



## Swirl Polycarbonate Tumblers

- Unique swirl design creates a perfect glass-like tabletop beverage presentation
- Dishwasher safe



## Lafayette® Polycarbonate Tumblers

- Distinctive fluted pattern has the look and style of glass
- Perfect for bar service, room service, or catered events
- Stacking lugs prevent jamming
- Slotted base allows complete draining
- Dishwasher safe



Prod No	Description	Disposable Lid	Glass Rack	Color	Pack	Cs Wt/Cube
<b>Crystalon Polycarbonate RimGlow Tumblers</b>						
4033	12 oz Crystalon PC Tumbler	5212L	RG25-2	09, 14, 22, 52	48 ea	9.20/0.60
4034	16 oz Crystalon PC Tumbler	DXTT58*	RW20-1	07, 09, 14, 22, 52	48 ea	11.90/0.72
4035	20 oz Crystalon PC Tumbler	—	RW20-1	09, 14, 22, 52	48 ea	12.50/0.90
<b>Polycarbonate Stackable Tumblers</b>						
5105-2	5 oz PC Stackable Tumbler	DX1193ST8714*	RW20	07	24 ea	2.50/0.20
5108-2	8 oz PC Stackable Tumbler	—	RG36-1	07	24 ea	3.00/0.25
5109-2	9.5 oz PC Stackable Tumbler	5109L	RW30	07	24 ea	3.55/0.25
5112-2	12.5 oz PC Stackable Tumbler	DXTT50*	RW30-1	07	24 ea	4.25/0.46
5116-2	16.5 oz PC Stackable Tumbler	DX22259000*	RG25-2	07, 10	24 ea	4.85/0.40
5120	20 oz PC Stackable Tumbler	DX30008714*	RW20-2	07	24 ea	6.30/0.48
<b>Swirl Polycarbonate Tumblers</b>						
43662	5 oz Swirl PC Tumbler	—	RG36-1	07	36 ea	4.06/0.23
43663	8 oz Swirl PC Tumbler	DX20029000*	RG36-1	07	36 ea	5.15/0.41
43664	9 oz Swirl PC Tumbler	—	RG25-1	07	36 ea	4.77/0.44
43665	10 oz Swirl PC Tumbler	—	RW30-1	07	36 ea	6.20/0.50
43666	12 oz Swirl PC Tumbler	—	RG25-2	07	36 ea	7.63/0.67
43668	16 oz Swirl PC Tumbler	—	RW20-1	07	36 ea	7.52/0.61
43674	22 oz Swirl PC Tumbler	—	RW20-2	07	36 ea	10.96/0.89
<b>Lafayette Polycarbonate Tumblers</b>						
43633	8 oz Lafayette PC Tumbler	DX20029000*	RG36-1	07	36 ea	5.70/0.30
43635	10 oz Lafayette PC Tumbler	43635L	RW30-1	07	36 ea	5.34/0.38
43636	12 oz Lafayette PC Tumbler	43636L	RG25-2	07	36 ea	7.60/0.38
43637	12 oz Lafayette PC Old Fashion Tumbler	DX21259000*	RW20	07	36 ea	7.10/0.42
43638	16 oz Lafayette PC Tumbler	DX21259000*	RW20-1	07	36 ea	7.59/0.52
43640	22 oz Lafayette PC Tumbler	—	RW20-2	07	36 ea	9.07/0.69

Note: \*The DX Series Disposable Lids listed above are available through the Carlisle | Dinex Catalog



Carlisle's recommended Glass Rack is listed in the product chart

# MUGS & CARAFE

## Lexington™ Polycarbonate Mug

- Heavy-weight mug offers traditional styling in shatterproof polycarbonate
- Crystal clear mug has the look and feel of glass without the replacement
- Recessed drain for easy drying
- Dishwasher safe



43965

## Coffee Mugs

- Rugged chip and crack-resistant plastic to give you long-wearing service
- Diablo and Rustic mugs have double-wall construction to maintain hot temperatures longer, reducing refills
- Diablo II has single-wall construction for money-saving service
- Stackable mug has a clean design and economical price
- All mugs are dishwasher safe



8505

8004

4512

## Color-Coordinated Mugs

- 10 oz Stackable Mug is designed to coordinate with our dinnerware lines
- See the Dinnerware section for a complete listing of coordinated pieces



43052

43058



## The Custom Look

Customized mugs help promote your company or services. See pages 292-294 of the Custom Imprinting Section in the back of this catalog.



## 2 Cup Carafe

- Durable SAN 11 oz capacity carafe is perfect for room service, hospitals, nursing homes, restaurants, and cafeterias
- Ribbed neck and textured finish provides a better grip and greater safety than glass bottles
- BPA free
- Dishwasher safe



7000



Prod No	Description	Disposable Lid	Glass Rack	Color	Pack	Cs Wt/Cube
<b>Lexington Polycarbonate Mug</b>						
43965	16 oz Lexington Mug	43965L	RG9-2	07	12 ea	10.00/0.66
<b>Coffee Mugs</b>						
8004	8 oz, 4.13" Diablo Mug with White Liner	—	RG9-1	01, 02, 05	36 ea	15.66/1.18
8104	8 oz, 4.13" Diablo II Mug	—	RG9-1	01	36 ea	9.86/1.18
8505	8 oz, 4.25" Rustic Mug	—	RG9-1	19	36 ea	18.86/1.18
4512	12 oz, 5.5" Jumbo Soup/Latté Mug	—	RTP	19, 28	24 ea	14.16/1.00
43052	10 oz, 3.25" SAN Stackable Mug	—	RG9-1	02, 03, 09, 14, 22, 42, 52, 71	12 ea	4.00/0.31
43058	10 oz, 3.25" PC Stackable Mug	—	RG9-1	02, 03, 09, 14, 22, 42, 52, 71	12 ea	4.00/0.31
<b>2 Cup Carafe</b>						
7000	11 oz Carafe	DX55-57*	RG16-2	07	36 ea	9.22/1.91

Note: \*The DX Series Disposable Lids listed above are available through the Carlisle | Dinex Catalog



Carlisle's recommended Glass Rack is listed in the product chart

# PITCHERS

## VersaPour® Polycarbonate Pitchers

- Lip design allows for easy pouring with ice from front or either side without splashing
- Sure grip ergonomic handle and thumb grip helps control pouring
- Made of break-resistant polycarbonate for ultimate durability
- Thinner wall provides optimum strength and durability; reduces wait staff's wrist stress
- 5544 Window Pitcher provides a smooth surface for printing your logo; accommodates up to 2.88" wide by 2" tall image
- See pages 292-294 for custom printing information
- NSF Listed; dishwasher safe



VersaPour's specially contoured lip design allows for easy pouring with ice from front or sides without splashing

## Polycarbonate Pitchers

- Ice trap retains ice or beer foam
- Made of break-resistant polycarbonate for ultimate durability
- NSF Listed; dishwasher safe



### Crystalite® Polycarbonate Pitchers

- Tapered lip permits controlled pouring of the beverage and ice
- Secure thumb-hold on handle aids control of pitcher while pouring
- Slot at skirt base deters water collection
- Made of break-resistant polycarbonate for ultimate durability
- NSF Listed; dishwasher safe



5570

5571



5583

5587

### Élan™ Polycarbonate Pitcher

- Thick walls and optic bottom gives these pitchers the look of glass
- Made of break-resistant polycarbonate
- Lid available separately
- Dishwasher safe

### Stainless Steel Pitchers

- The look of silver, with the durability of stainless steel
- 18-8 stainless steel with mirror-polished finish
- Contoured lip to help control flow and prevent drips
- Hollow tubular handle
- Handwashing recommended



Clear(07)



Amber(13)



609270

Prod No	Description	Glass Rack	Color	Pack	Cs Wt/Cube
<b>VersaPour Polycarbonate Pitchers</b>					
5540 Δ	60 oz VersaPour Pitcher	RF	07, 13	6 ea	4.40/0.88
5544 Δ	60 oz VersaPour Window Pitcher	RF	07	6 ea	4.40/1.23
<b>Polycarbonate Pitchers</b>					
5536 Δ	32 oz Polycarbonate Pitcher	RF	07	6 ea	3.65/0.44
5538 Δ	48 oz Polycarbonate Pitcher	RF	07	6 ea	4.43/1.00
<b>Crystalite Polycarbonate Pitchers</b>					
5583 Δ	48 oz Crystalite Pitcher	RF	07	6 ea	6.05/0.99
5587 Δ	60 oz Crystalite Pitcher	RF	07	6 ea	6.94/1.22
<b>Élan Polycarbonate Pitcher &amp; Lid</b>					
5570	58 oz Élan Pitcher	RF	07	6 ea	11.35/1.31
5571	Clear Lid for Élan Pitcher	—	07	6 ea	1.50/0.14
<b>Stainless Steel Pitchers</b>					
609270	2 qt Stainless Steel Bell Pitcher	—	—	1 ea	2.00/0.22
609273	3 qt Stainless Steel Bell Pitcher	—	—	1 ea	3.00/0.38

NSF Listed products are designated with a Δ

# DISPOSABLE LIDS



5812L  
with 5812



1110L  
with 1110



1110L  
with 43648



43636L  
with 4010



5506L  
with 5506



43635L  
with 43635

## Disposable Lids

- Carlisle Disposable Lids are a green solution that saves you money
- Lower your disposable costs when you replace your disposable kids cups with reusable Carlisle Tumblers and Disposable Lids
- Snug fitting lids fit a variety of Carlisle Tumblers and are slotted for use with straws
- Use for room service applications or anywhere you want to avoid spills
- Lids are packed 1,000 per case



In addition to the disposable lids listed here, Carlisle | Dinex offers a large selection of disposable lids for Carlisle and non-Carlisle tumblers. See the Carlisle | Dinex catalog for a complete listing, or contact your local Dinex sales representative for more information.



Translucent(30)

Prod No	Description	Color	Pack	Cs Wt/Cube
<b>Disposable Lids</b>				
5810L	Fits 10 oz Louis Tumbler 5810	30	1 cs	4.05/0.84
5812L	Fits 12 oz Louis Tumbler 5812	30	1 cs	5.00/1.19
5822L	Fits 22 oz Louis Tumbler 5822	30	1 cs	6.12/1.68
5212L	Fits 12 oz Stackable Tumbler 5212, 12 oz Crystalon SAN Tumbler 4012, and 12 oz Crystalon PC Tumbler 4033	30	1 cs	7.42/0.46
5109L	Fits 9.5 oz Stackable PC Tumbler 5109	30	1 cs	3.21/0.91
5506L	Fits 9.5 oz Stackable Tumbler 5506	30	1 cs	3.75/0.84
43635L	Fits 10 oz Lafayette Tumbler 43635 and 9.5 oz Crystalon SAN Tumbler 4010	30	1 cs	3.75/0.84
43636L	Fits 12 oz Lafayette Tumbler 43636	30	1 cs	4.05/0.84
1112L	Fits 12 oz Bistro Tumbler 1112	30	1 cs	3.75/0.84
1110L	Fits 10 oz Bistro Tumbler 1110 and 8 oz Lorraine Tumbler 43648	30	1 cs	4.05/0.84
43965L	Fits 16 oz Lexington Mug	30	1 cs	3.75/1.16
63910L	Fits 10 oz Cambro® Tumbler NT10	30	1 cs	3.75/0.84
63912L	Fits 12 oz Cambro® Tumbler NT12	30	1 cs	7.42/0.46
52412L	Fits 12 oz Cambro® Tumbler LT12	30	1 cs	7.42/0.46

\*Cambro® is a registered trademark of Cambro® Manufacturing Company

\*\*Carlisle is not associated in any way with Cambro® Manufacturing Company



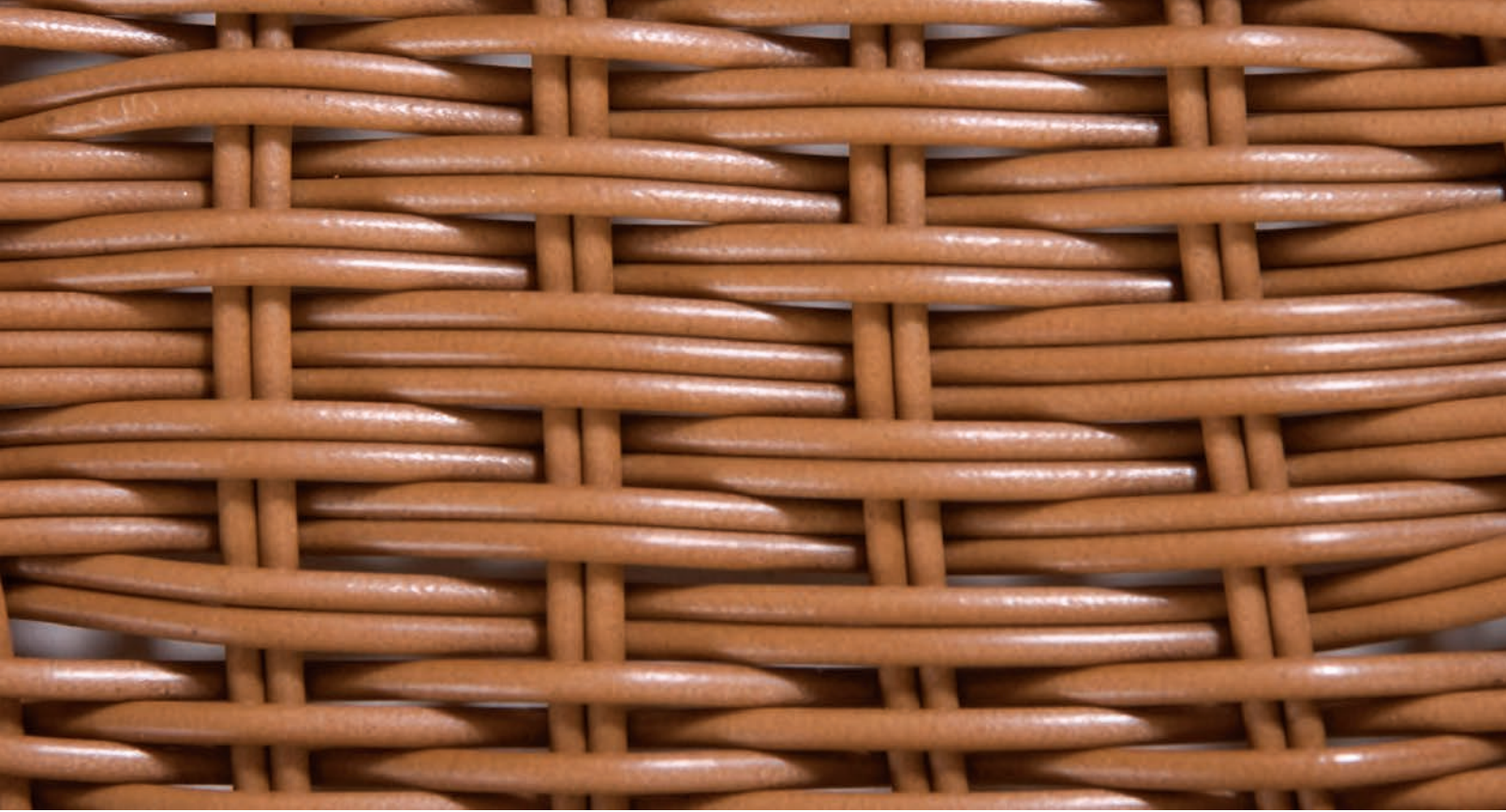

# TABLETOP ACCESSORIES

When your operation demands rugged, practical elegance, Carlisle's tabletop accessories get the job done in style. From ramekins and servers to baskets and beverage service, our full line makes Carlisle the one company you need for all your tabletop accessories.

<b>Product</b>	<b>Page</b>
<b>Baskets</b>	
Basket Server . . . . .	.51
Bread & Bun Basket . . . . .	.51
Munchie Baskets . . . . .	.50
WeaveWear Baskets & Platter . . . . .	.50
Wicker Basket . . . . .	.51
Woven Baskets . . . . .	.50
<b>Booster Seats</b> . . . . .	
Bread & Bun Basket . . . . .	.51
Bud Vases . . . . .	.49
Butter Dish . . . . .	.45
Chopsticks . . . . .	.55
<b>Coffee Service</b>	
Cheese Shaker/Sugar Pourer . . . . .	.48
Creamer/Pitchers . . . . .	.48
Sugar Caddies . . . . .	.48
Dishes, Roll-Top . . . . .	.55
Gravy Boats . . . . .	.48
J-Jars . . . . .	.49
Molcajete Ramekins . . . . .	.46
Number Stands . . . . .	.55
Platters . . . . .	.53
Platters, Steak/Fajita . . . . .	.53

<b>Product</b>	<b>Page</b>
<b>Ramekins</b>	
Carlisle . . . . .	.46
Japanese Style . . . . .	.45
Melamine . . . . .	.44-46
Molcajete . . . . .	.46
Oval . . . . .	.44
SAN . . . . .	.47
Scalloped . . . . .	.45
Square . . . . .	.44
Stainless Steel . . . . .	.46
Straight Sided . . . . .	.44
Salsa Dishes & Bowls . . . . .	.46
<b>Sauce Cups</b>	
Sea Shell . . . . .	.46
Soufflé . . . . .	.46
Stainless Steel . . . . .	.46
<b>Serving Trays</b>	
Melamine . . . . .	.54
Plastic . . . . .	.54
Sugar Caddies . . . . .	.48
Trays, Serving . . . . .	.54
Tortilla Servers . . . . .	.52
Vases . . . . .	.49

# RAMEKINS

## Straight Sided Ramekins

- Melamine ramekins are safe for temperatures up to 212° F
- A modern take on a traditional product
- Use for sauces, condiments and mini desserts
- Ramekins stack for easy storage and space savings
- NSF Listed; dishwasher safe



## Oval Ramekins

- Heavy-weight melamine ramekins are perfect for sauces, condiments, finger foods, mini desserts, etc.
- Oval shape is great for pouring dressings and sauces
- Wide design makes dipping easier
- NSF Listed; dishwasher safe

## Square Melamine Ramekins

- Made of sturdy, break-resistant melamine
- 2 oz square ramekins available in single and double sizes
- Ramekins are stackable and can be used as a set for a variety of dipping sauces, or individually for soy sauce and other condiments
- Safe for temperatures up to 212°F
- NSF Listed; dishwasher safe



### Japanese Style Ramekin

- Made of sturdy, break-resistant melamine
- 2 oz ramekins are styled with an Asian flare
- Heavy-weight design has the look and feel of ceramic or glass
- Ramekins are stackable and can be used for wasabi, ginger, or a variety of dipping sauces
- Safe for temperatures up to 212°F
- NSF Listed; dishwasher safe



### Scalloped Melamine Ramekins

- Made of thick walled, heavy-weight melamine
- Stylish design coordinates with our dinnerware and display pieces
- Serves sauces, butter, salad dressings, salsa, etc.
- NSF Listed; dishwasher safe

### Melamine Butter Dish

- Ideal for small portions of butter, wasabi, or other condiments
- Wide mouth gives the illusion of a larger portion
- Heavy-weight sides have the look and feel of ceramic or glass
- Unique look is perfect for casual dining, upscale, or even pre-portioning in buffet and catering applications
- NSF Listed; dishwasher safe



Prod No	Description	Color	Pack	Cs Wt/Cube
<b>Straight Sided Ramekins</b>				
408 Δ	1.5 oz Straight Sided Ramekin	02, 03, 42	48 ea	7.65/0.32
410 Δ	2 oz Straight Sided Ramekin	02, 03, 42	48 ea	8.49/0.37
412 Δ	3 oz Straight Sided Ramekin	02, 03, 42	48 ea	11.13/0.56
414 Δ	4 oz Straight Sided Ramekin	02, 03, 42	48 ea	11.97/0.64
<b>Oval Ramekins</b>				
S310 Δ	2 oz Oval Ramekin	02, 03, 42, 69	48 ea	1.72/0.19
S312 Δ	3 oz Oval Ramekin	02, 03, 42	48 ea	4.63/0.14
S314 Δ	4 oz Oval Ramekin	02, 03, 42	48 ea	5.29/0.17
<b>Square Melamine Ramekins</b>				
0860 Δ	2 oz Square Ramekin	02, 03	48 ea	4.80/0.09
0862 Δ	Double 2 oz Square Ramekin	02, 03	24 ea	5.06/0.16
<b>Japanese Style Ramekin</b>				
0864 Δ	2 oz Japanese Style Ramekin	02, 03	48 ea	8.16/0.02
<b>Scalloped Ramekins</b>				
43942 Δ	2 oz Scalloped Ramekin	02, 03	48 ea	6.55/0.23
43943 Δ	3 oz Scalloped Ramekin	02, 03	48 ea	8.08/0.31
43944 Δ	4 oz Scalloped Ramekin	02, 03	48 ea	8.18/0.32
<b>Melamine Butter Dish</b>				
0855 Δ	1 oz Melamine Butter Dish	02	48 ea	5.52/0.18

NSF Listed products are designated with a Δ



# RAMEKINS & SAUCE CUPS

## Melamine Ramekins

- Thick walled, heavy-weight melamine serves sauces, butter, salad dressings, salsa, etc.
- NSF Listed; dishwasher safe



## Cash 'N Carry

Selected products also available in a cash 'n carry pack. See page 276.



## Salsa Dishes

- Carlisle salsa dishes are available in a variety of sizes, weights, and materials
- Designed to accommodate dipping large chips or appetizers

## Molcajete Ramekins

- Distinctive footed style and wide mouth design offers a unique alternative to traditional salsa dishes
- NSF Listed

## Deep Salsa Bowl

- Deep salsa bowl has 8 oz capacity, perfect for serving salsa, cheese sauce, soups, and other sauces

## Ramekins & Sauce Cups

- Perfect for individual service of butter, salsa, condiments, sauce
- Made of durable, break-resistant SAN
- 0362, 0843, 0844, 0845, 2500: NSF Listed; dishwasher safe



## Carlisle® Ramekins

- Available in 4 sizes
- NSF Listed

## Sauce Cups

- Choose Sauce or Oyster Cup

## Sea Shell Sauce Cup

- Distinctive shell style

## Soufflé Cups

- Unique design available in two sizes



## Stainless Steel Ramekin & Sauce Cup

- Rust-free, 18-8 stainless provides durable, easy care service
- Dishwasher safe





### SAN Ramekins

- Economical SAN ramekins serve sauces, butter, salad dressings, salsa, etc.
- Stackable design for easier storage
- Dishwasher safe



Prod No	Description	Color	Pack	Cs Wt/Cube
<b>Ramekins</b>				
S277 $\Delta$	1.75 oz Smooth Ramekin	42	48 ea	4.75/0.24
S275 $\Delta$ <b>C</b>	1.5 oz Smooth Ramekin	02, 03, 09, 14, 22, 52, 60	48 ea	5.15/0.26
0852 $\Delta$	2 oz Smooth Ramekin	02, 03, 09, 14, 16, 22, 42, 52, 58, 60, 68, 69, 77	72 ea	10.50/0.35
S280 $\Delta$	3 oz Smooth Ramekin	02, 03, 42, 52, 58, 60, 69	48 ea	8.60/0.35
S285 $\Delta$ <b>C</b>	4 oz Smooth Ramekin	02, 03, 09, 14, 16, 22, 42, 52, 58, 60, 68, 77	48 ea	9.75/0.39
S286 $\Delta$	6 oz Smooth Ramekin	02, 03, 42, 60, 69	48 ea	12.65/0.50
S279 $\Delta$ <b>C</b>	2 oz Fluted Ramekin	02, 03, 09, 42, 60, 69	48 ea	7.00/0.33
S282 $\Delta$ <b>C</b>	3 oz Fluted Ramekin	02, 03, 42, 60, 69	48 ea	8.60/0.35
S287 $\Delta$ <b>C</b>	4 oz Fluted Ramekin	02, 03, 42, 60, 69	48 ea	9.70/0.43
602400	1.5 oz Stainless Steel Classic Ramekin	—	144 ea	6.50/0.40
602500	2.5 oz Stainless Steel Classic Sauce Cup	—	144 ea	8.10/0.38
<b>Salsa Dishes</b>				
43125	5 oz Salsa Dish	60	48 ea	6.14/0.32
4553	8 oz Deep Salsa Bowl	28	36 ea	8.07/0.85
0875 $\Delta$ <b>C</b>	5 oz Salsa Dish	02, 03, 42, 60	48 ea	10.70/0.36
0873 $\Delta$	3 oz Molcajete Ramekin	03	48 ea	8.67/0.32
0878 $\Delta$	8 oz Molcajete Ramekin	03	48 ea	10.15/0.50
<b>Sauce Cups</b>				
0362 $\Delta$	2.5 oz Standard Ramekin	02, 07, 28	48 ea	4.35/0.36
0843 $\Delta$	1 oz Fluted Ramekin	02	48 ea	2.10/0.17
0844 $\Delta$ <b>C</b>	2 oz Fluted Ramekin	02, 07	48 ea	3.05/0.30
0845 $\Delta$ <b>C</b>	4.5 oz Fluted Ramekin	02, 07, 28	48 ea	5.30/0.59
2500 $\Delta$	2.5 oz SAN Sauce Cup	07	72 ea	3.35/0.50
0820	2.75 oz Oyster Sauce Cup	07	144 ea	7.50/1.40
0338	2 oz Sea Shell Sauce Cup	02, 07	48 ea	4.20/0.35
0830	1 oz Soufflé Cup	07	144 ea	5.65/0.58
0831	2.5 oz Soufflé Cup	07	144 ea	12.10/1.29
<b>SAN Ramekins</b>				
43121	1.5 oz Smooth Ramekin	42	48 ea	3.00/0.29
43122	2 oz Smooth Ramekin	03	48 ea	3.50/0.22
43123	3 oz Smooth Ramekin	03, 42	48 ea	4.00/0.24
43133	3 oz Fluted Ramekin	60	48 ea	8.60/0.29
43126	6 oz Smooth Ramekin	03, 42, 60	48 ea	6.41/0.38

NSF Listed products are designated with a  $\Delta$

Cash 'N Carry products are designated with a **C**

# COFFEE SERVICE



## Coffee Service

### Sugar Caddies

- Merchandiser Caddy has pockets for salt and pepper shakers plus sign clip
- NSF Listed; dishwasher safe



### Cash 'N Carry

Selected products also available in a cash 'n carry pack. See page 276.

## Creamer/Pitchers

- Stain-resistant containers can be used for syrup, cream, salad dressings, sauces, etc
- Easy pour, no-drip lip design
- Made of dishwasher safe SAN; safe for temperatures from 0° to 180°F
- 4560: NSF Listed



## Cheese Shaker/Sugar Pourer

- Popular size base is made of durable, break-resistant SAN
- Threaded containers fit standard shaker or pourer caps



## Rhapsody™ Gravy Boats

- Perfectly balanced handle is securely welded to the base to easily pour gravies, sauces, or dressings
- Tapered spout helps prevent dripping
- Made of easy to care for, tarnish-resistant 18-8 stainless steel



### J-Jars

- Durable jars are ideal for condiments of all types: jelly, jam, mustard, sauces, etc.
- Chrome-plated caddy offers beauty and strength
- NSF Listed



### Cash 'N Carry

Selected products also available in a cash 'n carry pack. See page 276.



### Bud Vases

- Let flowers add the finishing touch to any tabletop
- Beautiful break-resistant acrylic with heavy base to prevent messy spills



White(02)



Black(03)



Clear(07)



Lenox  
Brown(28)



Cobalt  
Blue(60)

Prod No	Description	Color	Pack	Cs Wt/Cube
<b>Caddies, Pitchers &amp; Pourers</b>				
4549 $\Delta$	Crystalite Caddy (holds 20 packets)	07	24 ea	4.20/0.36
4550 $\Delta$ <b>C</b>	Standard Caddy (holds 20 packets)	02, 03, 07, 28, 60	24 ea	5.26/0.37
4551 $\Delta$	Merchandiser Caddy (holds 50 packets)	03, 28	24 ea	8.51/0.76
4552 $\Delta$	Three Compartment Caddy (holds 50 packets)	02	24 ea	5.11/0.36
4560 $\Delta$ <b>C</b>	2 oz Syrup Pitcher/Creamer	02	36 ea	4.86/0.32
4563	3 oz Creamer/Pitcher	02	36 ea	6.89/0.48
3312	12 oz Base Only	07	72 ea	12.82/1.28
3316	Base with Pourer Top	07	36 ea	8.24/0.71
3319	Base with Shaker Top	07	36 ea	8.24/0.71
<b>Gravy Boats</b>				
609111	3 oz Gravy Boat	—	24 ea	5.00/0.35
609112	5 oz Gravy Boat	—	12 ea	4.00/0.29
609113	8 oz Gravy Boat	—	10 ea	5.00/0.37
<b>J-Jars</b>				
4571 $\Delta$	8 oz J-Jar only	—	24 ea	4.56/0.50
4572 $\Delta$	J-Jar Lid only	—	24 ea	1.44/0.18
4573	Caddy with 3 J-Jars & Lids	—	1 ea	1.75/0.27
4575 $\Delta$ <b>C</b>	8 oz J-Jar with Lid	—	24 ea	5.65/0.67
<b>Bud Vases</b>				
4650	4" Acrylic Bud Vase	—	12 ea	6.10/0.32
4651	6" Acrylic Bud Vase	—	12 ea	6.10/0.32

NSF Listed products are designated with a  $\Delta$

Cash 'N Carry products are designated with a **C**

# SERVING BASKETS



## Woven Baskets

- Handmade natural beauty combined with easy care
- Resistant to mold and mildew
- Microwave safe
- Dishwasher safe

## Munchie Baskets™

- Excellent for serving a deli sandwich or a specialty appetizer
- Stackable and dishwasher safe
- The only basket in the industry that can be custom imprinted; see pages 292-294 for imprinting information



## WeaveWear™ Baskets & Platter

- For serving chips, fries, sandwiches, finger foods, or kids' meals
- Wicker weave pattern exterior with smooth, easy to clean interior
- Safe alternative to wicker and plastic coated wire
- Made of durable FDA grade polypropylene
- Wide diameter and raised bottom design on 6527 creates a unique presentation for your signature sandwich, appetizer, or specialty item
- 6527 has a shallow serving area for portion control
- Dishwasher safe



### Wicker Basket

- Elegant baskets for serving chips, fries, sandwiches, finger foods, or kids' meals
- Design features a detailed wicker weave patterned exterior
- Smooth, easy-to-clean interior
- Made of durable, scratch-resistant polycarbonate



WB965



0333

### Bread & Bun Basket

- Extremely economical basket is great for all types of food such as sandwiches, fries, ribs, chips, or breads

### Basket Server

- Break-resistant SAN baskets can be used for holding tall items like bread sticks or can be used as an ice bucket for table or room service
- Safe for use in temperatures from 0° to 180°F
- Dishwasher safe



356



Brown(01)



Black(03)



Red(05)



Oatmeal(06)



Clear(07)



Green(09)



Caramel(25)



Light Brown(31)



Straw(67)

Prod No	Description	Color	Pack	Cs Wt/Cube
<b>Woven Baskets</b>				
6550	9" x 6.25" Small Oval Basket	03, 06, 25	6 ea	3.00/0.24
6551	11.75" x 7.75" Medium Oval Basket	03, 06, 25	6 ea	4.00/0.45
6552	11.5" x 8.5" Rectangle Oval Basket	03, 06, 25	6 ea	4.00/0.39
6553	9" Small Round Basket	03, 06, 25	6 ea	3.00/0.58
6554	11" Medium Round Basket	03, 06, 25	6 ea	4.00/0.74
<b>Munchie Baskets</b>				
44030	10.38" x 8" Munchie Basket	03, 05	24 ea	5.30/0.39
44031	7.38" x 5.38" Munchie Basket	03, 05	12 ea	5.00/0.39
<b>WeaveWear Baskets &amp; Platter</b>				
6504	9" x 6.25" Oval WeaveWear Basket	01, 03, 05, 09, 67	12 ea	3.90/0.37
6524	9" Round WeaveWear Basket	01, 03, 05, 09, 67	12 ea	5.30/0.40
6526	12" Round WeaveWear Basket	01, 03, 05, 09, 67	12 ea	8.00/0.79
6527	10.38" Round WeaveWear Platter	03, 31	12 ea	7.65/1.04
<b>Wicker Basket</b>				
WB965	9.44" x 6.63" Oval Basket	07	6 ea	3.30/0.44
<b>Bread &amp; Bun Basket</b>				
0333	9.25" x 6" Oval Basket	03, 05	36 ea	4.41/0.72
<b>Basket Server</b>				
356	6.5" Basket, 3 qt	07	6 ea	7.10/0.99

# TORTILLA SERVERS

## Tortilla Servers

- Unique Aztec design works well in any traditional Mexican or Tex-Mex restaurant
- 8" and 12" servers available in a lift off lid model
- 7" server available with hinged lid for easy one handed access
- Thick walled polypropylene material helps keep tortillas warm for table service
- Microwaveable, safe for temperatures up to 190° F
- Servers are stackable
- NSF Listed; dishwasher safe



## Tortilla Servers

- Interlocking base/lid design allows for stacking several tortilla servers at one time
- Lid has easy-grip, recessed handle
- Durable polycarbonate tortilla servers withstand temperatures up to 212°F
- Polypropylene servers are easy-clean, long-lasting, and economical; withstand temperatures up to 190°F
- NSF Listed; dishwasher safe

US Patent No. D-331351





ARR113

### Oval Platters in Caribbean Colors

- Rimmed edge design easily substitutes as a tray – holding soup and salad bowls, sandwiches and side dishes
- Six stacking lugs keep large stacks of platters from wedging or leaning
- Made of heavy-duty, break-resistant melamine
- Safe for temperatures up to 212° F
- Coordinates with our Caribbean Color Dinnerware shown on pages 14, 28, 46 & 47
- NSF Listed; dishwasher safe

### Steak/Fajita Platters

- Heavy gauge aluminum heats quickly and holds temperature longer
- Perfect for steaks, seafood, or fajitas
- Easy care mirror-polished platter
- Dishwasher safe



60900

60901

60902

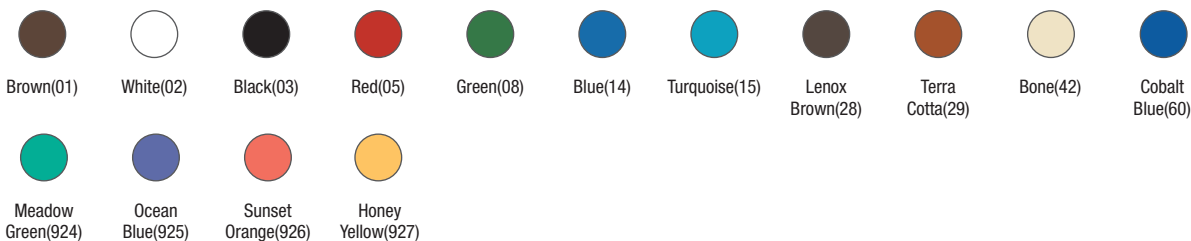

Prod No	Description	Color	Pack	Cs Wt/Cube
<b>Aztec Tortilla Servers &amp; Lids</b>				
0710 Δ	7" Hinged Tortilla Server	03, 05, 08, 14, 29	12 ea	12.26/1.01
0713 Δ	8" Lift Off Tortilla Server	03, 05, 08, 14, 29	12 ea	21.00/2.47
0717 Δ	12" Lift Off Tortilla Server	03, 05, 08, 14, 29	6 ea	21.00/2.12
0700 Δ	7" Hinged Replacement Lid	03, 05, 08, 14, 29	12 ea	3.50/0.27
0703 Δ	8" Replacement Lid	03, 05, 08, 14, 29	12 ea	7.00/0.60
0707 Δ	12" Replacement Lid	03, 05, 08, 14, 29	6 ea	8.00/0.76
<b>Interlocking Tortilla Servers &amp; Lids</b>				
0470 Δ	7.5" PC Tortilla Server	01, 02, 03, 05, 15, 60	24 ea	16.22/1.80
0475 Δ	7.5" PPY Tortilla Server	03, 05, 28, 42	24 ea	12.31/1.80
0471	PC Replacement Lid	01, 02, 03, 05, 15, 60	24 ea	7.60/0.67
0476	PPY Replacement Lid	03, 05, 28, 42	24 ea	6.26/0.65
<b>Oval Platter</b>				
ARR113 Δ	14.75" x 10.5" Oval Platter	924, 925, 926, 927	12 ea	15.00/0.89
<b>Steak/Fajita Platters</b>				
60900	10.25" Steak/Fajita Platter	—	12 ea	10.00/0.19
60901	11.5" Steak/Fajita Platter	—	12 ea	13.00/0.24
60902	12.5" Steak/Fajita Platter	—	12 ea	16.00/0.28

NSF Listed products are designated with a Δ



# SERVING TRAYS & ACCESSORIES



## Serving Trays

- Serving Trays are perfect for bar service or individual meals including salads, sandwiches, or burgers
- Perfect size for iced seafood platters

## Melamine Trays

- 44530, 44532 and 1300 are made of heavy-duty, break-resistant melamine
- 44530, 44532 offer a unique Aztec rim design for added style
- Smaller 7.5" size (44530) can be used as a small plate for appetizers or side dishes
- NSF Listed; dishwasher safe

## Plastic Trays

- A modern twist on an old stand by, our Oval Tray is a great alternative to traditional fast-food trays
- Securely holds soup bowls, sandwiches, and salad plates
- Made of a break-resistant polypropylene and available in both contemporary solids and translucent colors
- Handwashing recommended





### Allegro™ Number Stands

- Use taller card holders to identify banquet seating or reserved tables and shorter holders for place cards or on buffet lines
- Heavy-weight base prevents accidental tipping
- 18-10 mirror polish finish



### Roll-Top Covered Dishes

- Multi-purpose roll-top dishes are perfect for serving sugar, candies, sauces or dressings
- High-polish 18-8 stainless steel
- Handwashing recommended

### Chopsticks

- Chopsticks are smooth, durable, and reusable; won't splinter like traditional bamboo
- 10.63" length
- Conveniently packed 6 pairs per pack/12 packs per case



Prod No	Description	Color	Pack	Cs Wt/Cube
<b>Serving Trays</b>				
44530 $\Delta$	7.5" Round Melamine Serving Tray	02, 03	12 ea	6.12/0.25
44532 $\Delta$	11.5" Round Melamine Serving Tray	03	12 ea	12.19/0.61
1300 $\Delta$	13" x 1.5" Melamine Serving Tray	01, 02, 60	12 ea	13.50/1.01
<b>Oval Platter</b>				
6510	13" x 15" Oval PPY Platter	22, 24, 30, 48, 60, 69	12 ea	9.04/0.56
<b>Number Stands</b>				
609179	4" Allegro Number Stand	—	6 ea	1.50/0.06
609183	8" Allegro Number Stand	—	6 ea	3.00/0.17
609184	12" Allegro Number Stand	—	6 ea	3.00/0.23
609185	16" Allegro Number Stand	—	6 ea	5.00/0.46
<b>Roll-Top Covered Dishes</b>				
609131	10 oz Roll-Top Covered Dish	—	12 ea	5.80/0.67
609132	14 oz Roll-Top Covered Dish	—	12 ea	9.55/1.53
609133	30 oz Roll-Top Covered Dish	—	1 ea	1.42/0.24
<b>Chopsticks</b>				
0620	Chopsticks, 10.63"	87	12 st	4.38/0.06

NSF Listed products are designated with a  $\Delta$

# ACCESSORIES

## Dual Booster Seats

- Two-sided seat offers a choice of heights
- Extra-strong, one-piece molded design with wide square base for better stability
- Anti-skid pads on both sides prevent sliding

## Booster Seat With Safety Strap

- Strap secures to chair to increase child safety
- Snap clasp and adjustable strap for use behind chair back or under seat

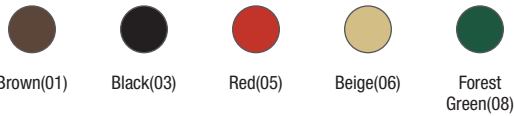

Prod No	Description	Color	Pack	Cs Wt/Cube
<b>Dual Booster Seat</b>				
7110	Booster Seat	01, 03, 05, 06, 08	4 ea	16.50/3.99
<b>Booster Seat with Safety Strap</b>				
7111-4	Booster Seat with Safety Strap	01, 03, 05, 06, 08	4 ea	16.50/3.95
<b>Replacement strap</b>				
7112	Replacement Strap	03	12 ea	2.00/0.43

Note: 7110, 7111-4 can ship UPS/FedEx Ground at oversize cost

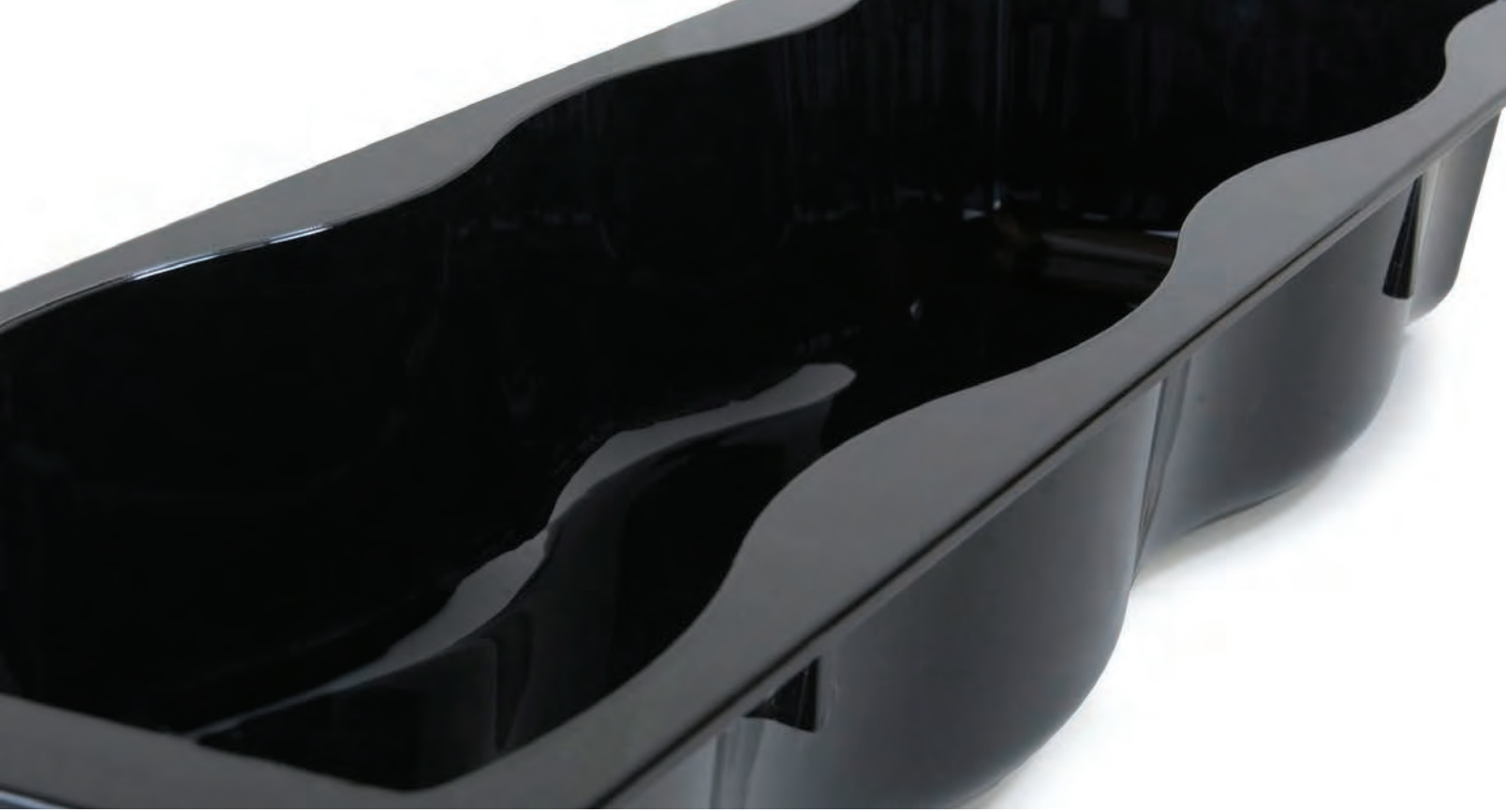

# DISPLAYWARE

Day in and day out Carlisle can help make your deli service both easier and have style. Our break-resistant stylish bowls, aesthetically pleasing Modular Displayware, crocks and platters give you the variety you demand while displaying your foods in a way that makes them look their very best.

<b>Product</b>	<b>Page</b>
Acrylic Pebbled Bowls . . . . .	.76
Allegro & Maestro Display Bowls . . . . .	.79
Aluminum Displayware . . . . .	.78
Balsam Displayware . . . . .	.58
Balti Dishes . . . . .	.78
Bell Bowls . . . . .	.74
Buffet Clam Shells . . . . .	.75
Cake Covers & Tray . . . . .	.80
Corinthian Crocks & Platter . . . . .	.69
Decorated Palette Designer Displayware . . . . .	.64
Deliware Rectangular Crocks . . . . .	.73
Designer Displayware . . . . .	.68
Display Covers (Cover Only) . . . . .	.80
Double-Wall Insulation Maintains Serving Temps . . . . .	.77
Double-Wall Stainless Steel Displayware . . . . .	.77
Epicure Displayware & Coordinating Pieces . . . . .	.66
Flared Square Bowls . . . . .	.59
Leaf Bowls . . . . .	.75
Melamine Salad Bowl . . . . .	.67
Modular Displayware . . . . .	.72

<b>Product</b>	<b>Page</b>
Octagonal Crocks & Platter . . . . .	.71
Octagon Bowls . . . . .	.70
Orchid Deli Bowls . . . . .	.70
Palette Designer Displayware . . . . .	.62
Palette Displayware Covers . . . . .	.63
Petal Mist Plates, Bowls & Trays . . . . .	.74
Plate Stands . . . . .	.68
Rave Displayware . . . . .	.60
Rectangular Deli Crocks & Platter . . . . .	.73
Rimmed Melamine Displayware . . . . .	.66
Round Polycarbonate Pebbled Bowls . . . . .	.76
Scalloped DeliWare & Inset . . . . .	.67
Scalloped Platters . . . . .	.60
Scoop Bowl . . . . .	.69
Square Display Dishes . . . . .	.78
Stack Bowls . . . . .	.74
Step Risers . . . . .	.80
Terra Displayware . . . . .	.61
Tulip Deli Crocks & Platter . . . . .	.70

# MELAMINE DISPLAYWARE

## Balsam™ Displayware

- Clean lines and simple shapes make Balsam Displayware ideal for environments where prepared food is displayed in front of the customer
- One of the most environmentally friendly commercial grade melamines available in the market
- Made from 50% sustainable natural resources versus 20% in standard melamine
- Contains a material that will begin to biodegrade in 90 days in a compostable environment
- Withstands the rigors of commercial foodservice dishwasher use
- Maintains its appearance after one year of dishwasher testing
- Durable melamine is stain, scratch and break-resistant, making it ideal for any foodservice operation
- Safe for temperatures up to 212° F
- NSF Listed; dishwasher safe





## Flared Square Bowls

- Large display bowls coordinate with many other Carlisle pieces
- High quality, heavy-weight melamine
- Safe for temperatures up to 212°F
- NSF Listed; dishwasher safe



33362



33364



33360



White(02)



Black(03)



Bavarian  
Cream(37)

Prod No	Description	Color	Pack	Cs Wt/Cube
<b>Balsam Displayware</b>				
55520 $\Delta$	1" Deep Full Size Pan	37	6 ea	17.89/0.67
55522 $\Delta$	2.5" Deep Full Size Pan	37	6 ea	22.88/1.77
55524 $\Delta$	4" Deep Full Size Pan	37	6 ea	27.63/2.83
55526 $\Delta$	1" Deep Half Long Size Pan	37	6 ea	9.97/0.43
55528 $\Delta$	2.5" Deep Half Long Size Pan	37	6 ea	13.64/1.02
55530 $\Delta$	4" Deep Half Long Size Pan	37	6 ea	17.67/1.34
55532 $\Delta$	1" Deep Half Size Pan	37	6 ea	9.71/0.39
55534 $\Delta$	2.5" Deep Half Size Pan	37	6 ea	12.87/0.93
55536 $\Delta$	4" Deep Half Size Pan	37	6 ea	16.15/1.38
55538 $\Delta$	1" Deep Third Size Pan	37	6 ea	6.97/0.25
55540 $\Delta$	2.5" Deep Third Size Pan	37	6 ea	9.55/0.59
55542 $\Delta$	4" Deep Third Size Pan	37	6 ea	12.25/0.85
55544 $\Delta$	26 oz Angled Bowl	37	6 ea	5.35/0.40
55546 $\Delta$	3 qt Angled Bowl	37	6 ea	9.48/1.16
55550 $\Delta$	26 oz Square Bowl	37	6 ea	4.90/0.08
<b>Flared Square Bowls</b>				
33360 $\Delta$	5 qt, 11.75" Small Flared Bowl	02, 03	4 ea	8.64/0.75
33362 $\Delta$	8 qt, 13.75" Medium Flared Bowl	02, 03	4 ea	11.53/1.06
33364 $\Delta$	15.5 qt, 16.88" Large Flared Bowl	02, 03	4 ea	15.36/1.47

NSF Listed products are designated with a  $\Delta$

# MELAMINE DISPLAYWARE



## Rave® Displayware

- Versatile, contemporary design in a wide range of shapes
- Use for setting up buffets, catered events, deli displays or tabletop arrangements
- Made of heavy-weight, break-resistant melamine
- Offers the look and feel of china without the replacement cost
- Bowls lock into pedestal for secure serving
- Skid-resistant feet
- Safe for temperatures up to 212°F
- Dishwasher safe



## Scalloped Platters

- Oversized platters for display, deli and tabletop presentation
- Attractive scalloped design coordinates with many other Carlisle pieces
- High quality, heavy-weight melamine
- Safe for temperatures up to 212°F
- NSF Listed; dishwasher safe



## Terra® Displayware

- Organic design blends into a variety of settings and offers an exceptional presentation value for buffets or display cases
- Unique textured platters add depth and style to any display
- High quality, heavy-weight melamine
- Safe for temperatures up to 212°F
- NSF Listed; dishwasher safe



White(02)

Black(03)

Prod No	Description	Color	Pack	Cs Wt/Cube
<b>Rave Displayware</b>				
33310	7" Rave Serving Bowl	02, 03	6 ea	9.52/0.59
33312	10" Rave Serving Bowl	02, 03	6 ea	15.60/0.97
33314	12" Rave Salad Bowl	02, 03	6 ea	16.21/1.09
33316	13" Rave Starburst Bowl	02, 03	6 ea	12.10/1.61
33318	15" Rave Bowl with Rim	02, 03	6 ea	17.32/1.61
33320	10" Rave Rectangular Platter	02, 03	6 ea	3.77/0.31
33322	16" Rave Rectangular Platter	02, 03	6 ea	8.79/0.26
33324	23" Rave Rectangular Platter	02, 03	6 ea	12.96/0.47
33326	16" Rave Trapezoid Platter	02, 03	6 ea	10.31/0.48
33302	4" Rave Pedestal	02, 03	12 ea	6.94/0.93
<b>Scalloped Platters</b>				
7924 $\Delta$	14.5" Square Small Scalloped Tray	02, 03	4 ea	11.53/0.46
7926 $\Delta$	16.81" Square Medium Scalloped Tray	02, 03	4 ea	14.81/0.74
7928 $\Delta$	18.81" Square Large Scalloped Tray	02, 03	4 ea	18.37/0.83
7944 $\Delta$	19.5" x 13" Rectangular Small Scalloped Tray	02, 03	4 ea	12.43/0.58
7946 $\Delta$	22.5" x 14.5" Rectangular Medium Scalloped Tray	02, 03	4 ea	16.10/0.72
7948 $\Delta$	24.5" x 18.5" Rectangular Large Scalloped Tray	02, 03	4 ea	21.07/1.04
<b>Terra Displayware</b>				
44514 $\Delta$	14" Round Textured Platter	02, 03	12 ea	22.22/0.87
44518 $\Delta$	18" Round Textured Platter	02, 03	12 ea	40.70/2.02
44520 $\Delta$	13.5" x 9.25" Rectangular Textured Platter	02, 03	4 ea	6.41/0.47
44522 $\Delta$	15.5" x 11" Rectangular Textured Platter	02, 03	4 ea	8.80/0.64
44524 $\Delta$	18" x 12.5" Rectangular Textured Platter	02, 03	4 ea	12.75/0.84

NSF Listed products are designated with a  $\Delta$

# MELAMINE DISPLAYWARE

## Palette Designer Displayware®

All melamine shown on these facing pages offer the following features:

- Palette Designer Displayware is lighter weight than comparable ceramic or enamel pieces
- Combine with decorated Palette pieces for attention getting displays in the deli case or buffet line
- Break-resistant construction reduces replacement costs
- High quality, heavy-weight melamine
- Safe for temperatures up to 212°F
- NSF Listed; dishwasher safe

### Wide Rim

- Classic wide rim styling in a variety of shapes looks great with almost any decor, menu trend, or deli landscape
- Use with displayware covers shown on the facing page



44418



44410



44402



44400



44416

## Palette Designer Displayware®

### Food Pans

- Mix with Palette shapes and decorated pieces shown pages 64-65 for unique displays
- 2.5" and 4" deep pans can be turned over and used as display stands
- Combine with display covers shown on the facing page to create an attractive merchandising display
- NSF Listed; dishwasher safe



44434

44430

44432

44462

44460

44420



## Palette Displayware Covers

- Designed to work with selected pieces of our Palette Displayware
- Clear polycarbonate covers are highly heat- and break-resistant
- Allows you to safely protect and transport dishes prepped in advance
- Stack for compact storage
- Dishwasher safe



Prod No	Description	Cover	Color	Pack	Cs Wt/Cube
<b>Palette Designer Displayware</b>					
43024 $\Delta$	12" Wide Rim Round Plate	1994*	02	12 ea	18.10/0.54
44400 $\Delta$	12" Wide Rim Square Plate	44400C	02, 03	4 ea	7.69/0.29
44402 $\Delta$	14" Wide Rim Square Bowl	44402C	02, 03	4 ea	12.00/0.68
44404 $\Delta$	15" Wide Rim Round Platter	44404C	02	4 ea	9.28/0.39
44406 $\Delta$	19" Wide Rim Round Platter	—	02, 03	4 ea	14.63/0.81
44410 $\Delta$	17" X 13" Wide Rim Oval Platter	44410C	02, 03	4 ea	9.51/0.46
44412 $\Delta$	21" X 15" Wide Rim Oval Platter	44412C	02, 03	4 ea	13.63/0.69
44414 $\Delta$	14" X 10" Wide Rim Rectangle Platter	44414C	02, 03	4 ea	7.53/0.22
44416 $\Delta$	17" X 13" Wide Rim Rectangle Platter	44416C	02, 03	4 ea	11.63/0.44
44418 $\Delta$	22" Wide Rim Salmon Platter	44418C	02, 03	4 ea	7.70/0.34
<b>Palette Designer Displayware Food Pans</b>					
44420 $\Delta$	1" D Full Size Food Pan	44422C	02, 03, 42	6 ea	22.00/0.68
44422 $\Delta$	2.5" D Full Size Food Pan	44422C	02, 03	6 ea	25.30/1.01
44430 $\Delta$	1" D Half Size Food Pan	44432C	02, 03	6 ea	10.78/0.34
44432 $\Delta$	2.5" D Half Size Food Pan	44432C	02, 03, 42	6 ea	12.61/0.55
44434 $\Delta$	4" D Half Size Food Pan	44432C	02, 03	6 ea	15.60/0.73
44440 $\Delta$	1" D Half Size Long Food Pan	—	02, 03	6 ea	11.20/0.33
44460 $\Delta$	1" D Third Size Food Pan	44462C	02, 03	6 ea	7.70/0.22
44462 $\Delta$	2.5" D Third Size Food Pan	44462C	02, 03	6 ea	10.40/0.60
<b>Palette Designer Displayware Covers</b>					
44400C	Cover for 12" Wide Rim Square Plate	—	07	12 ea	12.50/0.29
44402C	Cover for 14" Wide Rim Square Platter	—	07	12 ea	6.00/3.19
44404C	Cover for 15" Wide Rim Round Platter	—	07	12 ea	15.40/1.42
44410C	Cover for 17" x 13" Wide Rim Oval Platter	—	07	12 ea	15.40/1.42
44412C	Cover for 21" x 15" Wide Rim Oval Platter	—	07	12 ea	20.50/2.02
44414C	Cover for 14" x 10" Wide Rim Rectangle Platter	—	07	12 ea	7.51/1.71
44416C	Cover for 17" x 13" Wide Rim Rectangle Platter	—	07	12 ea	17.75/1.42
44418C	Cover for 22" Wide Rim Salmon Platter	—	07	12 ea	14.50/1.14
44422C	Cover for Full Size Food Pan	—	07	12 ea	18.48/1.72
44432C	Cover for Half Size Food Pan	—	07	12 ea	12.00/1.47
44462C	Cover for Third Size Food Pan	—	07	12 ea	7.51/0.77

NSF Listed products are designated with a  $\Delta$

\*1994 Plate Cover can be found in the Dinnerware section of this catalog

# DISPLAYWARE

## Decorated Palette Designer Displayware®

- Carlisle offers seven beautiful patterns to compliment our Palette Designer Displayware line
- Designer patterns coordinate with many of our Palette solid colors and are a smart way to change the look of your display with just a few new decorated pieces
- 12" Durus® Dinner Plates are available in these decorated patterns and coordinate with our Durus Melamine Dinnerware shown on pages 6-9
- Lighter weight than comparable ceramic or enamel pieces
- Break-resistant construction reduces replacement costs
- High quality, heavy-weight melamine
- Safe for temperatures up to 212°F
- NSF Listed; dishwasher safe



Shown with 7932, 7934  
Scalloped DeliWare

44417

43025

44405

44403

44405

43025



44417

44411

### Black Waves (shown above)

A modern presentation designed to enhance your favorite foods. Palette Black Waves pattern mixes beautifully with Venetian Tan, Black & White pieces. (Black Waves is paired above with the Scalloped DeliWare shown on page 67)

### Tan Waves (shown left)

The Tan Waves offers a neutral color presentation that lets your food display be the focal point. Tan Waves compliments the Venetian Tan and White pieces.

### Fresco (shown right)

A fresh look with bold colors to showcase all types of dishes. Palette's Fresco pattern is complimented by our Roma Red and Bone pieces.



44405

44417

43025

44411



**Mediterranean Tile (shown left)**

A classic tile pattern created in beautiful Mediterranean colors for alluring presentations. The Mediterranean Tile pattern mixes beautifully with our Roma Red, Napoli Plum, Firenze Green, Venetian Tan and Bone pieces.

**Spanish Tile (shown right)**

Inspired by the warmth and elegance of Spanish Colonial, this dramatic displayware will help you create equally elegant and inspired tablesettings. The Spanish Tile pattern can be accented with our Sunset Orange, Honey Yellow and White dinnerware, Crystalon™ RimGlow™ Tumblers, Handled Soup Bowl & More!



**Himalayan (shown left)**

A dramatic setting for the exciting flavors, colors, and textures of your most popular dishes. Palette's Himalayan pattern is complimented by our Venetian Tan, Black and White pieces.



**Modern Squares (shown right)**

A fresh look with bold colors to showcase your tablesetting with a touch of retro chic. The Modern Squares pattern mixes beautifully with our Black, White and Venetian Tan pieces.



Fresco(916)



Spanish Tile(917)



Mediterranean Tile(918)



Modern Squares(919)



Himalayan (920)



Black Waves(921)



Tan Waves(922)

Prod No	Description	Color	Pack	Cs Wt/Cube
<b>Decorated Palette Designer Displayware</b>				
43025 $\Delta$	12" Wide Rimmed Durus Plate	916, 917, 918, 919, 920, 921, 922	12 ea	13.50/0.53
44403 $\Delta$	14" Palette Displayware Square Bowl	916, 917, 918, 919, 920, 921, 922	4 ea	9.28/0.39
44405 $\Delta$	15" Palette Displayware Round Platter	916, 917, 918, 919, 920, 921, 922	4 ea	9.28/0.39
44411 $\Delta$	17" x 13" Palette Displayware Oval Platter	916, 917, 918, 919, 920, 921, 922	4 ea	13.63/0.69
44417 $\Delta$	17" x 13" Palette Displayware Rectangular Platter	916, 917, 918, 919, 920, 921, 922	4 ea	11.63/0.44

NSF Listed products are designated with a  $\Delta$



# MELAMINE DISPLAYWARE

## Epicure® Displayware & Coordinating Pieces

- European coupe shape design offers larger serving area
- Coordinates with Epicure Dinnerware shown on page 19
- Stain and scratch-resistant finish
- Made of dependable, impact-resistant melamine
- Safe for temperatures up to 212°F
- NSF Listed; dishwasher safe



43830  
43832  
43834



5933

43807  
43809



43738

43739

ARR240

43842

43737

## Rimmed Melamine Displayware

- Rimmed style displayware in a variety of shapes
- Stain and scratch-resistant finish
- Made of dependable, impact-resistant melamine
- Safe for temperatures up to 212°F
- NSF Listed; dishwasher safe



ARR113



43745

43772

43840

ARR112

ARR120





### Melamine Salad Bowl

- Made of dependable, impact-resistant melamine
- Safe for temperatures up to 212°F
- NSF Listed; dishwasher safe

### Scalloped DeliWare® & Inset

- Low-profile reduces food waste without sacrificing presentation
- 5.5" Square Scalloped Dish is designed to use alone or as an inset in the 18" x 7" Scalloped Platter (7932)
- Use the combination of our inset and platter for displaying foods with toppings or sauces
- Durable melamine material
- NSF Listed; dishwasher safe



White(02)



Black(03)



Tan(25)



Meadow Green(924)



Ocean Blue(925)



Sunset Orange (926)



Honey Yellow(927)

Prod No	Description	Color	Pack	Cs Wt/Cube
<b>Epicure Displayware</b>				
43807 $\Delta$	14" Round Epicure Display Platter	02, 03	12 ea	16.94/0.84
43809 $\Delta$	16" Round Epicure Display Platter	02, 03	12 ea	22.65/1.20
43830 $\Delta$	16" Oval Epicure Display Platter	02	12 ea	16.94/0.83
43832 $\Delta$	18" Oval Epicure Display Platter	02, 03	12 ea	19.58/1.07
43834 $\Delta$	20" Oval Epicure Display Platter	02, 03	12 ea	23.54/1.37
<b>Coordinating Melamine Pieces</b>				
ARR240 $\Delta$	46 oz, 9" Round Open Vegetable Bowl	02	12 ea	8.40/0.51
5933 $\Delta$	32 oz, 8.25" Round Bowl	02	24	17.75/1.28
43737 $\Delta$	24 oz, 7.38" Footed Serving Bowl	02, 03	12 ea	5.00/0.35
43738 $\Delta$	36 oz, 8.63" Footed Serving Bowl	02	12 ea	7.00/0.53
43739 $\Delta$	57 oz, 9.25" Footed Serving Bowl	02	12 ea	10.00/0.77
43842 $\Delta$	14" x 10" Oblong Platter	02, 03	12 ea	11.00/0.48
<b>Rimmed Melamine Displayware</b>				
ARR113 $\Delta$	14.75" x 10.5" Oval Platter	924, 925, 926, 927	12 ea	15.00/0.89
ARR112 $\Delta$	14.75" x 10.5" Oval Platter	02	12 ea	15.00/0.89
ARR120 $\Delta$	12" x 8.5" Oval Platter	02, 25	12 ea	7.10/0.42
43745 $\Delta$	28 oz, 10" x 7.5" Baker/Server	02, 25	12 ea	7.30/0.43
43840 $\Delta$	21" x 15" Catering Platter	02	6 ea	11.75/1.10
43772 $\Delta$	15.5" x 10.5" Oblong Platter	02	12 ea	13.30/0.47
<b>Melamine Salad Bowls</b>				
1000B $\Delta$	1.9 qt, 10" Bowl	03	6 ea	7.10/0.45
1250B $\Delta$	3.7 qt, 12" Bowl	03	6 ea	10.20/0.71
<b>Scalloped DeliWare &amp; Inset</b>				
7930 $\Delta$	14" x 10" Scalloped Baker	03	4 ea	6.95/0.44
7932 $\Delta$	18" x 7" Scalloped Platter	03	4 ea	6.95/0.33
7934 $\Delta$	5.5" Square Scalloped Dish/Inset	03	48 ea	22.44/0.46

NSF Listed products are designated with a  $\Delta$

# DISPLAYWARE

## Designer Displayware®

- Heavy china/ceramic feel and look without the breakage
- Perfect for salads and entrees in family style dining, banquets, buffets, or deli display cases
- Select pieces available in unique two-tone Mosaic colors
- FDA approved material
- Safe for temperatures up to 212°F
- NSF Listed; dishwasher safe



7913



7916  
7918



8910



8920



Colors shown top down:  
Café Blue, White, Black,  
Meadow Green, Terra Cotta



Mosaic Colors shown top  
down: Red/Black, Cobalt/  
White, Terra Cotta/Black

## Plate Stands

- High quality, heavy-weight melamine
- Two height choices add dimension to deli cases or buffets
- Use with a variety of plates and platters including 43024, 44404, and 44406
- NSF Listed; dishwasher safe



7901

7900



### Scoop Bowl

- 4 qt bowls are perfect for buffets or salad bar
- Durable SAN plastic is resistant to food oils and acids
- For use in temperatures from 0° to 180°
- Dishwasher safe

### Corinthian® Crocks & Platter

- A distinctive look for supermarket/deli cases and displays
- Break-resistant ABS material resists food acids and oils
- Stack for easy storage
- Safe for temperatures up to 180°F
- Dishwasher safe



White(02)

Black(03)

Red(05)

Meadow Green(09)

Ocean Blue(14)

Terra Cotta(29)

Café Blue(35)

Cobalt/White(403)

Red/Black(404)

Terra Cotta/Black(406)

Prod No	Description	Color	Pack	Cs Wt/Cube
<b>Designer Displayware</b>				
7910 $\Delta$	5 lb, 10.5" Designer Pasta Bowl	02, 03	4 ea	5.45/0.46
7913 $\Delta$	10 lb, 13" Designer Pasta Bowl	02, 03	4 ea	9.45/0.83
7914 $\Delta$	2 qt, 14" x 10" Oval Designer Platter	02, 03, 29	4 ea	6.30/0.42
7916 $\Delta$	3 qt, 16" x 12" Oval Designer Platter	02, 03, 09, 29, 35	4 ea	8.20/0.63
7918 $\Delta$	4 qt, 19" x 13.75" Oval Designer Platter	02, 03, 14, 29	4 ea	12.25/0.95
7919 $\Delta$	2.9 qt, 9" x 12" Designer Baker	02, 03, 05, 09, 35	4 ea	7.30/0.33
7920 $\Delta$	4 qt, 10" x 14" Designer Baker	02, 03, 05, 09, 14, 35	4 ea	8.10/0.62
<b>Mosaic Designer Displayware</b>				
8910 $\Delta$	5 lb, 10.5" Mosaic Pasta Bowl	403, 404, 406	4 ea	5.60/0.42
8918 $\Delta$	4 qt, 19" x 13.75" Oval Mosaic Platter	406	4 ea	12.25/0.95
8919 $\Delta$	2.9 qt, 9" x 12" Mosaic Baker	406	4 ea	7.25/0.49
8920 $\Delta$	4 qt, 10" x 14" Mosaic Baker	406	4 ea	8.10/0.62
<b>Plate Stands</b>				
7900 $\Delta$	2.75" H Plate Stand	02, 03	4 ea	4.03/0.51
7901 $\Delta$	4" H Plate Stand	02, 03	4 ea	4.36/0.49
<b>Scoop Bowl</b>				
0411	4 qt, 13.75" x 9.38" Scoop Bowl	02, 03	4 ea	5.69/0.74
<b>Corinthian Crocks &amp; Platter</b>				
6993	5 lb, 10.5" Corinthian Crock	02	6 ea	5.20/0.66
6996	10 lb, 12.5" Corinthian Crock	02	6 ea	7.50/0.97
6997	15.5 x 12" Corinthian Platter	02	6 ea	7.00/0.66

NSF Listed products are designated with a  $\Delta$

# DISPLAYWARE

## Tulip Deli® Crocks & Platter

- Beautiful swirl pattern and high gloss finish
- Crocks and platters nest for easy storage
- Durable SAN plastic is resistant to food oils and acids
- Safe for use in temperatures from 0° to 180°F
- Dishwasher safe

6966



6963



6963



6972

## Orchid® Deli Bowls

- Polycarbonate bowls and crocks have a beautiful, glass-like appearance without the breakage
- Extremely break-resistant material can be used in heated cases or on hot tiles up to 212°F
- Withstands exposure to food acids
- NSF Listed; dishwasher safe

6532



6534



6531



8887



8886



8888

## Octagon Bowls

- Contemporary octagonal shape is ideal for table service, buffets, salad bars or deli displays
- Made of glossy acrylic
- 8888 offers the increased durability of SAN and is safe for use in temperatures from 32° to 160°F
- Dishwasher safe



### Octagonal Crocks & Platter

- Crock inserts eliminate waste while giving a full appearance
- 2.5 lb low profile crock (6723) can be used as an insert for the 5 lb crock
- 5 lb low profile crock (6726) can be used as an insert for the 10 lb crock
- Durable SAN plastic is resistant to food oils and acids
- Safe for use in temperatures from 0° to 180°F
- Dishwasher safe



Prod No	Description	Color	Pack	Cs Wt/Cube
<b>Tulip Deli Crocks &amp; Platter</b>				
6963	5 lb, 10.38" x 6.75" Tulip Deli Crock	02, 03, 05	6 ea	5.46/0.57
6966	10 lb, 13" x 10.38" Tulip Deli Crock	02, 03, 05, 15	6 ea	8.20/1.02
6972	15.63" x 12" Tulip Deli Platter	03, 15	6 ea	7.45/0.63
<b>Orchid Deli Bowls</b>				
6531 $\Delta$	1.5 qt, 8" Orchid Deli Bowl	03	12 ea	4.70/0.51
6532 $\Delta$	3 qt, 10" Orchid Deli Bowl	03	12 ea	7.45/1.09
6534 $\Delta$	7 qt, 12" Orchid Deli Bowl	03	12 ea	12.55/1.84
<b>Octagon Bowls</b>				
8886	2.5 lb, 7.13" Octagon Bowl	03	4 ea	1.60/0.30
8887	5 lb, 9.19" Octagon Bowl	03	4 ea	3.25/0.55
8888	8 lb, 9.38" Dia Deep Octagon Bowl	03	4 ea	4.00/0.50
<b>Octagonal Crocks &amp; Platter</b>				
6713	5 lb, 10.63" x 7.19" Octagonal Crock	03	6 ea	5.25/0.58
6723	2.5 lb Low Profile Octagonal Crock (and Insert for 5 lb Crock 6713)	02, 03, 79	6 ea	4.50/0.42
6716	10 lb, 13.31" x 10.5" Octagonal Crock	03, 79	6 ea	8.20/1.02
6726	5 lb Low Profile Octagonal Crock (and Insert for 10 lb Crock 6716)	02, 03, 79	6 ea	7.60/0.63
6741	11.75" x 29.75" Octagonal Platter	03	6 ea	13.60/0.70

NSF Listed products are designated with a  $\Delta$

# DISPLAYWARE

## Modular Displayware

- Wave shape offers visual interest while enhancing the display
- Unique, flexible displayware provides an attractive solution for merchandising prepared food
- Fits in standard size food wells
- Half long lid can be used as a display tray for sliced deli meats and cheeses
- Made of tough, break-resistant polycarbonate
- Safe for use in temperatures ranging from -40° to 212° F
- NSF Listed; dishwasher safe



6984

6982

6982

6986



69866

69864  
with 6986L Lid

6986



69846  
6984L

6990

69844



Collar provides support for smaller pans when used in a food well



1. Place collar in food well



2. Drop pans into collar for an attractive display



### Rectangular Deli Crocks & Platter

- Rectangular deli crocks save space in display cases
- Acrylic crocks have a high gloss finish
- Safe for use in temperatures from 32° to 160°F
- Dishwasher safe

### Deliware® Rectangular Crocks

- Economical durable polypropylene for maximum impact resistance in cold temperatures
- Safe for use in temperatures from 32° to 170°F



Prod No	Description	Color	Pack	Cs Wt/Cube
<b>Modular Displayware</b>				
6982 Δ	4.45 qt Half Long Pan - Wavy Edge	03, 07	6 ea	9.30/1.26
6990 Δ	4.45 qt Half Long Pan - Straight Edge	03, 07	6 ea	9.37/1.06
6982L Δ	Half Long Lid	07	6 ea	5.11/0.40
6988 Δ	Half Long Collar	03, 07	6 ea	5.48/0.98
6984 Δ	6.5 cup, 2.5" Deep Half Size Pan	03, 07	6 ea	3.67/0.54
69844 Δ	9.25 cup, 4" Deep Half Size Pan	03, 07	6 ea	4.26/0.48
69846 Δ	13 cup, 6" Deep Half Size Pan	03, 07	6 ea	5.34/0.39
6984L Δ	Half Size Lid	07	6 ea	1.95/0.16
6986 Δ	4 cup, 2.5" Deep Third Size Pan	03, 07	6 ea	2.67/0.41
69864 Δ	5.6 cup, 4" Deep Third Size Pan	03, 07	6 ea	3.06/0.34
69866 Δ	7.8 cup, 6" Deep Third Size Pan	03, 07	6 ea	3.87/0.39
6986L Δ	Third Size Lid	07	6 ea	1.36/0.14
<b>Rectangular Deli Crocks &amp; Platter</b>				
8508	12" x 8" Rectangular Platter	03	6 ea	5.10/0.41
8819	5 lb, 10" x 6" Rectangular Crock	03	4 ea	2.80/0.55
8821	10 lb, 12" x 10" Rectangular Crock	03	4 ea	5.25/0.92
<b>Deliware Rectangular Crocks</b>				
8110	5 lb, 10" x 6" Rectangular Crock	02, 03	12 ea	7.30/1.18
8112	10 lb, 12.5" x 10.25" Rectangular Crock	02, 03	6 ea	8.75/1.13

NSF Listed products are designated with a Δ



# DISPLAYWARE

## Petal Mist® Plates, Bowls & Trays

- Petal Mist's delicate design gives an elegant appearance; perfect for buffets, food bars, delis, poolside, and catering
- Textured exterior hides scratches; easy-clean smooth interior
- Made of tough, break-resistant polycarbonate
- Safe for use in freezers and in temperatures from 40° to 212°F
- See page 24 for Petal Mist Dinnerware plates and bowls
- NSF Listed; dishwasher safe



## Bell Bowls

- Pebbled design made of crystal-clear acrylic
- 7325 pebbled bowl made of break-resistant polycarbonate
- 43811 heavy-weight melamine has coordinating single serving bowls shown on page 25
- Dishwasher safe

## Stack Bowls

- Use for food bars, buffets, or table service
- 15" deep rim gives a stylish bowl appearance when placed into ice or refrigerated food bar templates
- Acrylic is resistant to food acids and oils
- Dishwasher safe





### Leaf Bowls

- Perfect for salad bar or table service
- Acrylic is resistant to food acids and oils
- For use in temperatures from 32° to 160°F
- Dishwasher safe

### Buffet Clam Shells

- Perfect for presenting seafood, salads, and appetizers in a buffet or salad bar
- Durable SAN plastic is resistant to food oils and acids
- Safe for use in temperatures from 0° to 180°F
- Dishwasher safe



Prod No	Description	Color	Pack	Cs Wt/Cube
<b>Petal Mist Plates, Bowls &amp; Tray</b>				
6908 $\Delta$	1.2 qt, 7.5" Petal Mist Bowl	03, 07	36 ea	15.91/1.28
6909 $\Delta$	2.4 qt, 9" Petal Mist Bowl	03, 07	12 ea	8.15/0.69
6931 $\Delta$	3.4 qt, 9.75" Petal Mist Bell Bowl fits 8.25" template opening	03, 07	4 ea	4.10/0.54
6914 $\Delta$	5.6 qt, 12" Petal Mist Bowl	03, 07	4 ea	5.20/0.75
6917 $\Delta$	9.7 qt, 15" Petal Mist Bowl	03, 07	4 ea	8.05/1.17
6919 $\Delta$	17.2 qt, 18" Petal Mist Bowl	03, 07	4 ea	13.00/1.93
6942 $\Delta$	13" Petal Mist Plate	07	6 ea	5.50/0.28
6947 $\Delta$	16" x 22" Petal Mist Rectangular Tray	07	6 ea	15.80/0.45
<b>Bell Bowls</b>				
7325	3.3 qt, 11" Polycarbonate Pebbled Bowl	07	12 ea	9.46/0.73
SB90	3.3 qt, 11" Acrylic Pebbled Bowl	07	4 ea	4.00/0.56
SB94	6 qt, 14" Acrylic Pebbled Bowl	07	4 ea	6.25/0.88
43811	5 qt, 12" Melamine Salad/Serving Bowl	03, 05	6 ea	9.00/0.69
<b>Stack Bowls</b>				
8038	1.5 qt, 8" x 3.5" Stack Bowl	03	4 ea	2.85/0.55
8094	2.5 qt, 9" x 3.75" Stack Bowl	03	4 ea	3.00/0.56
8099	2.5 qt, 9" x 3.5" Stack Bowl	03	4 ea	2.85/0.55
8100	3 qt, 9.5" x 4" Stack Bowl	03	4 ea	3.10/0.53
<b>Leaf Bowls</b>				
LB10	1.5 qt, 9.38" Leaf Bowl	07	4 ea	2.80/0.42
LB12	3 qt, 11.25" Leaf Bowl	07	4 ea	4.00/0.65
LB16	8 qt, 15.38" Leaf Bowl	07	4 ea	7.00/1.48
<b>Buffet Clam Shells</b>				
339	12 oz, 8.88" x 5.5" Small Clam Shell	02, 03, 07	12 ea	5.90/0.60
0340	22 oz, 11" x 7" Medium Clam Shell	02, 03, 07	12 ea	10.75/1.15
0344 $\Delta$	5 qt, 19" x 12.88" Large Clam Shell	02, 03, 07	1 ea	3.25/1.20

NSF Listed products are designated with a  $\Delta$

# DISPLAYWARE

## Round Polycarbonate Pebbled Bowls

- Pebbled exterior resists scratches
- Smooth interior is unaffected by salad oils, food acids, or dressings
- Durable polycarbonate is safe for use in freezers and in temperatures from 40° to 212°F
- NSF Listed; dishwasher safe



## Acrylic Pebbled Bowls

- Acrylic bowls have heat polished, high-gloss rim
- Pebbled finish resists scratches
- Dishwasher safe



Prod No	Description	Color	Pack	Cs Wt/Cube
<b>Round Polycarbonate Pebbled Bowls</b>				
7206 $\Delta$	0.6 qt, 6" Round PC Bowl	07	12 ea	2.15/0.16
7208 $\Delta$	1.62 qt, 8" Round PC Bowl	07	12 ea	5.05/0.52
7210 $\Delta$	3 qt, 10" Round PC Bowl	07	12 ea	8.38/0.86
7212 $\Delta$	5.5 qt, 12" Round PC Bowl	07	12 ea	13.90/1.32
7215 $\Delta$	11 qt, 15" Round PC Bowl	07	4 ea	6.45/1.25
7218 $\Delta$	18 qt, 18" Round PC Bowl	07	4 ea	11.26/2.04
7223 $\Delta$	33 qt, 23" Round PC Bowl	07	4 ea	19.00/4.15
<b>Round Acrylic Pebbled Bowls</b>				
SB66	5 qt, 6" Acrylic Round Bowl	07	8 ea	1.80/0.14
SB68	1 qt, 8" Acrylic Round Bowl	07	4 ea	2.05/0.42
SB70	2 qt, 10" Acrylic Round Bowl	07	4 ea	3.45/0.42
SB72	4 qt, 12" Acrylic Round Bowl	07	4 ea	3.10/0.88
SB74	7 qt, 14" Acrylic Round Bowl	07	4 ea	6.37/0.87
SB76	10 qt, 16" Acrylic Round Bowl	07	4 ea	7.56/1.49
SB78	15 qt, 18" Acrylic Round Bowl	07	4 ea	10.20/2.49
SB79	24 qt, 22" Acrylic Round Bowl	07	4 ea	15.25/2.82
<b>Oval Acrylic Pebbled Bowls</b>				
OSB172	5.5 qt, 10.5" x 14" Acrylic Oval Bowl	07	4 ea	5.38/0.87
OSB176	11 qt, 13" x 18" Acrylic Oval Bowl	03, 07	4 ea	9.95/1.94
OSB178	15 qt, 15.25" x 21.88" Acrylic Oval Bowl	03, 07	4 ea	11.20/1.94

NSF Listed products are designated with a  $\Delta$

Shipping Notes: 7223 and SB79 can ship UPS/FedEx Ground at oversize cost

## Double-Wall Stainless Steel Displayware

- Beautiful heavy-duty, stainless steel displayware designed for delis, buffets, and special event service
- The modern hammered finish hides scratches for a longer life
- Double wall construction provides insulation to help with temperature retention with both hot and cold foods; no need to preheat or chill
- Double wall construction with air insulation prevents sweating for a fresher looking display
- 609201, 609202, 609203, and 609204 bowls have dual-base indentions allowing bowls to sit flat or at an angle for a more dramatic display and easy food access
- Keeps food under 41° F for up to 2 hours or more



### Double-Wall Insulation Maintains Serving Temps

#### Double Wall Construction/Air Insulation:

- Helps with temperature retention for both hot and cold foods
- Keeps food under 41° F for up to 2 hours or more

- 609211 3.5 qt, 10" Square Bowl
- 609209 4.38 qt, 10-3/4" Serving Bowl
- 609204 9.5 qt, 14" Dual Angle Bowl

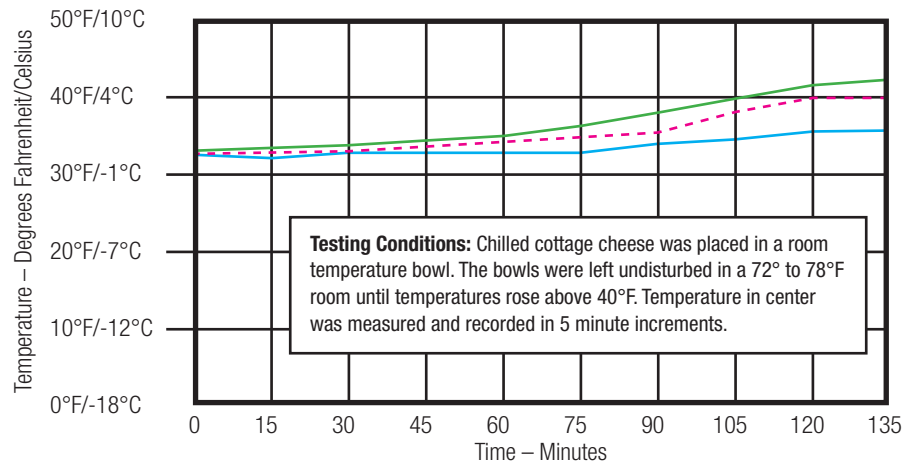

Prod No	Description	Color	Pack	Cs Wt/Cube
<b>Double-Wall Stainless Steel Displayware</b>				
609201	1.7 qt, 8" Dual Angle Bowl with Hammered Finish	—	2 ea	6.39/0.28
609202	3.38 qt, 10" Dual Angle Bowl with Hammered Finish	—	2 ea	7.94/0.70
609203	5.75 qt, 12" Dual Angle Bowl with Hammered Finish	—	2 ea	9.31/1.13
609204	9.5 qt, 14" Dual Angle Bowl with Hammered Finish	—	2 ea	11.69/2.02
609208	2.5 qt, 9.25" Serving Bowl with Hammered Finish	—	2 ea	7.28/0.60
609209	4.38 qt, 10.75" Serving Bowl with Hammered Finish	—	2 ea	8.60/0.88
609211	3.5 qt, 10" Square Bowl with Hammered Finish	—	2 ea	7.94/0.84
609215	12" x 7" Curved Tray with Hammered Finish	—	2 ea	6.44/0.37
609216	15" x 8.5" Curved Tray with Hammered Finish	—	2 ea	7.81/0.57

# DISPLAYWARE

## Aluminum Displayware

- Heavy-weight aluminum displayware is ideal for catering and display applications
- Durable polyester coating resists scratching and cracking better than enamel
- Aluminum material helps maintain consistent food temperature



600111



600220

600225



600214

600216



600112

600121

600122



609093



609083

609082

## Balti Dishes

- Handled bowls are great for food preparation and presentation, deli display, or family style dining
- High polish 18-2 stainless steel
- Dishwasher safe

## Square Display Dishes

- Handled bowls are great for food preparation and presentation, deli display, or family style dining
- Handles collapse to minimize display space used
- High polish 22 gauge stainless steel
- Dishwasher safe



## Allegro® & Maestro® Display Bowls

- Multi-purpose bowls for candies, fruit, dressings, sauces, and rolls
- Mirror-polished finish; 18-10 stainless steel
- Hand washing recommended



White(02)



Black(03)

Prod No	Description	Color	Pack	Cs Wt/Cube
<b>Aluminum Displayware*</b>				
600111	1" Deep Full Size Aluminum Food Pan	02, 03	1 ea	7.86/0.33
600112	2.5" Deep Full Size Aluminum Food Pan	02, 03	1 ea	8.75/0.44
600121	1" Deep Half Size Aluminum Food Pans	02, 03	1 ea	4.01/0.16
600122	2.5" Deep Half Size Aluminum Food Pans	02, 03	1 ea	4.53/0.22
600214	17" Round Aluminum Bell Bowl	02, 03	1 ea	4.65/0.82
600216	19" Round Aluminum Bell Bowl	02, 03	1 ea	5.75/1.02
600220	19" Aluminum Square Platter	02, 03	1 ea	6.40/0.43
600225	19" x 10" Aluminum I-Platter	02, 03	1 ea	4.18/0.23
<b>Balti Dishes - Stainless Steel</b>				
609092	20 oz, 6" Balti Dish	-	12 ea	7.49/0.29
609093	30 oz, 6.75" Balti Dish	-	12 ea	7.94/0.29
609094	44 oz, 7.5" Balti Dish	-	12 ea	9.70/0.45
609096	72 oz, 9.5" Balti Dish	-	12 ea	11.90/0.54
609097	96 oz, 10.25" Balti Dish	-	12 ea	12.23/0.77
<b>Square Display Dishes - Stainless Steel</b>				
609082	6" Square Display Dish	-	12 ea	10.58/0.18
609083	8" Square Display Dish	-	12 ea	19.18/0.44
609084	10" Square Display Dish	-	12 ea	19.18/0.44
609085	12" Square Display Dish	-	12 ea	23.37/0.62
609086	14" Square Display Dish	-	12 ea	27.56/0.82
<b>Allegro Display Bowls - Stainless Steel</b>				
609171	20 oz, 5.25" Allegro Display Bowl	-	6 ea	3.50/0.32
609172	26 oz, 5.88" Allegro Display Bowl	-	6 ea	4.00/0.43
609173	48 oz, 7" Allegro Display Bowl	-	3 ea	3.00/0.36
609196	3 qt, 9.5" Allegro Display Bowl	-	1 ea	2.00/0.29
<b>Maestro Display Bowls - Stainless Steel</b>				
609121	9.75" Maestro Slotted Bowl	-	6 ea	6.50/0.20
609123	7.88" Maestro Round Slotted Bowl	-	10 ea	6.50/0.19
609125	12" x 8.75" Maestro Oval Dish/Tray	-	6 ea	8.00/0.93

\*Note: Not for use in hot wells or ovens

# DISPLAYWARE

## Display Covers (Cover Only)

- Covers enhance and protect the look of your food items; helps keep food fresh
- Use for merchandising fresh fruits, desserts, salads, sandwiches, or bakery items
- Polycarbonate dome covers add increased durability and can be used in more extreme foodservice applications



PSD21EH

Use Display Covers with our full- and half-size food pans shown on pages 174 & 175



2512

3004

SC32

## Cake Covers & Tray

- Clear covers display desserts and pastries
- Sanitary covers help keep foods fresher longer
- Dishwasher safe

## Step Risers

- Step Risers create height in your food presentation
- Offers better visibility and helps merchandise foods

### Polycarbonate Step Risers

- 6843 polycarbonate riser is virtually unbreakable; won't dent or chip

### ABS Step Risers

- Edges have air slots for increased air circulation
- ABS plastic is very durable and easy to clean; will not warp or chip
- Textured satin finish decreases glare, hides scratches



6863

6843



Black(03)



Clear(07)

Prod No	Description	Color	Pack	Cs Wt/Cube
<b>Display Covers (Trays Not Included)</b>				
PSD13EH	12" x 10" End Cut Display Cover	07	1 ea	1.74/0.81
PSD13CH	12" x 10" Center Cut Display Cover	07	1 ea	1.74/0.81
PSD21EH	12" x 20" End Cut Display Cover	07	1 ea	3.88/1.72
PSD21CH	12" x 20" Center Cut Display Cover (7.88" x 6.75" opening)	07	1 ea	3.88/1.72
PSD21DEH	12" x 20" Double End Cut Display Cover	07	1 ea	3.88/1.72
<b>Cake Covers &amp; Tray</b>				
SC32	12" x 6" Cake Cover, Acrylic	-	6 ea	7.85/1.70
2512	12" x 6.5" Cake Cover, SAN	-	6 ea	9.95/1.95
3004	14" Display Tray, SAN	-	12 ea	11.10/0.55
<b>Step Risers</b>				
6843 $\Delta$	11.75" 3-Step Polycarbonate Riser	03	1 ea	5.16/1.03
6863	23.5" 3-Step Riser ABS Riser	03	1 ea	8.65/2.03

NSF Listed products are designated with a  $\Delta$



# BUFFET SERVICE

Carlisle's attractive collections display your food in style. With contemporary styling and an elegant presentation, Carlisle is able to meet all of your buffet service needs from urns to chafers and even elegantly styled servingware.

<b>Product</b>	<b>Page</b>
Adapter Bars .....	.85
Beverage Urns .....	82 & 84
Buffet Tongs .....	86 & 87
Chafers .....	82 & 83
Chafer Accessories .....	84 & 85
Chafer Replacement Parts .....	.298
Clutter Busters .....	.85
Display Stands .....	.90
Drip Trays .....	.90
Display Cubes .....	.89
Display Trays .....	.89
Ice Sculptures .....	.88
Illuminated Trays .....	.88
Ladles .....	.86

<b>Product</b>	<b>Page</b>
Marmites .....	.84
Pebbled Punch/Serving Bowls .....	.90
Punch/Serving Bowls .....	.90
Servers, Tiered .....	.90
Servingware	
Aria Servingware .....	.86
Crescendo Servingware .....	.86
Venico Servingware .....	.86
Spoons .....	.86
Tongs .....	86 & 87
Urns, Beverage .....	82 & 84
Universal Roll-Top Cover .....	.84
Universal Wire Lid Holder .....	.84
Water Pan, Electric .....	.85

# PREMIUM CHAFERS & URNS

## Premium Chafers & Urns

### Aspen Buffet Line

- The premium heavy-weight construction of Aspen Chafers and fine crafted, hand-finished materials combine to create the ultimate presentation for your buffet
- Heavy-weight chafers have solid legs and solid-weld construction
- Aspen combines elegant styling in gleaming care-free 18-10 stainless steel with chrome-plated legs
- Chafers offer a smooth gliding hinge for one-touch operation and their self-regulating lid opens to any position with a simple push
- Roll-Tops also feature a condensation return system and detachable covers for easy handling and cleaning
- Beautiful, clean styling and a smooth glide faucet
- Full drip guards keep tabletops clean
- Premium chafers come complete with 2.5" DuraPan™, water pan, fuel holder(s), and a Clutter Buster™ for storage and transport
- See pages 84 & 85 for a list of chafer accessories
- Replacement parts are listed on page 298



609720



609721



609725



609723



609576



609578



609600

### Quality Chafers

- Sophisticated collection of mid-weight chafers that offer solid-weld construction and heavy gauge, polished 18-8 stainless steel to resist corrosion
- Chafers come complete with 2.5" DuraPan, water pan, and fuel holder(s)
- 609600 opens to 90° position only
- 609576 & 609578 feature a slide lock, allows opening to 90° or 180° for serving versatility
- Protect your investment with Carlisle's sturdy Clutter Busters (sold on page 85)



609550



## Standard Chafers

### New World Collection™

- Distinctive styling, sturdy solid-weld construction and an economical price make the New World Collection one of our most popular lines
- Heavy gauge, mirror-polished 18-8 stainless steel resists corrosion
- Sturdy gold plated legs and handles
- 609550 rectangular chafer features dripless water pan
- Universal Lid Holders™ (shown on page 84) are included with each New World Chafer



609530



609510

Prod No	Description	Color	Pack	Cs Wt/Cube
<b>Premium Chafers &amp; Urns</b>				
609720	6 qt Aspen Round Roll-Top Chafer	—	1 ea	43.98/4.06
609721	8 qt Aspen Rectangular Roll-Top Chafer	—	1 ea	55.45/6.05
609723	3 gal Aspen Beverage Urn	—	1 ea	19.00/1.45
609725	5 gal Aspen Beverage Urn	—	1 ea	21.00/1.76
<b>Quality Chafers</b>				
609576	8 qt Times Square Rectangular Roll-Top Chafer	—	1 ea	32.00/3.91
609578	6 qt Times Square Round Roll-Top Chafer	—	1 ea	32.00/3.91
609600	8 qt Manhattan™ Roll-Top Chafer	—	1 ea	29.00/4.38
<b>Standard Chafers</b>				
609550	8 qt Magellan™ Rectangular Chafer	—	1 ea	17.80/2.26
609510	6 qt Pinta™ Oval Chafer	—	1 ea	14.00/2.09
609530	4 qt Nina™ Round Chafer	—	1 ea	10.80/1.63

# BEVERAGE URNS & ACCESSORIES

## Contemporary Beverage Urns

- Decorative spigot handle is threaded into a welded and sealed stainless steel tube to eliminate leaks
- Heavy-weight beverage urns have seamless, one-piece body and double-wall covers
- Heavy gauge, mirror-polished 18-8 stainless steel resists corrosion and is virtually maintenance free
- Urns have sturdy solid legs and welded construction
- Solid brass accents have a clear coating that protects against tarnish
- Comes complete with fuel holder
- Coordinates with chafers on pages 82 & 83



609635



609652

## Marmites

- An attractive way to keep soups and sauces warm
- Heavy gauge, high polish 18-8 stainless steel resists corrosion and is virtually maintenance free
- Servers come complete with inset, water pan, notched cover, and fuel holder(s)



609595

609595 Universal Wire Lid Holder



## Universal Wire Lid Holder

- Convenient, sanitary way to store covers for self-service in a small amount of space; helps prevent loss at offsite functions
- Allows condensation to run back into water pan, not on the table
- Attaches quickly and easily to all shapes and sizes of chafers with lift off covers
- Heavy gauge 18-8 stainless steel wire

## Universal Roll-Top Cover

- Turns an ordinary chafin into an elegant roll-top
- Unique design allows for front loading and easy replenishment; no brackets or clips required
- Mirror-polish finish with brass handles
- Fits most rectangular chafers with a dripless water pan



609590

## Electric Water Pan

- Use electric water pans to convert standard fuel chafers
- Electric water pan has adjustable thermostat and holds one full-size or two half-size 2.5" deep food pans
- Heating elements offer 450 watts of startup power; standard 110-120 volt, 60 Hz; UL listed
- Self-regulating heating element keeps food at correct serving temperatures; safety indicator light signals in-use
- At maximum setting, water in pan will be heated to approximately 185° F



### Cash 'N Carry

Selected products also available in a cash 'n carry pack. See page 277.



607830EW



607830EW shown with 609600 8 qt Manhattan™ Roll-Top Chafers

Electric Water Pan works with most standard size lift off lid chafers



609650E

609523E

609571E

## Clutter Busters™

- The perfect solution for chafers storage or transport for offsite catering
- Protects chafers from dents and scratches, keeping your chafers looking new longer
- Tough polyethylene construction with lockable hinged cover
- Clutter Busters stack for more efficient storage and nest for compact storage when empty

## Adapter Bars

- Offer greater flexibility
- Allows use of fractional size food pans in our chafers
- NSF Listed; dishwasher safe

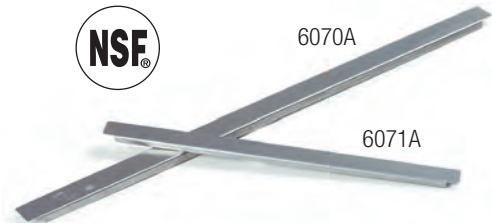

6070A

6071A

Prod No	Description	Color	Pack	Cs Wt/Cube
<b>Beverage Urns &amp; Marmites</b>				
609633	3 gal Contemporary Beverage Urn	—	1 ea	21.00/1.92
609635	5 gal Contemporary Beverage Urn	—	1 ea	28.00/3.13
609651	4 qt Standard Marmite	—	1 ea	4.63/0.42
609652	7 qt Standard Marmite	—	1 ea	7.28/0.79
<b>Universal Wire Lid Holder</b>				
609595	Universal Wire Lid Holder	—	1 ea	0.60/0.10
<b>Universal Roll-Top Cover</b>				
609590	Universal Roll-Top Cover	—	1 ea	12.00/1.70
<b>Electric Water Pan</b>				
607830EW <b>C</b>	Electric Water Pan	—	1 ea	6.52/1.50
<b>Adapter Bars</b>				
6070A <b>Δ</b>	20.5" Adapter Bar	—	12 ea	6.00/0.24
6071A <b>Δ</b>	12.75" Adapter Bar	—	12 ea	3.00/0.09
<b>Clutter Busters</b>				
609650E	Clutter Buster for 609576, 609578, 609600, 609720, 609721	—	1 ea	18.75/7.48
609523E	Clutter Buster for 609530	—	1 ea	9.00/3.16
609571E	Clutter Buster for 609510, 609550	—	1 ea	13.00/4.80

NSF Listed products are designated with a **Δ**

Cash 'N Carry products are designated with a **C**



# SERVINGWARE

## Servingware

- Beautiful gleaming mirror polished stainless steel
- Dishwasher safe
- Durable sanitary one-piece construction

### Crescendo™ Servingware

- Exclusive design features a perfectly balanced hollow handle that is contoured to fit the hand
- Bold and dramatic look lends a unique sophistication to any buffet setting



### Venico™ Servingware

- Adds a classic & sophisticated look to your serving line
- Made from a solid piece of stainless steel with beautiful mirror-finish
- Light-weight; crafted with hollow handles
- Dishwasher safe

### Aria™ Servingware

- Heavy-duty, and more economical than comparable hollow handle items
- Ladles have one ounce oval shaped bowl for pouring dressings from either side





## Buffet Tongs

- Heavy-duty 18-8 stainless steel with mirror polished finish for long lasting use
- Durable sanitary one-piece construction
- Scissor tongs are two-piece satin finish construction
- Dishwasher safe



Prod No	Description	Color	Pack	Cs Wt/Cube
<b>Crescendo Servingware</b>				
609030	12" Crescendo Solid Spoon	—	12 ea	4.20/0.11
609031	12" Crescendo Slotted Spoon	—	12 ea	4.10/0.11
609036	14" 4 oz Crescendo Ladle	—	12 ea	6.80/0.16
609039	12" Crescendo Cake Server	—	12 ea	5.30/0.11
<b>Venico Servingware</b>				
607650	11" Venico Solid Spoon	—	12 ea	3.00/0.08
607651	11" Venico Slotted Spoon	—	12 ea	3.00/0.08
607652	11" Venico Pastry Server	—	12 ea	3.00/0.08
607653	10.5" Venico Pie Server	—	12 ea	4.00/0.09
607654	14" Venico Perforated Turner	—	12 ea	4.00/0.09
607655	11" Venico Ladle with Spout, 1 oz	—	12 ea	4.00/0.09
607656	11" Venico Ladle with Spout, 2 oz	—	12 ea	5.00/0.16
607657	12" Venico Ladle, 4 oz	—	12 ea	6.00/0.19
607658	11" Venico 4-Tine Meat Fork	—	12 ea	6.00/0.07
<b>Aria Servingware</b>				
609001	12" Aria Solid Spoon	—	12 ea	4.00/0.26
609002	12" Aria Slotted Spoon	—	12 ea	3.50/0.08
609003	11.5" Aria Notched Spoon	—	12 ea	3.50/0.08
609005	10.75" Aria Cold Meat Fork	—	12 ea	2.50/0.05
609006	11.75" Aria Wide Pie Server	—	12 ea	5.00/0.11
609007	11" Aria Narrow Pastry Server	—	12 ea	4.00/0.04
609009	10" Aria Solid Spoon	—	12 ea	3.00/0.06
600295	9.5" Aria Ladle	—	12 ea	2.90/0.08
600296	13.5" Aria Ladle	—	12 ea	3.10/0.10
604460	9.25" Aria Solid Spoon	—	12 ea	2.60/0.03
604606	6" Aria Salad Tong	—	12 ea	1.96/0.04
604609	9" Aria Salad Tong	—	12 ea	3.20/0.07
<b>Buffet Tongs</b>				
607680	8" Pastry Tong	—	12 ea	4.00/0.16
607682	8" Serving Tong	—	12 ea	3.25/0.17
607683	10.25" Scalloped Serving Tong	—	12 ea	2.80/0.25
607685	10" Scissors Salad Tong	—	12 ea	6.30/0.30
607687	9.25" Bread Serving Tong	—	12 ea	4.00/0.18
607690	5.75" Ice Tong	—	12 ea	1.50/0.07
607691	7" Ice Tong	—	12 ea	0.20/0.01
607692	10" Scalloped Bread Serving Tong	—	12 ea	1.00/0.05
607693	9" Salad Tong	—	12 ea	3.50/0.19
607695	9.5" Pastry Tong	—	12 ea	3.00/0.17
607697	11.75" Serving Tong	—	12 ea	0.60/0.05

# ICE SCULPTURES



SHR1



SGR1



SCL1



SSW1



SEA1



SD01



SBA1



SBG1



SFI1

## Illuminated Trays

- Perfect for use at buffets or banquets, or as an accent for ice sculptures
- Light boxes come with Blue, Red, and Yellow colored panels
- Light box is UL listed, fuse protected and operates on 115 volt/60 cycle AC
- Drain kits included

## Ice Sculptures

- Quick and easy way to turn any table into a showpiece
- Fill mold with water, freeze (48-72 hours), and cut open the mold
- Features patented EZ-Cut Bead™ and Contracting Cone Base™
- One time use
- Instructions included with every Ice Sculpture

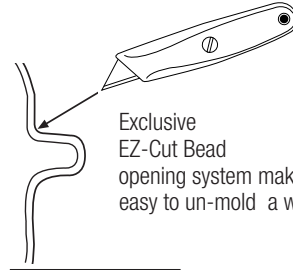

Exclusive EZ-Cut Bead opening system makes it quick and easy to un-mold a work of art.

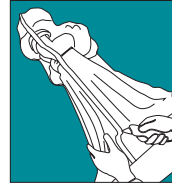

Contracting Cone Base allows for expansion while freezing to eliminate the major cause of cracking and breaking in the freezing process.

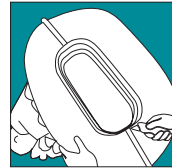

SL6011L

SL6011TC\*

## MirAcryl™ Cubes

- Design allows smaller size cubes to nest inside larger cubes for convenient storage
- Invert to use as ice bucket or wine server
- Light-weight, break-resistant acrylic



## MirAcryl Mirrored Display Trays

- Beautiful, durable display pieces are easy to clean
- Made of light-weight acrylic
- Two-sided surface – use Mirrored or solid Black side for display

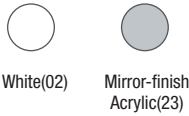

Prod No	Description	Color	Pack	Cs Wt/Cube
<b>Ice Sculptures</b>				
SHR1	Heart: 23.75" L x 14" W x 27.5" H	02	1 ea	9.55/5.36
SGR1	Grecian Bowl: 20.5" L x 23.5" W x 13.5" H	02	1 ea	11.00/6.24
SSW1	Swan: 19" L x 12" W x 21.5" H	02	1 ea	5.90/3.03
SD01	Dolphin: 20.5" L x 14.25" W x 25" H	02	1 ea	9.00/5.38
SBG1	Bride and Groom: 22" L x 14" W x 28" H	02	1 ea	6.03/5.60
SCL1	Clam Shell: 18" L x 12" W x 19" H	02	1 ea	6.50/4.74
SEA1	Eagle: 15.5" L x 24" W x 29" H	02	1 ea	8.00/6.56
SBA1	Basket: 18" L x 12" W x 19" H	02	1 ea	6.60/4.75
SFI1	Fish: 18" L x 12" W x 26" H	02	1 ea	6.70/5.62
<b>Illuminated Trays</b>				
SL6011L	Large Light Box (no tray)	00		22.30/2.51
SL6011TC*	Large Smooth Light Box Tray (only)	00	1 ea	16.10/3.21
<b>MirAcryl Cubes</b>				
SMMC8	8" Mirror Cube	23	1 ea	4.20/0.56
SMMC10	10" Mirror Cube	23	1 ea	6.35/0.88
SMMC12	12" Mirror Cube	23	1 ea	13.65/1.42
<b>MirAcryl Mirrored Display Trays</b>				
SMOC16	16" Octagon MirAcryl Tray	23	1 ea	3.50/0.15
SMOC24	24" Octagon MirAcryl Tray	23	1 ea	7.35/0.39
SMO1624	24" x 16" Oval MirAcryl Tray	23	1 ea	5.50/0.34
SMO2232	32" x 22" Oval MirAcryl Tray	23	1 ea	9.05/0.64
SMO2448	48" x 24" Oval MirAcryl Tray	23	1 ea	13.90/1.18
SMR1624	24" x 16" Rectangle MirAcryl Tray	23	1 ea	6.20/0.34
SMR1836	36" x 18" Rectangle MirAcryl Tray	23	1 ea	10.30/0.99
SMR2448	48" x 24" Rectangle MirAcryl Tray	23	1 ea	17.05/1.00
SMR12	12" Round MirAcryl Tray	23	1 ea	1.75/0.12
SMR16	16" Round MirAcryl Tray	23	1 ea	3.20/0.15
SMR24	24" Round MirAcryl Tray	23	1 ea	7.10/0.34
SMR32	32" Round MirAcryl Tray	23	1 ea	13.15/0.75
SMTD16	16" Teardrop MirAcryl Tray	23	1 ea	3.35/0.15
SMTD24	24" Teardrop MirAcryl Tray	23	1 ea	7.10/0.37

\* Drain Kits are included with Light Box Tray  
 NOTE: Light Boxes & Trays are sold separately; MirAcryl™ is not returnable if the protective film is removed;  
 SGR1, SHR1, SD01, SBG1, SCL1, SEA1, SBA1, SFI1, and SMR2448 can be shipped UPS/FedEx Ground at oversize cost

# BUFFET ACCESSORIES



609170



SP18



609310

609316

## Allegro™ Display Stand

- Heavy-weight bases with argon welding for exceptional strength
- Mirror-polished finish
- 18-10 stainless steel
- Handwashing recommended

## Pebbled Punch/Serving Bowls

- Pebbled exterior hides scratches
- Break-resistant acrylic
- Safe for use in temperatures from 32° to 160°F

## Punch/Serving Bowls

- Mirror-polished finish exterior and rim, satin finish interior
- Heavy gauge 18-8 stainless steel with argon welded bases for exceptional strength
- Handwashing recommended

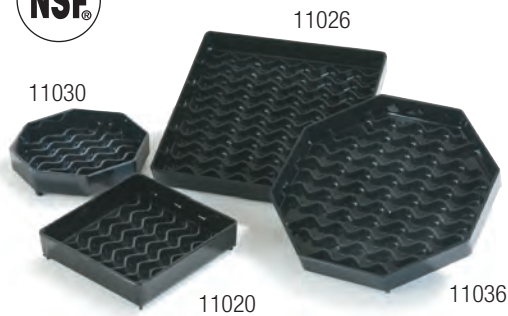

11030

11026

11020

11036

## NeWave™ Drip Trays

- Patented NeWave Drip Trays with open, free-flowing design dissipates fluid spills evenly to allow quicker evaporation
- NeWave pattern keeps mug, cup, and pitcher bases dryer by eliminating the common fluid traps on other designs
- Easy to empty and clean
- NSF Listed; dishwasher safe



Black(03)



Clear(07)

Prod No	Description	Color	Pack	Cs Wt/Cube
<b>Allegro Display Stand</b>				
609170	Allegro Three Tier Display Stand	—	1 ea	7.00/0.42
<b>Punch/Serving Bowls</b>				
SP18	26 qt, 17.5" Pebbled Punch Bowl	07	1 ea	5.60/2.49
SP22	24 qt, 22" Pebbled Punch Bowl	07	1 ea	8.20/4.30
609310	10 qt, 15.5" Punch/Serving Bowl	—	1 ea	5.50/3.34
609316	16 qt, 18" Punch/Serving Bowl	—	1 ea	8.00/5.02
<b>NeWave Drip Trays</b>				
11020 $\Delta$	NeWave 4" Square Drip Tray	03	12 ea	1.95/0.15
11030 $\Delta$	NeWave 4" Octagon Drip Tray	03	12 ea	1.70/0.13
11026 $\Delta$	NeWave 6" Square Drip Tray	03	12 ea	4.00/0.30
11036 $\Delta$	NeWave 6" Octagon Drip Tray	03	12 ea	3.40/0.30

NSF Listed products are designated with a  $\Delta$

Octagonal Drip Tray U.S. Patent No. D-418,376;  
 Rectangular Drip Tray U.S. Patent No. D-418,377





# FOOD BARS & CONVENIENCE

Offering your customers a clean and safe food bar experience is of the utmost importance to you and to Carlisle. We offer a complete selection of items to satisfy your need to have versatile, convenient products in every part of your restaurant – from customer-friendly innovations for front of house to rugged and smart products for back of house.

<b>Product</b>	<b>Page</b>
Adjustable Cup Dispensers . . . . .	106
Classic Crock Condiment Station . . . . .	97
Classic Crocks . . . . .	96
Coldmaster Coldbowl . . . . .	95
Coldmaster Coldcrock & Accessories . . . . .	94
Coldmaster Coldpans . . . . .	93
Coldmaster Condiment Bar Organizers . . . . .	95
Coldmaster Dispenser . . . . .	95
Coldmaster Ice Cream Server & Lid . . . . .	94
Coldmaster Standard Food Pans & Lids . . . . .	92
Condiment Caddy, 6-Compartment . . . . .	107
Counter Top Lid & Straw Dispenser . . . . .	107
Dispensers . . . . .	107
Electric Kettle . . . . .	102
Five★Star Buffet Bars . . . . .	102
Food Stations . . . . .	104
Gourmet Crocks . . . . .	96
Gravity Feed Cup Dispensers . . . . .	106
High Volume Condiment Pump . . . . .	105

<b>Product</b>	<b>Page</b>
Inside The Coldmaster Solution . . . . .	92
Insulated Topping Rails . . . . .	105
Ladles . . . . .	98
Lid & Condiment Organizer . . . . .	107
Maximizer™ Food Bar . . . . .	100
Packet Racks . . . . .	104
Pastry Display Cases . . . . .	103
Poly-Tuf Crocks . . . . .	96
Round Beverage Dispensers . . . . .	108
Salad Spoon . . . . .	99
Serving Spoons, Buffet Spoons & Pasta Forks . . . . .	99
Six★Star Food Bars . . . . .	101
Sneeze Guards . . . . .	102
Square Beverage Dispenser . . . . .	108
Standard Pump Kit . . . . .	104
Standard Topping Rails . . . . .	105
Supreme Crocks . . . . .	96
Tongs . . . . .	98
TrimLine Rectangular Beverage Dispensers . . . . .	108

# COLDMASTER®

## The Coldmaster Story

- Coldmaster system eliminates the inconvenience and mess of ice, as well as reduces the potential for bacteria

## Coldmaster Products Exceed Health Department Requirements

- With one overnight charge in your freezer, each Coldmaster keeps food at or below the ServSafe®\* guidelines of 40°F for up to eight hours\*\*

## Coldmaster Products Meet FDA Standards

- All Coldmaster products are filled with an exclusive non-toxic refrigerant gel
- Constructed of high-impact ABS plastic
- Dishwasher safe



## Inside The Coldmaster Solution:

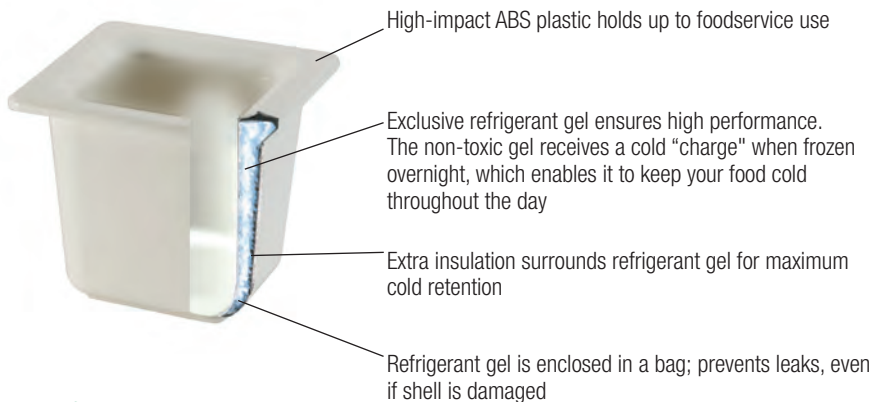

## Coldmaster Standard Food Pans & Lids

### Designed to fit in Standard Sized Food Pan Templates

- Save time and labor by placing food directly into Coldmaster Standard Pans
- Third-size divided splits into two sixth-size food pans
- NSF Listed



\*ServSafe is a registered trademark of the National Restaurant Association

## Coldmaster® Coldpans

Designed with the same capacity as traditional style food pans; will hold DuraPan™ Food Pans (page 174 & 175)

- Designed to hold and keep standard food pans cold
- CM1049 Pan Organizer is a 6" deep full size coldpan designed to hold (9) ninth-size food pans for easy organization
- NSF Listed



Prod No	Description	Color	Pack	Cs Wt/Cube
<b>Coldmaster Standard Food Pans &amp; Lids</b>				
CM1100 Δ	6" Deep Full-size Food Pan	02, 03	1 ea	11.45/1.16
CM1101 Δ	6" Deep Half-size Food Pan	02, 03	1 ea	5.40/0.57
CM1102 Δ	6" Deep Third-size Food Pan	02, 03	1 ea	4.45/0.39
CM1103 Δ	6" Deep Third-size Divided Food Pan	02, 03	1 ea	4.45/0.39
CM1104 Δ	6" Deep Sixth-size Food Pan	02, 03	1 ea	2.35/0.22
CM1105 Δ	6" Deep High Capacity Sixth-size Food Pan	02, 03	1 ea	2.20/0.26
CM1125	Full-size Coldmaster Lid	07	2 ea	3.80/1.20
CM1126	Half-size Coldmaster Lid	07	2 ea	2.37/0.41
CM1127	Third-size Coldmaster Lid	07	2 ea	1.90/0.41
CM1128	Sixth-size Coldmaster Lid	07	2 ea	1.37/0.21
<b>Coldmaster Coldpans</b>				
CM1042 Δ	6" Deep Full-size Coldpan (will hold full-size or 2 half-size pans)	02, 03	1 ea	18.85/1.83
CM1049	6" Deep Full-size Coldpan with Organizer (does not include food pans)	02	1 ea	20.00/1.83
CM1040 Δ	4" Deep Full-size Coldpan (will hold full-size or 2 half-size pans)	02	1 ea	11.45/1.15
CM1042LP	Full Size Coldpan Lid (fits CM1040, CM1042 and CM1049)	02	1 ea	3.20/0.43
CM1043 Δ	6" Deep Half-size Long Coldpan	02	1 ea	12.00/1.14
CM1045 Δ	6" Deep Third-size Coldpan	02	1 ea	8.80/0.75
CM1046 Δ	6" Deep Two-Thirds size Coldpan	02	1 ea	13.75/1.23

NSF Listed products are designated with a Δ

\*\*Temperature retention is based on crocks being pre-frozen for a minimum of eight hours, then filled directly with pre-chilled foods. Testing was conducted under ambient room temperatures of 76°F.





# COLDMASTER (CONT)



CM1012 with 38655 Shroud

## Coldmaster Ice Cream Server & Lid

- Coldmaster technology and benefits (see page 92)
- Accommodates standard 3-gallon ice cream tubs
- Free clear polycarbonate lid included with each Coldmaster Ice Cream Server
- Replacement Lids (CM1013) also available.

## Coldmaster Ice Cream Shroud

- Attractive stainless steel cover offers an upscale appearance



### Cash 'N Carry

Selected products also available in a cash 'n carry pack. See page 277.



CM1012



CM1030

## Coldmaster Coldcrock & Accessories

- Same Coldmaster technology and benefits (see page 92)
- Crock holds 2 quarts of salad, dressing, or condiments
- NSF Listed

### Accessories

- Use Standard Pump (CM1035) with ketchup, mayonnaise, mustard, or other sauces; can be used with or without insert to provide accurate .5 ounce or 1 ounce portions
- Fixed Nozzle Pump (38600R) dispenses 1 ounce per stroke; flow back design prevents messy dripping
- Maxi Pump (CM1037) dispenses 1 ounce portions of salsa, dressings, and other chunky condiments
- Maxi Pump's long nozzle allows easier dispensing; comes with snap-in nozzle restrictors to help eliminate dripping when dispensing thinner condiments



CM1033P



CM1032



CM1033



CM1030



CM1037



CM1035



38600R



Use Sparta® Brush 40155 for cleaning crock pumps



### Coldmaster Condiment Bar Organizers

- CM1069 organizer holds three 2 quart Coldcrocks; CM1065 organizer holds six 2 quart Coldcrocks
- Organizer is made of sturdy, high-impact plastic
- Textured exterior hides scratches
- Order organizer separately or as a set with crocks, lid and pumps (CM1058)
- Coldcrocks (CM1030) sold separately; see facing page for details



CM1058

CM1065 with Coldmaster Crocks



CM1050



CM1017

### Coldmaster Coldbowl

- Coldmaster technology and benefits (see page 92)
- Keeps food at or below 40°F for five hours
- Coldbowl's 12 quart capacity is perfect for buffets and food bars
- NSF Listed

### Coldmaster Dispenser

- Coldmaster technology & benefits
- Perfect for milk, cream and other temperature sensitive condiments
- Faucet style dispenser offers better control for dispensing liquids



White(02)



Black(03)



Clear(07)



Gray(23)

Replacement Parts shown on page 301

Prod No	Description	Color	Pack	Cs Wt/Cube
<b>Coldmaster Ice Cream Server, Lid &amp; Shroud</b>				
CM1012 $\Delta$ <b>C</b>	3 gal Coldmaster Ice Cream Server	02, 03	1 ea	7.25/1.05
CM1013	Lid for Coldmaster Ice Cream Server	07	1 ea	1.50/0.68
38655	Coldmaster Ice Cream Shroud	—	1 ea	9.00/1.27
<b>Coldmaster Coldcrock &amp; Accessories</b>				
CM1030 $\Delta$	2 qt Coldcrock (includes Coaster)	02, 03, 23	1 ea	3.90/0.27
CM1032	Clear Solid Lid	07	2 ea	0.47/0.09
CM1033	Clear Slotted Lid	07	2 ea	0.47/0.09
CM1033P	Clear Pump Lid (use with pumps below)	07	2 ea	0.47/0.09
CM1035	.5 or 1 oz Standard Pump	02	2 ea	0.75/0.10
CM1037	1 oz Maxi Pump includes 2 sizes Nozzle Restrictors	02	2 ea	1.00/0.27
38600R	1 oz Fixed Nozzle Pump	—	1 ea	0.45/0.13
<b>Coldmaster Condiment Bar Organizers</b>				
CM1058	Crock & Organizer Condiment Set includes 3-Crock Coldcrock Organizer, and 3 ea Coldmaster Crocks, Pump Lids, and Condiment Pumps	02, 03	1 set	18.90/2.96
CM1065	6-Crock Coldcrock Organizer (only)	02	1 ea	5.05/1.48
CM1069	3-Crock Coldcrock Organizer (only)	02	1 ea	3.95/1.37
<b>Coldmaster Coldbowl</b>				
CM1050 $\Delta$	12 qt, 18" Coldbowl	02	1 ea	7.55/1.14
<b>Coldmaster Dispenser</b>				
CM1017	5 qt Coldmaster Milk Dispenser & Lid	03	1 ea	6.88/0.88

NSF Listed products are designated with a  $\Delta$

Cash 'N Carry products are designated with a **C**

# CROCKS

## Classic Crock

- Thick-walled, heavy-weight design; made of SAN
- Excellent chemical resistance to food acids and dressings
- High-gloss finish is extremely scuff-resistant
- 0° to 180°F temperature range
- 0.6 quart crock fits inside 1.2 quart crock for smaller portions
- Translucent snap-on lids included
- NSF Listed; dishwasher safe



## Poly-Tuf™ Crock

- Optimum wall design gives greater break-resistance
- Glossy-finish crocks resist chipping and cracking
- Withstands temperatures from 32° to 180° F
- Translucent snap-on lids included
- NSF Listed; dishwasher safe



## Supreme Crock

- Same features as our Classic Crock but with a 1.5" deep rim
- Gives a stylish bowl-like appearance when dropped into food bar templates
- 6.5" diameter (under rim) fits most template openings
- Translucent snap-on lids included
- NSF Listed; dishwasher safe

0365



## Gourmet Crock

- Unique bowl shaped rim with deep crock base
- Stylish frosted pattern on rim helps hide scratches
- Break-resistant polycarbonate takes heat up to 212°F
- Translucent snap-on lids included
- NSF Listed; dishwasher safe



## Classic Crock Condiment Station

- Includes organizer, three clear 2.7 quart Classic Crocks with Standard Pumps and Lids
- Organizer made of durable, scratch-resistant textured ABS plastic
- Holds standard size one gallon condiment or 2.7 quart Classic Crocks



0306



Replacement Parts shown on page 301

Prod No	Description	Color	Pack	Cs Wt/Cube
<b>Classic Crocks</b>				
0300 $\Delta$	0.6 qt Classic Crock with Lid	03	12 ea	3.55/0.60
0301 $\Delta$	1.2 qt Classic Crock with Lid	01, 02, 03, 06, 07	12 ea	7.30/1.17
0316 $\Delta$	1.5 qt Classic Crock with Lid	01, 03, 06, 07	6 ea	6.00/0.81
0302 $\Delta$	2.7 qt Classic Crock with Lid	01, 02, 03, 06, 07	6 ea	7.10/1.25
0304 $\Delta$	4.0 qt Classic Crock with Lid	03	6 ea	11.30/1.91
<b>Poly-Tuf Crocks</b>				
0341 $\Delta$	1.2 qt Poly-Tuf Crock with Lid	01, 03, 06	12 ea	6.20/1.19
0343 $\Delta$	1.5 qt Poly-Tuf Crock with Lid	01, 03, 06	6 ea	4.05/0.84
0342 $\Delta$	2.7 qt Poly-Tuf Crock with Lid	01, 03, 06	6 ea	5.40/1.30
<b>Replacement Lids For Classic &amp; Poly-Tuf Crocks</b>				
0311 $\Delta$	Lid - 0.6/1.2 qt (fits 0300, 0301, 0341)	30	12 ea	0.60/0.09
0202 $\Delta$	Lid - 1.5/2.7 qt (fits 0302, 0316, 0342, 0343)	30	6 ea	1.26/0.12
0602 $\Delta$	Lid - 4 qt (fits 0304)	30	6 ea	2.00/0.21
<b>Supreme Crocks</b>				
0365 $\Delta$	1.5 qt Supreme Crock with Lid	03, 07	6 ea	5.30/0.84
0372 $\Delta$	2.7 qt Supreme Crock with Lid	03	6 ea	7.75/1.31
0202 $\Delta$	Replacement Lid - 1.5/2.7 qt (fits 0365, 0372)	30	12 ea	1.26/0.12
<b>Gourmet Crocks</b>				
7039 $\Delta$	Gourmet Crock with Lid	03, 07	6 ea	4.43/0.66
7038 $\Delta$	Replacement Lid	30	12 ea	1.30/0.22
<b>Classic Crock Condiment Station</b>				
0306	3-Crock Condiment Station Kit (includes three clear crocks, pumps, and lids)	00	1 ea	5.85/1.05

NSF Listed products are designated with a  $\Delta$

## COLOR-COORDINATED ACCESSORIES

Tongs, ladles, and spoons are a one-piece construction and available in a variety of colors.



### Tongs

#### High Temperature Carly® Tongs

- Carries a two-year warranty
- Made of revolutionary plastic material for strength and longevity
- Can be used on high temperature surfaces like steam tables
- Withstands heat up to 300°F
- NSF Listed; dishwasher safe

#### Clear Carly Tongs

- Break-resistant polycarbonate
- Recommended for temperatures up to 212°F; and dry heat up to 270°F
- NSF Listed; dishwasher safe

### Ladles

#### Carly Ladles

- Carries a two-year warranty
- 1 ounce, oval-shaped bowl allows pouring from both sides
- Available in 9.5" and 13.5" lengths
- NSF Listed; dishwasher safe

#### Standard Ladles

- Carries a two-year warranty
- .75 ounce bowl with spouts on each side for easy pouring
- Available in 10.5" length
- NSF Listed; dishwasher safe





### Serving Spoons, Buffet Spoons & Pasta Forks

- Carries a two-year warranty
- Recommended for temperatures up to 212°F
- Withstands dry heat up to 270°F
- Serving Spoons have notch in handle so spoon can rest on edge of food pan
- NSF Listed; dishwasher safe

### Salad Spoon

- Large flat edge for easy scooping
- 7.25" handle for easy reach
- Durable SAN material
- NSF Listed; dishwasher safe

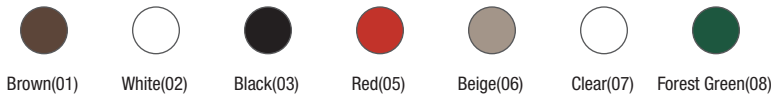

Prod No	Description	Color	Pack	Cs Wt/Cube
<b>Tongs</b>				
4606 Δ	6" Carly Salad Tong	01, 02, 03, 05, 06	12 ea	1.06/0.13
4006 Δ	6" Carly Salad Tong	07	12 ea	1.06/0.13
4609 Δ	9" Carly Salad Tong	01, 02, 03, 05, 06, 08	12 ea	2.30/0.25
4009 Δ	9" Carly Salad Tong	07	12 ea	2.30/0.25
4709 Δ	9" Carly Utility Tong	01, 02, 03, 05, 06, 08	12 ea	2.00/0.26
4109 Δ	9" Carly Utility Tong	07	12 ea	2.00/0.26
4712 Δ	12" Carly Utility Tong	01, 02, 03, 05, 06	12 ea	2.60/0.26
4112 Δ	12" Carly Utility Tong	07	12 ea	2.60/0.26
4806 Δ	6" Carly Pom Tong	01, 03, 06	12 ea	0.85/0.12
4206 Δ	6" Carly Pom Tong	07	12 ea	0.85/0.12
<b>Ladles</b>				
0295 Δ	9.5" Carly Ladle	01, 02, 03, 05, 06, 07	12 ea	1.00/0.12
0296 Δ	13.5" Carly Ladle	03	12 ea	1.25/0.15
0287 *	9.5" Carly Ladle (Assorted Imprinted)	03	1 set	0.90/0.12
0240 Δ	10.5" Ladle	03, 07	48 ea	4.70/0.58
0261 *	10.5" Ladle (Assorted Imprinted)	03	1 set	1.15/0.23
<b>Spoons &amp; Pasta Fork</b>				
4410 Δ	11" Solid Serving Spoon	02, 03, 05, 06, 07, 08	12 ea	1.40/0.13
4411 Δ	11" Perforated Serving Spoon	03, 07	12 ea	1.39/0.13
4420 Δ	13" Solid Serving Spoon	02, 03, 05, 06, 07	12 ea	1.66/0.17
4421 Δ	13" Perforated Serving Spoon	02, 03	12 ea	1.57/0.17
4430 Δ	15" Solid Serving Spoon	03, 07	12 ea	1.80/0.19
4431 Δ	15" Perforated Serving Spoon	03	12 ea	1.75/0.19
4450 Δ	.25 oz, 8" Solid Buffet Spoon	03, 06, 07	12 ea	0.50/0.05
4460 Δ	.5 oz, 8" Solid Buffet Spoon	01, 02, 03, 05, 06, 07, 08	12 ea	0.55/0.05
4470 Δ	.75 oz, 10" Solid Buffet Spoon	01, 03, 05, 06, 07	12 ea	0.76/0.07
4471 Δ	.75 oz, 10" Perforated Buffet Spoon	01, 03, 06	12 ea	0.70/0.07
4355	9.5" Pasta Fork	03	12 ea	1.10/0.19
509 Δ	11" Salad Spoon	01, 03	48 ea	3.50/0.58

NSF Listed products are designated with a Δ  
 Note: \*Assortment Packs includes one each of Bleu Cheese, Lo-Cal, Italian, House, French, Ranch, Thousand Island, & Caesar, plus four plain Imprinted Ladles: Handle imprinted in white with dressing name

# FOOD BARS

## Maximizer™ Food Bar

- 6 foot Maximizer Food Bar offers upscale European styling
- Holds six full size food pans (20% more than any other similar system)
- Use with ice or with Coldmaster® Standard Food Pans to keep food at 40°F or below for up to eight hours
- Double-sided acrylic sneeze guard attaches to post with six screw-in knobs
- Basin and cabinet come assembled - no tools required
- Replacements parts shown on pages 299 & 300
- NSF Listed



7711



Tilting sneeze guard makes it easier to clean and fill food bar and can be used as a service line sandwich bar



See our money saving coupon online at [www.carlislefsp.com/ecoupons](http://www.carlislefsp.com/ecoupons)



## Adapter Bars

Use with various food pans to set up a number of food bar configurations, see page 176 for more information

Double-sided extra-wide sneeze guard allows service from both sides

Easy-grip recessed handles in each corner of the basin for maneuverability

Four swivel, non-marking casters with brakes offer greater portability and stability



Molded from durable polyethylene and filled with thick polyurethane foam to keep food at correct serving temperatures for hours

Includes removable basin dividers

Built in food pan carriers have easy-open one-touch latch; use CaterCoolers™ (found on page 136) to keep foods cold even longer

Additional storage compartment with a built-in faucet for ice drainage behind its easy-open door

### Six★Star™ Food Bars

- Molded with thick polyurethane foam for hours of insulation
- Use with ice or with Coldmaster® Standard Food Pans to keep food at 40°F or below for up to eight hours
- Two-piece acrylic shields allow for easy assembly
- Textured finish resists scratching and is simple to clean
- Faucet-type drain plug facilitates water removal
- Add tray slides and end shelves without removing legs
- Sturdy, recessed 5" non-marking swivel casters, two with brakes
- Easy to assemble
- Replacements parts shown on pages 299 & 300
- NSF Listed



6611 with 6621 Tray Slide

### Six★Star™ Portable Enclosed Bars

- 6 foot unit with enclosed storage unit and sliding doors



6605 with 6620 Tray Slide



6608 with 6621 Tray Slide and 6625 End Shelf



6601

### Six★Star™ Portable Food Bars

- Legs only unit available in 4 or 6 foot models

### Six★Star™ Youth Bar

- Low 29" serving height is designed for young people to conveniently reach all condiments

### Six★Star™ Tabletop Bars

- Threaded drain plug underneath ice pan for easy water removal



Brown(01)



Black(03)



Red(05)



Forrest Green(08)



Slate(59)

Prod No	Description	Color	Pack	Cs Wt/Cube
<b>Maximizer Food Bar &amp; Accessories</b>				
7711 Δ	6 ft Maximizer Food Bar	01, 03, 08, 59	1 ea	320.00/100.06
7721 Δ	6 ft Maximizer Tray Slide	01, 03, 08, 59	1 ea	14.75/1.14
7725 Δ	Maximizer End Shelf	01, 03, 08, 59	1 ea	11.35/0.79
<b>Six★Star Food Bars &amp; Accessories</b>				
6600 Δ	4 ft Six★Star Tabletop	01, 03, 05, 08	1 ea	63.00/12.16
6601 Δ	6 ft Six★Star Tabletop	03, 08	1 ea	92.00/18.01
6605 Δ	4 ft Six★Star Portable with Legs only	01, 03, 08	1 ea	120.00/17.32
6606 Δ	6 ft Six★Star Portable with Legs only	01, 03, 08	1 ea	142.00/27.28
6611 Δ	6 ft Six★Star Portable with Storage & Legs	03, 08	1 ea	170.00/61.68
6608 Δ	6 ft Six★Star Youth with Legs only	03, 05, 08	1 ea	135.00/27.28
6620 Δ	4 ft Six★Star Tray Slide (fits 6605)	01, 03, 08	1 ea	14.10/0.74
6621 Δ	6 ft Six★Star Tray Slide (fits 6606, 6608, 6611)	01, 03, 05, 08	1 ea	14.75/1.13
6625 Δ	Six★Star End Shelf (fits all Six★Star Food Bars)	01, 03, 05, 08	1 ea	11.75/0.66

NSF Listed products are designated with a Δ

Note: 6621 can ship UPS/FedEx Ground at oversize cost; 6600, 6601, 6608, 6611, 6605, 6606 cannot ship UPS/FedEx Ground

Note: 6600, 6601 tabletop units cannot be converted to portable units

# FOOD BARS & ACCESSORIES

## Five★Star™ Buffet Bars

- Thick polyurethane foam insulation holds ice for hours
- Great with crocks, bowls or icing down beverages
- Drain plug at end of unit
- NSF Listed



7670 with 9720 Sneeze Guard

## Sneeze Guards

- Designed to fit Five★Star Buffet Bars
- 9148, 9160, 9172 are NSF Listed



9260



9148



0588

## Electric Kettle

- Economical kettle includes 10.5 quart metal inset with hinged lid and ladle
- Thermostatically controlled warmer has low to high temperature settings
- 120 volt/450 watt; 6 foot detachable cord with 3-prong plug; insulating polypropylene shell
- Unit recommended for wet use
- NSF Listed; UL listed



## Cash 'N Carry

Selected products also available in a cash 'n carry pack. See page 277.



## Pastry Display Cases

- Display pies, cookies, and cakes
- Slide-in trays are textured to resist scratching
- Made of sanitary, easy-to-clean acrylic
- Convenient hinged door with magnetic closure



SPD303KD



Replacement Parts shown on pages 299 & 300

Prod No	Description	Color	Pack	Cs Wt/Cube
<b>Five★Star Buffet Bars</b>				
7670 <span style="color: green;">Δ</span>	4 ft Five★Star Buffet Bar	01, 03, 08	1 ea	21.10/4.49
7671 <span style="color: green;">Δ</span>	6 ft Five★Star Buffet Bar	01, 03	1 ea	32.83/6.88
<b>Free Standing Single-Sided Sneeze Guards</b>				
9148 <span style="color: green;">Δ</span>	48" Standard Single-Sided	03, 07	1 ea	19.00/3.00
9160 <span style="color: green;">Δ</span>	60" Standard Single-Sided	03, 07	1 ea	24.44/4.33
9172 <span style="color: green;">Δ</span>	73.25" Standard Single-Sided	03, 07	1 ea	27.50/4.65
9224	24" Adjustable Single-Sided	03, 07	1 ea	10.60/1.76
9248	48" Adjustable Single-Sided	03, 07	1 ea	19.25/2.99
9260	60" Adjustable Single-Sided	03, 07	1 ea	25.29/4.33
9272	73.25" Adjustable Single-Sided	03, 07	1 ea	29.05/4.58
<b>Free Standing Double-Sided Sneeze Guards</b>				
9710	48" Standard Double-Sided	03	1 ea	27.30/3.54
9712	73.25" Standard Double-Sided	03	1 ea	40.50/5.20
9720	48" Adjustable Double-Sided	03	1 ea	28.07/3.58
9722	73.25" Adjustable Double-Sided	03	1 ea	40.60/5.46
<b>Sneeze Guard Accessories</b>				
9051	Single End Panel (encloses side area on Single Sneeze Guard)	03	1 pr	2.07/0.27
9052	Double End Panel (encloses side on Double-Sided Sneeze Guard)	03	1 ea	2.10/0.27
<b>Electric Kettle</b>				
0588 <span style="color: green;">Δ</span> <span style="color: green;">C</span>	Electric Kettle with Inset, Lid & Ladle	03	1 ea	17.19/2.81
<b>Pastry Display Cases</b>				
SPD300	Three Tray (Back Door)	—	1 ea	21.00/5.55
SPD300KD	Three Tray (Back Door) (unassembled)	—	1 ea	25.90/1.91
SPD303	Three Tray, Self Serve Front & Back Door	—	1 ea	21.05/5.25
SPD303KD	Three Tray, Self Serve Front & Back Door (unassembled)	—	1 ea	24.60/1.91
SPD123	Tray Only	—	1 ea	1.90/0.33

NSF Listed products are designated with a Δ

**Cash 'N Carry products are designated with a C**

Sneeze guards not recommended for use with steam tables

Shipping Notes: 7671 cannot be shipped UPS/FedEx Ground; 7670 can ship at oversize cost  
 9160, 9172, 9260, 9416, 9722, 9712 cannot be shipped UPS/FedEx Ground; 9148, 9248, 9710, 9720, 9404,  
 9414 can ship at oversize cost  
 Pastry Display Cases listed above can be shipped UPS/FedEx Ground at oversize cost with the exception of  
 SPD123 shipping at standard rate

# CONDIMENT SOLUTIONS

## Packet Racks

- Packet Racks hold all types of condiment packets, utensils, straws, napkins and take up very little counter space
- Choose between a sturdy aluminum frame or an economical chrome wire frame
- Durable plastic containers have a drop-in card holder molded into the front
- Unit comes with a set of 31 common label cards for organizing and identifying contents
- For use on counter, or mount to wall with screws (included)



381109LG



381206LG

## Food Stations

### Condiment Food Station

- 10806 Condiment Station includes (4) sixth-size 6" deep, Top Notch® polycarbonate black food pans
- Can also hold (4) sixth-size Coldmaster® standard food pans sold separately on pages 92 & 93

### Multi-Purpose Food Station

- 10807 Multi-Purpose Station includes (4) third-size 4" deep, Top Notch® polycarbonate black food pans
- Can also hold (4) third-size Coldmaster® standard food pans sold separately on pages 92 & 93



10806

10807

Replacement Parts shown on page 301



38310

## Standard Pump Kit

- 38310 Includes Standard Pump and the following 5 lid sizes: 1.5", 4.31", 4.31"SP, 4.69", & 6.31"
- Pump and lid sets screw or snap on allowing you to pump condiments directly from their containers
- Standard Plastic Pump has 2 restrictor clips for dispensing either .5 or 1 ounce portions



### Cash 'N Carry

Selected products also available in a cash 'n carry pack. See page 278.

Carlisle topping rails, made of long lasting stainless steel, are perfect for dispensing condiments, dressings and sauces.

### Standard Topping Rails

- Economical Standard Plastic Pump comes with 2 restrictor clips for dispenses either .5 or 1 ounce portions
- Removable pumps and jars included
- Rubber feet protect counter and slipping



### Insulated Topping Rails

- Insulated unit combines with reusable ice packs to keep condiments chilled for hours.
- Includes reusable ice packs, 2 quart containers, pumps and self-adhesive labels of most popular condiments
- 2 quart containers include snap-on lids for overnight storage
- Choose between patented\* Stainless Steel Pump or economical Standard Pump
- Stainless Steel Pump dispenses 1.25 ounces per stroke; Standard Pump dispenses .5 or 1 ounce portions



### High Volume Condiment Pump

- Holds gallon jars or #10 cans for clean look
- Choose between patented\* Stainless Steel Pump or Fixed Nozzle Pump
- Stainless Steel Pump dispenses 1.25 ounce per stroke; Standard Pump dispenses .5 or 1 ounce portions



Black(03)

Prod No	Description	Color	Pack	Cs Wt/Cube
<b>Packet Racks</b>				
381109LG	Aluminum Packet Rack, comes with 9 ea 3.5 qt containers	—	1 ea	12.50/2.74
381206LG	Wire Packet Rack, comes with 6 ea 4 qt containers	—	1 ea	7.50/1.35
<b>Food Stations</b>				
10806	Condiment Food Station	03	1 ea	13.30/4.54
10807	Multi-Purpose Food Station	03	1 ea	16.40/4.45
<b>Standard Pump Kit</b>				
38310 <b>C</b>	Standard Pump Kit	—	6 ea	2.90/0.39
<b>Standard Pump Topping Rails</b>				
38502	Topping Rail with 2 ea Standard Pumps & Jars	—	1 ea	8.05/0.77
38503	Topping Rail with 3 ea Standard Pumps & Jars	—	1 ea	7.50/1.14
38504	Topping Rail with 4 ea Standard Pumps & Jars	—	1 ea	9.65/1.65
<b>Insulated Topping Rails</b>				
386230IB	Insulated Topping Rail with 3 ea Stainless Steel Pumps & 2 Large Ice Packs	—	1 ea	14.95/1.50
38623IB	Insulated Topping Rail with 3 ea Standard Pumps & 2 Large Ice Packs	—	1 ea	12.10/0.90
<b>High Volume Condiment Pumps</b>				
386010	High Volume Condiment Pump with Stainless Steel Pump	—	1 ea	6.15/0.80
38601	High Volume Condiment Pump with Fixed Nozzle Pump	—	1 ea	4.65/0.63

Cash 'N Carry products are designated with a **C**

\*US Patent Nos. 6343720, 6019256, 6450373



# CUP & LID DISPENSERS

## Adjustable Cup Dispensers

- One dispenser to fit all standard sizes of foam, paper, or plastic drink cups from 8 to 48 ounces
- Vertical Cabinet Models are made of rugged stainless steel
- Spring-loaded units with silicone release gaskets
- Comes with four interchangeable gaskets per tube (small, medium, large, and extra large)
- No tools required; ready to use



38882G

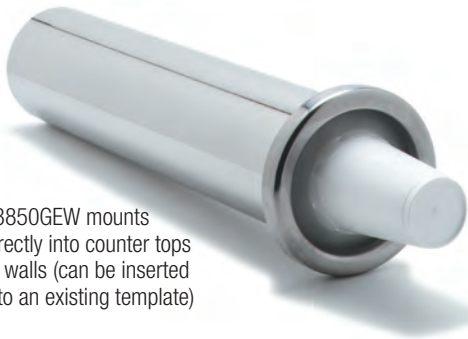

38850GEW mounts directly into counter tops or walls (can be inserted into an existing template)

38800GLC



38883G

38884G



## Gravity Feed Cup Dispensers

- Adjusts easily to fit various sizes of foam, paper, or plastic cups
- Mounts on walls and includes 2-piece quick-release side mount bracket

38820C



38830C



Replacement Parts shown on page 300





38800GLC

### Lid & Condiment Organizer

- Stainless Steel Organizer mounts on top of Vertical Cup Dispenser Cabinets or can be used on counter tops
- Rubber feet prevent slipping and protect counter
- Includes (2) pint & (3) quart plastic inserts



388804L

### Counter Top Lid & Straw Dispenser

- Dividers adjust to accommodate all standard size lids
- Straw panel is removable for additional lid storage
- Rubber feet protect counter tops
- Dispenser can be wall mounted on two standard key-lock holes



10828

### 6-Compartment Condiment Caddy

- Compact 8" x 14" size fits counter tops and coffee cabinets with limited space
- Stepped design with deep compartments for organizing condiments
- Durable ABS plastic with textured finish hides scratches



Black(03)



Clear(07)



TP100

SSD100

### Dispensers

- Sliding tops for easy loading

#### Toothpick Dispenser

- Holds standard box of toothpicks
- Security cable prevents theft

#### Straw Dispenser

- Holds a full box of regular or jumbo unwrapped straws up to 8.5" long
- Easy turn knob dispenses one straw at a time

Prod No	Description	Color	Pack	Cs Wt/Cube
<b>Adjustable Cup Dispensers</b>				
38882G	2 Cup Dispenser, Vertical Cabinet Model	—	1 ea	20.75/2.58
38883G	3 Cup Dispenser, Vertical Cabinet Model	—	1 ea	30.45/3.90
38884G	4 Cup Dispenser, Vertical Cabinet Model	—	1 ea	39.05/5.05
38850GEW	Cup Dispenser only	—	1 ea	5.10/1.10
<b>Gravity Feed Cup Dispensers</b>				
38820C	Small Cup Dispenser, holds 6-11 oz, 2.5 - 3.44" cups	—	1 ea	2.10/0.20
38830C	Large Cup Dispenser, holds 12-24 oz, 3.38" - 3.88" cups	—	1 ea	2.55/0.25
<b>Lid &amp; Condiment Organizer</b>				
38800GLC	Lid/Condiment Organizer	—	1 ea	5.30/1.10
<b>Counter Top Lid &amp; Straw Dispenser</b>				
388804L	4 Station Counter Dispenser	—	1 ea	3.30/0.58
<b>6-Compartment Condiment Caddy</b>				
10828	6-Compartment Coffee Service Condiment Caddy	03	12 ea	6.90/1.66
<b>Dispensers</b>				
TP100	Toothpick Dispenser	07	1 ea	0.84/0.07
SSD100	Straw Dispenser	07	1 ea	2.50/0.30

# BEVERAGE SERVICE

## TrimLine™ Rectangular Beverage Dispensers

- Sleek rectangular design saves valuable counter space
- Quart and liter capacity indicators on both sides
- Reservoir has ergonomic handles for a secure grip
- Features textured lid and base
- Hingeless lid minimizes breakage and helps prevent spills
- Removable Drip Tray prevents spills and saves on clean-up time
- Choose super tough crystal clear polycarbonate or economical translucent polypropylene
- Premium Dispenser has deluxe, no-drip, locking faucet
- Economy Dispenser has industry standard, no-drip faucet
- Includes labels: Fruit Punch, Iced Tea, Lemonade, Sweetened Tea, and Unsweetened Tea



10857

10850



2229

10820



## Square Beverage Dispenser

- Spring action faucet provides fast flow and driplless service

## Round Beverage Dispensers

- Embossed measuring lines in 1-quart increments
- Dispensers and base sold as a unit or dispenser sold separately
- Includes labels for Iced Tea, Lemonade, Fruit Punch, Sweetened and Unsweetened Tea

Replacement Parts shown on page 300

Prod No	Description	Color	Pack	Cs Wt/Cube
<b>TrimLine Single Base – Compact 8" width (Includes 1 ea 3 gal dispenser)</b>				
10850 $\Delta$	3 gal Premium (PC) Single Base	03, 69	1 ea	6.30/2.74
10854 $\Delta$	3 gal Premium (PPY) Single Base	03, 69	1 ea	5.85/2.74
10852 $\Delta$	3 gal Economy (PC) Single Base	03	1 ea	6.30/2.74
10856 $\Delta$	3 gal Economy (PPY) Single Base	03	1 ea	5.85/2.74
<b>TrimLine Double Base – Compact 15.5" width (Includes 2 ea 3 gal dispensers)</b>				
10851 $\Delta$	3 gal Premium (PC) Double Base	03	1 ea	11.50/4.03
10853 $\Delta$	3 gal Economy (PC) Double Base	03	1 ea	11.50/4.82
10857 $\Delta$	3 gal Economy (PPY) Double Base	03	1 ea	10.20/4.82
<b>Square Beverage Dispenser</b>				
10820	3 gal Square (Translucent PPY) Dispenser with Base	03	1 ea	4.65/1.03
<b>Round Beverage Dispensers With Base</b>				
2230	5 gal Round (White PE) Dispenser with Base	01	1 ea	4.65/1.59
2229	5 gal Round (Translucent PPY) Dispenser with Base	01, 03	1 ea	4.70/1.61
2227	3 gal Round (Translucent PPY) Dispenser with Base	01	1 ea	4.25/1.06
<b>Round Beverage Dispensers</b>				
2210	5 gal Round (White PE) Dispenser	02	1 ea	3.45/1.65
2220	3 gal Round (White PE) Dispenser	02	1 ea	2.65/1.06
2209	5 gal Round (Translucent PPY) Dispenser	30	1 ea	3.45/1.65
2219	3 gal Round (Translucent PPY) Dispenser	30	1 ea	2.65/1.06

NSF Listed products are designated with a  $\Delta$



# BAR SUPPLIES

Carlisle's bar supplies puts everything your bartender needs right at their fingertips. Our efficient, time-saving Bar Essentials, Store 'N Pour containers and caddy systems make Carlisle the only company you need for all your bar supplies.

<b>Product</b>	<b>Page</b>
Acrylic Ice Buckets . . . . .	120
Bar Caddy . . . . .	114
Bar Essential Bar Accessories . . . . .	118
Bar Mat & Service Mat . . . . .	115
Bar & Shelf Liner . . . . .	115
Cocktail Shakers . . . . .	118
Condiment Caddies	
Deluxe Condiment Caddy . . . . .	114
Plastic Condiment Caddy . . . . .	114
Stainless Steel Condiment Caddies . . . . .	114
Free Flowing Metal Liquor Pourers . . . . .	116
Glass Rimmers . . . . .	116
Ice Buckets . . . . .	120
Maximizer Portable Bar . . . . .	110 & 111
Maximizer Portable Bar Cover . . . . .	111
Money Maid Combo Packs . . . . .	117
Portion Control Liquor Pourers . . . . .	116

<b>Product</b>	<b>Page</b>
Poura-Clean Liquor Pourer Cleaning System . . . . .	116
Pour Free . . . . .	116
PourPlus . . . . .	113
Red Wine Holder . . . . .	118
Scoops . . . . .	120
Stainless Steel Speed-Rak Bottle Holders . . . . .	114
Store 'N Pour . . . . .	112
Store 'N Pour Bar Service Pack . . . . .	112
Store 'N Pour Complete Units & Backups . . . . .	113
Store 'N Pour Condiment System . . . . .	114
Store 'N Pour Versatility . . . . .	112
The Essential Drink Mix System . . . . .	112
Tip Trays . . . . .	117
Wine Buckets & Stands . . . . .	119
Wine Servers . . . . .	118
Wine Servers & Coolers . . . . .	118

# MAXIMIZER™ PORTABLE BAR



Maximizer Portable Bar's upscale styling is at home in any setting

Ergonomic 2-step bar and countertop is designed for ease of drink preparation and serving; large surface area keeps condiment caddies within reach without blocking the prep area.



7550



Built in cutting board for easy condiment preparation; can be removed for thorough cleaning.



Storage compartment includes molded-in rails; use with StorPlus™ 12" x 18" Food Storage Boxes.



Includes standard 22" Stainless Steel Speed-Rak™; holds 6 bottles or 6 Store 'N Pour® Quart containers.



Unique sliding storage drawer accommodates mixers, sodas, or standard bus boxes and can be removed for more versatile storage.



Large storage area under the drawer is perfect for staging glassware using our OptiClean™ Glass Racks.





See our money saving coupon online at [www.carlislefsp.com/ecoupons](http://www.carlislefsp.com/ecoupons)

### Maximizer Portable Bar

- Maximizer's sleek design blends easily with any foodservice environment, from banquet rooms to hotel lobbies, poolside and terrace dining
- Maximizer offers all the style and features you expect in a premium bar at a very affordable price
- Large 56" serving area keeps condiment caddies within reach without blocking prep area
- Durable solid molded countertop is easy to clean and includes a convenient molded-in bar mat well
- Sturdy 5" non-marking swivel casters with locking brake on each end hold the bar securely in place during use
- 15-gallon ice bin features an integrated drain and water trap
- Ice bin Includes a standard dust cover for sanitary storage and transport
- Fully assembled, no tools necessary
- Replacement parts are listed on page 302

### Maximizer Cover

- Protective 8 gauge vinyl cover keeps bar clean and dry when not in use
- Double vented back secures with hook and loop tape for a custom fit
- Tape fastening allows easy access to bar storage area without removing cover



Durable Maximizer Portable Bar is perfect for outdoor service



7555 Protective vinyl cover keeps bar clean and dry when not in use



Vented back for easy access



Black(03) Stainless Steel(44) Taupe(80) Cherry Wood(094)

Prod No	Description	Color	Pack	Cs Wt/Cube
<b>Maximizer Portable Bar &amp; Cover</b>				
7550	Maximizer Portable Bar	03, 44, 094	1 ea	160.00/46.05
7555 ▼	Maximizer Bar Cover	80	1 ea	10.00/0.35

Note: 7550 cannot ship UPS/FedEx Ground

**WARNING:** Products identified on this page with the following symbol ▼ contain chemicals, including one or more phthalates, known to the State of California to cause cancer and birth defects and other reproductive harm.

# STORE 'N POUR®

## Store 'N Pour

- Enjoy the benefits of the most efficient storing and pouring system for the bar, kitchen, or dining room
- Pour a perfect 2-1 drink every time with the patented vented spout design
- Two-piece spout and neck design for easy cleaning
- Exclusive manufacturing process ensures tight seal with no leaks
- Made of high density, break-resistant polyethylene
- Easy clean containers have straight wall design with no sharp interior edges that can collect food or bacteria
- Unique stacking ridge on quart and pint caps make storage on shelf in refrigerator easy and secure
- Color-coordinated spouts and caps for easy product identification

## Store 'N Pour Bar Service Pack

- Includes six quart complete units (container, neck, and color-coordinated spout and cap), 18-quart backup units (container and cap) and 1-gallon backup unit (container with cap) for mixing



PS6012

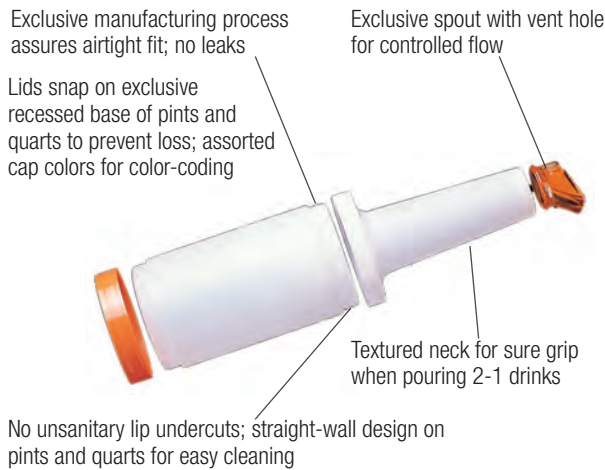

**Cash 'N Carry**  
 Selected products also available in a cash 'n carry pack. See page 278.

## Store 'N Pour Versatility



Front-of-the-house use



Perfect 2-1 drinks are easy



Stackable backup storage



Back-of-the-house use



Pour batters and oils

## The Essential Drink Mix System



**1. Mix In One-Gallon Container**  
 Accurately measure and mix concentrate or powder in gallon containers. Its wide mouth eliminates the need for a funnel.



**2. Cut Preparation Time**  
 Prepare mixes and juices in advance using the gallon storage container. At peak periods simply empty into a quart backup.



**3. Transfer To Quarts**  
 Pour a gallon of mix into four easy-to-handle quart containers.



**4. Ready To Use**  
 Attach neck with spout to one quart for use in speed rack. Cap the remaining three quarts for backup.

## Store 'N Pour Complete Units & Backups

- Complete unit includes neck and container plus color-coordinated pouring spout and cap
- Backup unit includes cap and container
- Dishwasher safe

### Store 'N Pour Speed Spout

- No-drip spout is vented to promote faster, more even flow

## PourPlus™

### PourPlus Complete

- Complete unit includes container, lid, and spout

### PourPlus Spout

- PourPlus fits all Store 'N Pour containers
- Integrated neck and spout designed for fast free flowing pouring and easy clean-up
- Textured neck provides sure grip - even when wet
- Necks are color-coded



Replacement Parts shown on page 302

Prod No	Description	Color	Pack	Cs Wt/Cube
<b>Store 'N Pour Bar Service Pack</b>				
PS6012	Store 'N Pour Bar Service Pack	00	1 set	6.95/1.83
<b>Store 'N Pour Complete Units &amp; Backups</b>				
PS501N	Pint Complete	00	12 ea	3.50/0.88
PS502N	Pint Backup	00	12 ea	1.96/0.64
PS601N <b>C</b>	Quart Complete	00, 01, 02, 04, 05, 09, 24	12 ea	4.60/0.89
PS602N	Quart Backup	00, 02, 05	12 ea	3.20/0.82
PS701B	Half-gallon Complete	00	6 ea	2.90/0.90
PS702	Half-gallon Backup	00	6 ea	2.05/0.88
PS801B	Gallon Complete	00	6 ea	4.00/1.87
PS802	Gallon Backup	00	6 ea	3.15/1.84
PS103	Spouts, Specify Color	01, 04, 05, 07, 24	12 ea	0.46/0.05
PS103AT	Spout Assortment, 2 ea color	00	12 ea	1.00/0.05
PS203	Necks	02	12 ea	1.60/0.30
PS304	Caps, Specify Color	01, 02, 04, 05, 24	12 ea	0.70/0.01
PS304AT	Caps, Assortment, 2 ea color	00	12 ea	0.70/0.01
PS603N	Quart, Container Only	02	12 ea	3.00/0.85
<b>Store 'N Pour Speed Spout</b>				
3042	Speed Spout	07	24 ea	0.55/0.05
<b>Pour Plus Store 'N Pour</b>				
PS204	PourPlus Spout	02	12 ea	1.60/0.30
PS204AST*	PourPlus Spout, Assorted	00	1 set	1.60/0.30
PS601NC	Quart Complete	00, 02	12 ea	4.60/0.89

Cash 'N Carry products are designated with a **C**

\*Assorted PourPlus quart packs include 2 each of all colors; half-gallon and gallon assorted packs includes 1 each of all colors

# CONDIMENT CADDIES & ACCESSORIES



38322BH  
Combine to make a double-hung unit

## Stainless Steel Speed-Rak™ Bottle Holders

- Keyhole slots make installation and cleaning easy
- Mounts to bar sink with screws (provided)
- Unique design; single Speed-Raks can be combined to make a double-hung unit



38704CSIB

## Stainless Steel Condiment Caddies

- Rugged stainless steel construction for years of use
- Rubber feet protect counter tops
- Full size hinged lid units protect condiments from spills and contaminants
- Individual compartment lids keep contents covered when not in use
- Notched lid models available for use with spoons or ladles
- Sanitary pint & quart inserts are easy to clean; (2) pints interchange with (1) quart, allowing you to mix and match to suit your needs



CH03

## Stainless Steel Iced Condiment Caddies

- Insulated caddies use ice packs to keep condiments chilled and cold for hours without ice or electricity



SS105

## Deluxe Condiment Caddy

- Solid frosted cover
- Includes caddy and individual containers

## Plastic Condiment Caddy

- Solid frosted cover
- Includes caddy and individual containers



BC05

## Bar Caddy

- Ideal bar-top holder that allows quick access to cocktail napkins, stirrers, and other accessories
- Break-resistant plastic



PS101CS

## Store 'N Pour® Condiment System

- Condiment system includes tray with cover and six pint containers (PS502N) with assorted caps
- Assorted color caps provide easy identification; caps snap on the bottom for easy storage
- Acrylic covers protect condiments during service



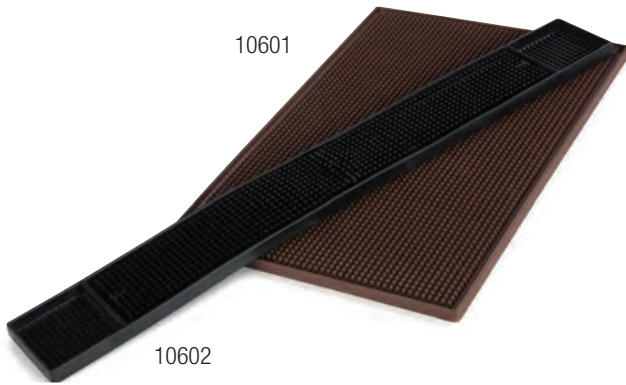

3210, 3211

### Bar Mat & Service Mat

- Non-slip mats help keep counter tops clean
- Molded-in pattern provides drainage for spilled drinks and wash downs with a sure grip for wet glassware
- Bar Mats have drainage area for jigger, main area holds up to six glasses

### Bar & Shelf Liner

- Provides skid-resistance and high impact absorption; net pattern allows thorough drainage, promoting rapid, fog-free drying
- Helps prevent bacteria growth
- Resistant to food acids, grease, and detergents; conforms to FDA regulations
- Constructed of a firm, resilient plastic



Replacement Parts shown on page 302

Prod No	Description	Color	Pack	Cs Wt/Cube
<b>Stainless Steel Speed-Rak Bottle Holders</b>				
38322BH	22" Speed-Rak, holds (5) 1-liter bottles	—	2 ea	8.50/1.09
38332BH	32" Speed-Rak, holds (8) 1-liter bottles	—	2 ea	11.75/1.77
38342BH	42" Speed-Rak, holds (10) 1-liter bottles	—	2 ea	12.00/1.79
<b>Stainless Steel Condiment Caddies</b>				
38704CNS	4 qt Condiment Caddies with 4 Lids	—	1 ea	4.60/0.60
38704CSIB	4 qt Condiment Caddies with 4 Notched Lids & 4 Ice Packs	—	1 ea	8.20/0.80
38704C	4 pt Condiment Caddies with One-Piece Lid	—	1 ea	2.50/0.32
38705C	5 pt Condiment Caddies with One-Piece Lid	—	1 ea	2.85/0.32
38706C	6 pt Condiment Caddies with One-Piece Lid	—	1 ea	3.20/0.32
<b>Plastic Condiment Caddies</b>				
SS105	Caddy with 5 ea 1.25 Pint Containers/Lids	02	1 ea	3.30/0.43
CH03	Deluxe Condiment Caddy with 6 ea Pint Containers	03	1 ea	3.25/0.31
CH15	Deluxe Condiment Caddy with 4 ea 1.5 Pint Containers	03	1 ea	3.25/0.31
<b>Bar Caddy</b>				
BC05	Bar Caddy	03	12 ea	16.53/1.84
<b>Store 'N Pour Condiment System</b>				
PS101CS	Complete Condiment System	00	2 ea	4.75/0.65
<b>Bar Mat &amp; Service Mat</b>				
10601	12" x 18" Service Mat	01, 03	6 ea	9.70/0.69
10602	3" x 27" Bar Mat	01, 03	12 ea	10.00/0.44
<b>Bar &amp; Shelf Liner</b>				
3210	2' x 40' Texliner Roll	01, 03, 07	1 ea	9.50/0.95
3211	2' x 10' Texliner Roll	03, 07	1 ea	2.35/0.45

# BAR ACCESSORIES



## Glass Rimmers

### Standard Glass Rimmer

- Two-tier unit provides consistent and even coat of salt

### Combination Salt/Sugar Glass Rimmer

- Three-tier unit allows for application of either salt or sugar



### Cash 'N Carry

Selected products also available in a cash 'n carry pack. See page 278.



## Portion Control Liquor Pourers

- Carlisle offers portion control pourers in both ounce and metric measurements
- Classic design Portion Pour dispenses exact shots of liquor

### Portion Pour®

- Portion Pour dispenses exact shots of liquor from 1 to 1.5 ounce
- Also available in 20ml metric size



OP371, OP304

## Pour Free®

- Economical Pour Free for free-flow pouring



## Free Flowing Metal Liquor Pourers

- Sturdy metal construction and choice of three flow rates
- Chrome plated for attractive appearance and longer life

### Pourer With Screen

- Metal style pourer with sanitary screen



11000

## Poura-Clean™ Liquor Purer Cleaning System

- Patent pending pressurized pump system cleans pourers quickly and thoroughly; reduces contamination, liquor loss, labor, and replacement costs
- Cleans a dozen pourers in a matter of seconds



### Tip Trays

- Standard Tip Tray and Check Holder are made of styrene
- Check Holder's handy clip keeps checks, credit cards, or cash securely in place
- NSF Listed; dishwasher safe



Standard(00)    Brown(01)    Black(03)    Chrome(38)

### Money Maid™ Combo Packs

- Contains a locking coin and bill compartment, napkin holder, and utility pocket; designed to clip onto trays; see our line of Griptite, GripLite and Cork Trays shown on pages 126 & 127
- Combo Packs include one Money Maid and six coin trays in a shrink-wrapped set
- Round Clip-On (1401) fits all standard 14" round trays
- Rectangular Clip-On (1030) and Coin Trays fit all 12" x 16" trays

Prod No	Description	Color	Pack	Cs Wt/Cube
<b>Glass Rimmers</b>				
GR09	3-Tier Glass Rimmer	03	12 ea	15.00/1.07
GR10	2-Tier Glass Rimmer	03	12 ea	16.53/1.84
<b>Portion Control Liquor Pourers With Red Spout/Black Collar</b>				
EP214	1 oz Portion Pour with Red Base	00	12 ea	0.67/0.07
EP215	1.13 oz Portion Pour with Purple Base	00	12 ea	0.67/0.07
EP216	1.25 Portion Pour with Clear Base	00	12 ea	0.67/0.07
EP217	1.5 oz Portion Pour with Yellow Base	00	12 ea	0.67/0.07
<b>Metric Portion Control Liquor Pouter With Red Spout/Black Collar</b>				
EP320	20 ml Portion Pour with Black Base	00	12 ea	0.67/0.07
<b>Pour Free</b>				
OP304	Sparkle Red Pour Free	00	12 ea	0.28/0.07
OP305	Fluorescent Red Pour Free	00	12 ea	0.28/0.07
OP311	Blue Pour Free	00	12 ea	0.28/0.07
OP314	Clear Pour Free	00	12 ea	0.28/0.07
OP316	Black Pour Free	00	12 ea	0.28/0.07
OP371	Chrome/Black Collar Pour Free	00	12 ea	0.28/0.07
OP373	Clear/Black Collar Pour Free	00	12 ea	0.28/0.07
<b>Metal Style Free Flowing Pourers</b>				
WPM25	Chrome Tapered with Screen	38	12 ea	0.35/0.03
WPM85	Chrome Tapered, Medium Flow	38	12 ea	0.35/0.03
WPM20	Chrome Straight, Fast Flow	38	12 ea	0.35/0.03
WPM45	Chrome Angled, Super Fast Flow	38	12 ea	0.35/0.03
<b>Poura-Clean</b>				
11000	Poura-Clean Pressurized Cleaning System (includes one removable tray)	03	1 ea	3.04/0.62
<b>Tip Trays</b>				
3022 <span style="color: blue;">Δ</span>	Standard Tip Tray; 4.5" x 6.5"	01, 03	36 ea	4.72/0.18
3020 <span style="color: blue;">Δ</span> <span style="color: blue;">C</span>	Check Holder Tip Tray; 4.38" x 7.75"	03	12 ea	1.80/0.14
<b>Money Maid Combo Packs</b>				
1401	Round Clip-On Money Maid	01	12 ea	5.94/0.77
1031	Round Money Maid Combo Pack with Six Coin Trays	01	12 ea	8.19/0.85
1030	Rectangular Money Maid Combo Pack with Six Coin Trays	01	12 ea	7.37/0.64

NSF Listed products are designated with a Δ

Cash 'N Carry products are designated with a C

# BAR ACCESSORIES

## Cocktail Shakers

- Bar Essential 18-8 mirror polished all stainless steel classic 3-piece shaker (608600) has a vented pour spout that reduces splashing and spills
- Units fit together snugly for no-mess shaking
- Stylish 18-10 stainless Astor shaker (608615) is perfect for classic cocktails; built-in pour lip eliminates runs and heavy gauge construction reduces heat transfer – helps keep drinks cold

## Bar Essential™ Bar Accessories

### Shaker

- Bar Essential 18-8 heavy-duty shaker (608530) features sturdy one-piece construction; ultra smooth interiors won't scratch or chip mix glasses

### Bar Spoon

- Heavy-duty bar spoon is perfect for hand mixing drinks
- 18-8 stainless steel won't rust like economy spoons
- NSF Listed; dishwasher safe



609143

609144

609145



IG224

IG222

## Wine Servers

- Wine Servers merchandise your wine selection
- Double-wall construction provides insulation, helps keep wine at proper temperatures

## Wine Servers & Coolers

### Double Walled Wine Coolers

- Double walled construction keeps bottles chilled for hours (no need to pre-chill cooler or use ice)
- Prevents damaging surface condensation
- 18-8 stainless steel is more durable than marble coolers; never requires polishing
- Choose satin or mirror polish finish
- 609144 and 609145 also accommodate champagne bottles
- Hand wash only



609106

## Red Wine Holder

- Satin finish 18-8 stainless steel never requires polishing
- Two rings orbit above the base to create an easy carry handle; bottles snap into handle for secure pouring
- Hand wash only



### Wine Buckets & Stands

- Wine buckets and stands enhance any fine dining experience
- Choice of standard or double size wine bucket
- Stands are 24" high with heavy, weighted bases to prevent accidental tipping
- 18-8 stainless steel never requires polishing
- Mirror polish finish, hand wash only



609107



609110

609146



609109

609147



Black(03)



Clear(07)

Prod No	Description	Color	Pack	Cs Wt/Cube
<b>Cocktail Shakers</b>				
608600	30 oz Classic Cocktail Shaker	—	12 ea	10.00/1.63
608615	24 oz Astor Cocktail Shaker	—	12 ea	10.00/0.94
<b>Bar Essential Bar Accessories</b>				
608530	30 oz Bar Essentials Bar Cup	—	12 ea	6.00/0.19
608212 $\Delta$	11.25" Heavy-Duty Bar Spoon	—	24 ea	2.65/0.08
<b>Double Walled Wine Servers &amp; Coolers</b>				
609143	Double Wall Wine Cooler, Satin Finish with Mirror Finish Rim; 7.75" H	—	1 ea	1.03/0.12
609144	Double Wall Wine Cooler, Satin Finish with Mirror Finish Rim; 8.75" H	—	1 ea	3.00/0.19
609145	Double Wall Wine Cooler, Mirror Finish, 8.75"H	—	3 ea	8.40/0.73
<b>Acrylic Wine Servers</b>				
IG222	Acrylic Server with Clear Base	03, 07	12 ea	18.30/1.92
IG224	Acrylic Server with Black Base	03, 07	12 ea	18.30/1.92
<b>Red Wine Holder</b>				
609106	Red Wine Holder	—	1 ea	1.30/0.20
<b>Wine Buckets &amp; Stands</b>				
609107	Wine Bucket (fits 609146)	—	1 ea	9.40/1.26
609109	Magnum Deluxe Wine Bucket (fits 609147)	—	1 ea	3.00/0.62
609110	Allegro Wine Bucket (fits 609146)	—	1 ea	3.00/0.31
609146	24" Wine Bucket Stand; 7.5" Dia	—	1 ea	11.00/0.65
609147	24" Wine Bucket Stand; 8.5" Dia	—	1 ea	11.00/0.67

NSF Listed products are designated with a  $\Delta$

# ICE BUCKETS & SCOOPS

## Ice Buckets

- 18-8 stainless steel never requires polishing
- Double walled construction (609190, 609193) holds ice longer and prevents surface condensation
- 609190 has flat handle, hinged lid and comes complete with perforated drain tray and tong
- 609191 has mirror polished finish outside, satin finish inside, with knob handles
- 609193 has tubular handle and satin finish; complete with lid
- Hand wash only



609190



609193



609191



IG245

IG1011

## Acrylic Ice Buckets

- Can also be used for chilling wine
- Diamond Cut Bucket has chrome-plated lid and side handles
- Wine/Ice Bucket has attractive pebbled finish in clear acrylic



606106

4306



Clear(07)



## Scoops

- 606106 scoop is made of 18-8 rust-free mirror polished stainless steel
- 6 ounce scoops are tapered for easy pouring of ice into glasses
- 4306 features a hole for hanging or tying to a container
- Made of durable polycarbonate material for long-lasting use
- See page 158 for a complete listing of Carlisle's scoop line
- NSF Listed; dishwasher safe

Prod No	Description	Color	Pack	Cs Wt/Cube
<b>Stainless Steel Ice Buckets</b>				
609190	1.5 qt Double Wall Ice Bucket with Tong	—	1 ea	4.00/0.20
609193	3.5 qt Double Wall Ice Bucket	—	1 ea	2.00/0.35
609191	1.7 qt Ice Bucket with Handle and Tong	—	1 ea	2.00/1.06
<b>Acrylic Ice Buckets</b>				
IG245	Diamond Cut Bucket with Handle	07	6 ea	16.50/2.50
IG1011	Wine/Ice Bucket with Handle	—	4 ea	3.90/0.92
<b>Scoops</b>				
606106 Δ	6 oz Stainless Steel Bar Scoop	—	24 ea	5.30/0.19
4306 Δ	6 oz Polycarbonate Scoop	07	12 ea	2.60/0.33

NSF Listed products are designated with a Δ



# FOODSERVICE TRAYS

Carlisle's trays and accessories are just what you need for an efficient foodservice buffet and bar service establishment. For size and color selection, light-weight durability and user stability, we make the trays that set the quality standard.

<b>Product</b>	<b>Page</b>
Bakery Trays .....	122
Bar Trays .....	126
Bistro Trays .....	124
Café Trays	
Handled Café Trays .....	125
Standard Café Trays .....	125
Trapezoid Café Trays .....	125
Celebration Trays .....	128
Compartment Trays	
4-Compartment Trays .....	132
5-Compartment Trays .....	132
6-Compartment Trays .....	130
Cork Trays .....	126
Display Trays .....	122, 128 & 129
Euronorm, Metric Trays .....	122
Festival Trays .....	129
Fiberglass Trays	
Fiberglass Market Pans .....	124
Fiberglass Market Trays .....	124
Glasteel Fiberglass Trays .....	122

<b>Product</b>	<b>Page</b>
GripLite Trays .....	126
Griptite Trays .....	126
Market Pans	
Fiberglass Market Pans .....	124
Market Trays	
Fiberglass Market Trays .....	124
Octagonal Trays .....	128
Oval Trays .....	128
Pastry Tray Covers .....	132
Polycarbonate Trays .....	124
Rectangular Trays .....	122 & 128
Round Trays .....	128
Room Service Trays .....	128
Round Heavy-Weight Tray .....	129
Serving Trays .....	128 & 129
Stainless Steel Trays .....	128 & 129
Trapezoid Trays .....	122
Tray Covers .....	132
Tray Stands .....	127

# FIBERGLASS TRAYS

## Glasteel™ Fiberglass Trays

- Engineered to be the most durable fiberglass trays available
- Decorating option, see page 296 for additional information
- NSF Listed; dishwasher safe

### Heavy-duty Glasteel Construction

- Metal reinforcing rods provide extra strength and eliminate warping
- Two thick reinforcing fiberglass core mats add strength and provide increased chemical resistance

### Air Flow Corner Reinforcements

- Air flow corner reinforcements and stacking lugs make Glasteel trays your best choice for stability and drying when stacked
- Unique design permits air flow to all surfaces of stacked trays, reducing drying time



## Available in a variety of colors, patterns, shapes and sizes

### Rectangular — Regular and Low-Edge

- Low-edge trays have “squared-off” corners to permit dish overhang, fitting more serving items on a given tray size

### Display/Bakery

- Ideal for displays and available in all colors and patterns

### Trapezoid

- Space saving shape for better table fit

### Euronorm/Metric Trays

- Accommodates Euronorm foodservice dimension standards

**Glasteel Fiberglass Tray  
5 Year Warranty**  
Carlisle FoodService Products warrants all of our Glasteel Fiberglass Trays for 5 years from the date of original purchase against breakage arising from normal use and service.

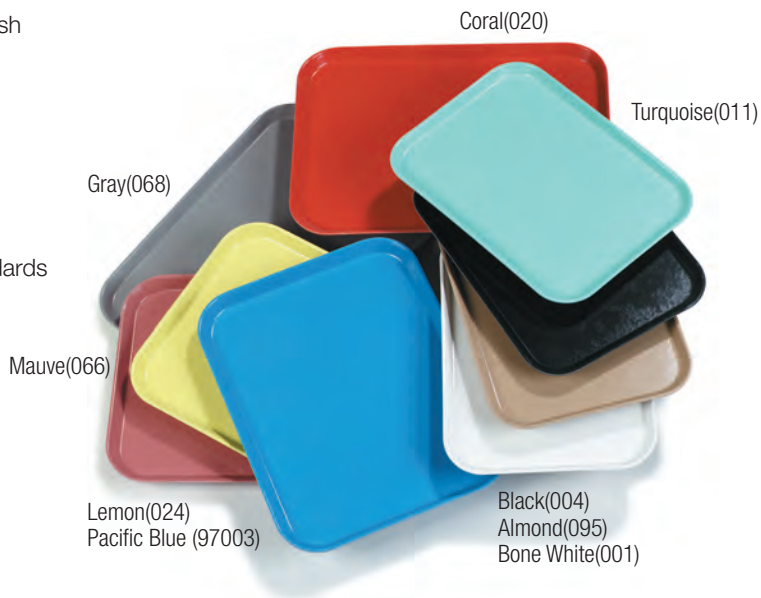

Rectangular — Regular



Rectangular — Low-Edge



Display/Bakery



Euronorm/Metric Trays



Trapezoid

Fiberglass Trays are available in full cases only.  
There is a NO-RETURN POLICY on Fiberglass Trays.



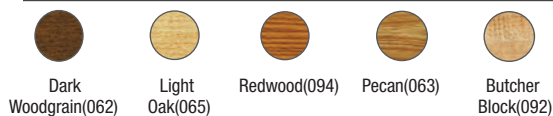
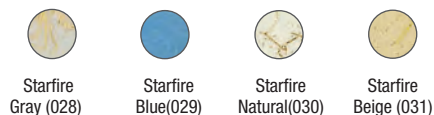
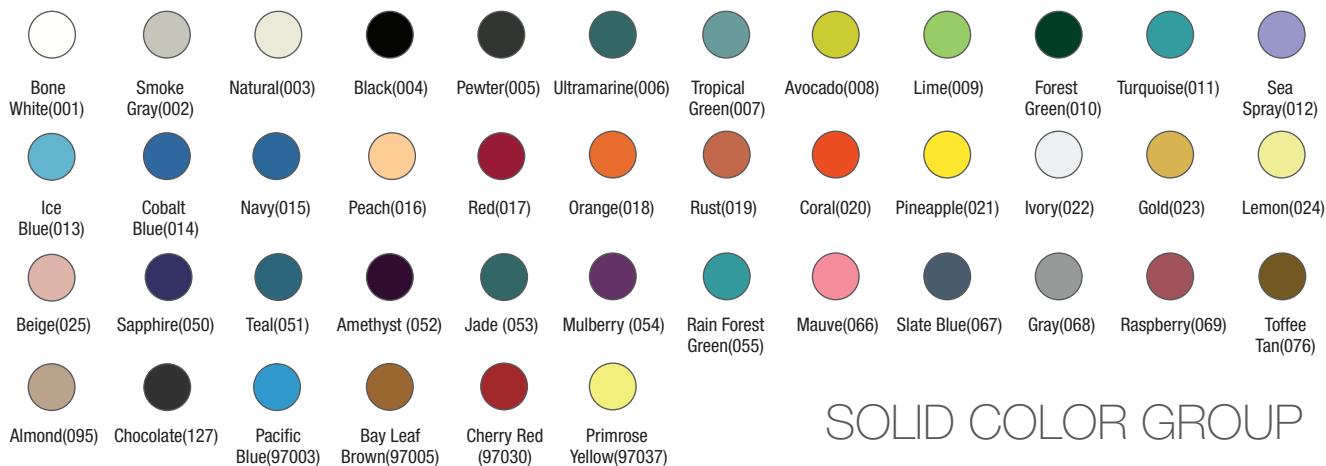

Prod No	Description	Pack	Cs Wt/Cube
<b>FG Solid Color    FG Decorative Pattern    FG Wood Grain</b>			
<b>Rectangular</b>			
1410FG <sup>Δ</sup>	1410DFG <sup>Δ</sup>	1410WFG <sup>Δ</sup>	13.75/10.62/0.75
1612FG <sup>Δ</sup>	1612DFG <sup>Δ</sup>	1612WFG <sup>Δ</sup>	16.37/12.00/0.75
1814FG <sup>Δ</sup>	1814DFG <sup>Δ</sup>	1814WFG <sup>Δ</sup>	18.00/14.00/0.75
2015FG <sup>Δ</sup>	2015DFG <sup>Δ</sup>	2015WFG <sup>Δ</sup>	20.25/15.00/0.75
2216FG <sup>Δ</sup>	2216DFG <sup>Δ</sup>	2216WFG <sup>Δ</sup>	22.12/16.00/1.05
<b>Low Edge</b>			
1216LFG <sup>Δ</sup>	1216LDFG <sup>Δ</sup>	1216LWFG <sup>Δ</sup>	16.37/12.00/0.62
1418LFG <sup>Δ</sup>	1418LDFG <sup>Δ</sup>	1418LWFG <sup>Δ</sup>	18.00/14.00/0.62
1219LFG <sup>Δ</sup>	1219LDFG <sup>Δ</sup>	1219LWFG <sup>Δ</sup>	19.00/12.00/0.62
1520LFG <sup>Δ</sup>	1520LDFG <sup>Δ</sup>	1520LWFG <sup>Δ</sup>	20.25/15.00/0.62
1222LFG <sup>Δ</sup>	1222LDFG <sup>Δ</sup>	1222LWFG <sup>Δ</sup>	21.06/12.06/0.80
<b>Display/Bakery</b>			
269FG <sup>Δ</sup>	269DFG <sup>Δ</sup>	269WFG <sup>Δ</sup>	8.75/25.50/1.12
1318FG <sup>Δ</sup>	1318DFG <sup>Δ</sup>	1318WFG <sup>Δ</sup>	17.75/12.75/1.00
2618FG <sup>Δ</sup>	2618DFG <sup>Δ</sup>	2618WFG <sup>Δ</sup>	17.87/25.62/1.25
<b>Trapezoid</b>			
1713FG <sup>Δ</sup>	1713DFG <sup>Δ</sup>	1713WFG <sup>Δ</sup>	18.00/14.00/0.85
2214FG <sup>Δ</sup>	2214DFG <sup>Δ</sup>	2214WFG <sup>Δ</sup>	22.00/14.06/0.88
<b>Euronorm</b>			
3753FG <sup>Δ</sup>	3753DFG <sup>Δ</sup>	3753WFG <sup>Δ</sup>	530mm/370mm/19mm
4523FG <sup>Δ</sup>	4523DFG <sup>Δ</sup>	4523WFG <sup>Δ</sup>	450mm/320mm/17mm
2637FG <sup>Δ</sup>	2637DFG <sup>Δ</sup>	2637WFG <sup>Δ</sup>	370mm/265mm/19mm
1826FG <sup>Δ</sup>	1826DFG <sup>Δ</sup>	1826WFG <sup>Δ</sup>	260mm/180mm/19mm
<b>Metric</b>			
2310FG <sup>Δ</sup>	2310DFG <sup>Δ</sup>	2310WFG <sup>Δ</sup>	589mm/238mm/16mm
1220FG <sup>Δ</sup>	1220DFG <sup>Δ</sup>	1220WFG <sup>Δ</sup>	530mm/325mm/16mm
1212FG <sup>Δ</sup>	1212DFG <sup>Δ</sup>	1212WFG <sup>Δ</sup>	325mm/265mm/16mm
2115FG <sup>Δ</sup>	2115DFG <sup>Δ</sup>	2115WFG <sup>Δ</sup>	530mm/375mm/16mm
1419FG <sup>Δ</sup>	1419DFG <sup>Δ</sup>	1419WFG <sup>Δ</sup>	500mm/385mm/16mm

NSF Listed products are designated with a <sup>Δ</sup>

To see corresponding covers, check out page 132 in this catalog section



# SPECIALTY TRAYS

## Fiberglass Market Trays And Pans



### Fiberglass Market Trays

- Use for displaying breads, bakery items, and sliced deli meat
- Trays have heavy-duty fiberglass construction and metal reinforced rods
- Air-flow corners reduce drying time
- NSF Listed



1032FMT

6302FMT



### Fiberglass Market Pans

- 2" deep pans for serving deli salads, pasta, and desserts
- Heavy-duty fiberglass construction with metal reinforced rims
- Air-flow corners reduce drying time
- NSF Listed



### Cash 'N Carry

Selected products also available in a cash 'n carry pack. See page 278.



1418PC

### Polycarbonate Tray

- Five-year warranty against breakage saves you money
- Designed for use in correctional facilities, schools, and other demanding foodservice applications
- Polycarbonate trays will not break or shatter and have a textured, scratch-resistant finish
- They provide rigidity and durability without metal reinforcement rods
- Resistant to food acids and oils and safe for use in temperatures of -40°F to 212°F
- NSF Listed; dishwasher safe

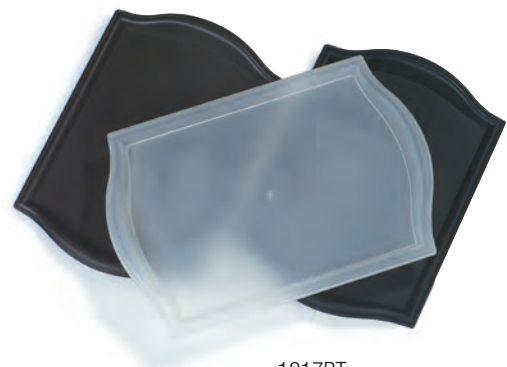

1217BT

### Bistro™ Trays

- Unique trays offer a great look at an economical price
- Offer the durability and economy of our Café Trays
- Stylish curved handles for easy handling and added strength
- Scratch-resistant, textured design reduces slipping, helps prevent spills
- Drying and stacking lugs

## Café Trays

- Economical & light-weight polypropylene
- Feature skid-resistant surface and drying/stacking lugs
- Custom hot stamping is available, see page 297 for additional information
- NSF Listed

### Standard Café Tray

- Traditional scratch-resistant basket weave design reduces slipping and helps prevent accidental spills

### Trapezoid Café Tray

- Space saving shape allows diners to eat directly from trays without removing plates, cups, etc. from the tray
- Promotes self-bussing

### Handled Café Tray

- Handled tray is easy to carry and offers added strength

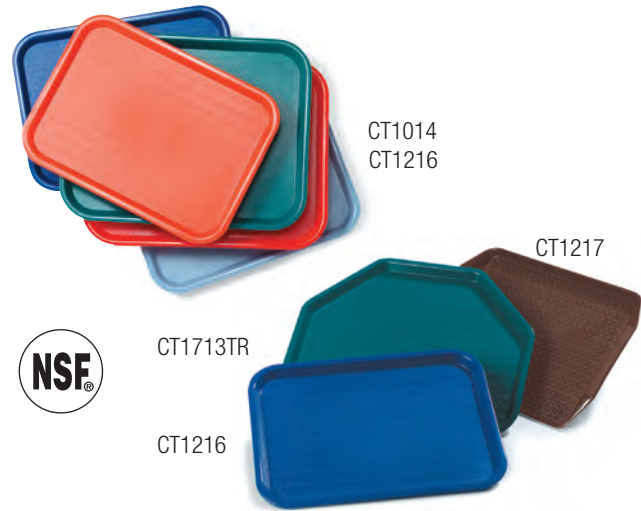

Carlisle recommends hand washing for Café Trays



Prod No	Description	Color	Pack	Cs Wt/Cube
<b>Fiberglass Market Trays</b>				
630FMT $\Delta$	30.00/6.44/0.75 Tray	302, 303, 304	12 ea	16.40/0.63
830FMT $\Delta$	30.00/8.50/0.75 Tray	301, 302, 303, 304, 306, 309	12 ea	20.00/0.82
1030FMT $\Delta$	30.00/10.44/0.75 Tray	301, 302, 303, 304, 306, 309	12 ea	24.90/1.01
1230FMT $\Delta$	30.00/12.44/1.05 Tray	301, 303, 304, 309	12 ea	27.00/1.13
269FMT $\Delta$	8.75/25.50/1.12 Tray	301, 309	12 ea	19.75/0.81
1218FMT $\Delta$	17.75/11.44/0.75 Tray	301, 303, 309	12 ea	14.26/0.64
1318FMT $\Delta$	17.75/12.75/1.00 Tray	301, 309	12 ea	19.50/0.64
2618FMT $\Delta$	17.87/25.62/1.25 Tray	301, 302, 303, 304, 306, 309	12 ea	40.50/1.65
<b>Fiberglass Market Pans</b>				
6302FMT $\Delta$	30.00/6.45/2.00 Pan	301, 309	12 ea	20.50/0.75
8302FMT $\Delta$	30.00/8.45/2.00 Pan	301, 309	12 ea	25.25/0.90
10302FMT $\Delta$	30.00/10.47/2.00 Pan	301, 304, 309	12 ea	29.20/1.20
10302FMT $\Delta$	30.00/10.47/2.00 Pan	301, 304, 309	12 ea	29.20/1.20
<b>Polycarbonate Trays</b>				
1418PC $\Delta$	18.00/14.00/1.13 Rectangular Tray	25	12 ea	16.15/0.71
<b>Bistro Trays</b>				
1217BT	12" x 17" Bistro Tray	03, 30	12 ea	11.02/0.73
1319BT	13" x 19" Bistro Tray	03, 30	12 ea	13.01/0.64
<b>Café Trays</b>				
CT1014 $\Delta$ <b>C</b>	13.87/10.75/0.79 Standard Tray	03, 05, 06, 08, 09, 14, 15, 23, 24, 59, 61, 69	24 ea	10.95/0.52
CT1216 $\Delta$ <b>C</b>	16.31/12.06/0.70 Standard Tray	03, 05, 06, 08, 09, 14, 15, 21, 23, 24, 31, 59, 61, 69	24 ea	19.00/0.80
CT1418 $\Delta$ <b>C</b>	17.87/14.00/0.98 Standard Tray	03, 05, 06, 08, 09, 14, 15, 23, 24, 31, 56, 59, 61, 69	12 ea	12.50/0.61
CT1713TR $\Delta$	18.00/14.00/0.81 Trapezoid Tray	03, 06, 08, 09, 14, 23, 31, 61, 69	12 ea	11.26/0.57
CT1217 $\Delta$	16.93/12.06/0.60 Handled Tray	03, 05, 14, 24, 69	24 ea	19.10/1.08

NSF Listed products are designated with a  $\Delta$   
Cash 'N Carry products are designated with a **C**

# SERVICE TRAYS

## Griptite™ Trays

- Rubber liner prevents slipping and sliding of glass and dinnerware
- Heavy-duty construction with metal reinforcement rods eliminate warping
- Rubber liner is permanently bonded to the tray and covers side wall and tray top to provide extra grip
- The 31" oval size helps reduce labor costs by serving an entire banquet table of eight with just one tray
- Trays are stain and odor resistant
- NSF Listed; dishwasher safe



Guarantee: Carlisle will replace at no charge any Griptite Tray that does not last 5 years from the date of purchase under normal foodservice conditions.

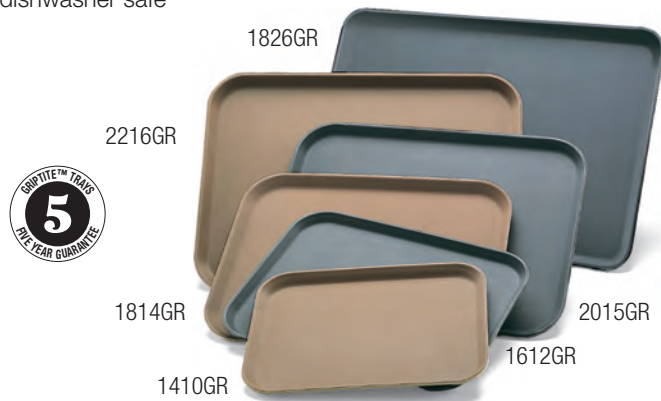

## GripLite® Trays

- Economical trays are made of a high density polypropylene co-polymer
- Molded-in rubber liner prevents slipping and sliding of glasses and dinnerware
- A more sanitary alternative to cork trays
- Stain and odor resistant
- Does not have 5 year warranty like the Griptite Trays, shown above
- Handwashing is recommended



## Cork Trays

- Available in economical, lightweight, break-resistant polypropylene for bar service or break-resistant, sturdy ABS for heavy-duty use and greater stability
- Both offer durable plastic construction and will not chip or dent
- The cork surface is bonded to the tray and treated to reduce wear and increase durability
- Replacement cork available on page 302
- Handwashing is recommended

Money Maids™ can be used with our Griptite, GripLite or Cork Trays! See page 117 for additional information.



## Tray Stands

- Available in 3 forms: Steel, Wood & Plastic
- Cross supports provide superior rigidity and strength
- Durable and easy to clean
- Black plastic capped legs on steel tray stands prevent slipping and marring of floors
- Extra tall steel tray stand (C3625T) reduces need for bending and stooping; additional height makes transferring heavy loads easier
- Wood tray stands constructed of kiln-dried hardwood
- Plastic stand trays have sanitary, non-porous & non-corrosive finish that is easy to clean with a damp cloth
- Works best with Griptite and GripLite trays



Prod No	Description	Color	Pack	Cs Wt/Cube
<b>Griptite Trays</b>				
1100GR $\Delta$	11.00/0.76 Round Tray	004, 076	12 ea	9.00/0.35
1400GR $\Delta$	14.00/0.76 Round Tray	004, 076	12 ea	15.80/0.62
1600GR $\Delta$	16.00/0.73 Round Tray	004, 076	12 ea	20.00/0.72
2500GR $\Delta$	24.00/19.25/1.18 Oval Tray	004, 076	6 ea	20.50/0.82
2700GR $\Delta$	27.06/22.31/1.15 Oval Tray	004, 076	6 ea	25.30/1.13
3100GR $\Delta$	31.5/23.5/1.15 Oval Tray	004, 076	6 ea	33.00/1.43
1410GR $\Delta$	13.81/10.62/0.84 Rectangular Tray	004, 076	12 ea	13.00/0.46
1612GR $\Delta$	16.37/12.00/0.75 Rectangular Tray	004, 076	12 ea	19.75/0.55
1814GR $\Delta$	18.00/14.00/0.84 Rectangular Tray	004, 076	12 ea	24.60/0.59
3253GR $\Delta$	20.87/12.75/1.18 Gastronorm Tray	004, 076	12 ea	28.00/0.80
2015GR $\Delta$	20.25/15.00/1.18 Rectangular Tray	004, 076	12 ea	29.10/0.82
2216GR $\Delta$	22.00/16.00/1.18 Rectangular Tray	004, 076	12 ea	35.05/1.00
1826GR $\Delta$	25.75/18.00/1.18 Rectangular Tray	004, 076	12 ea	45.70/1.64
<b>GripLite Trays</b>				
1100GL	11.25/0.76 Round Tray	004, 076	12 ea	7.30/0.31
1400GL	14.63/0.76 Round Tray	004, 076	12 ea	12.96/0.62
1600GL	16.44/0.73 Round Tray	004, 076	12 ea	20.00/0.72
<b>Cork Trays</b>				
3014	14.00/0.75 Round Tray	01	12 ea	12.00/0.53
3016	16.00/0.75 Round Tray	01	12 ea	15.89/0.67
2419	24.00/19.00/0.75 Oval Tray	01	6 ea	16.82/0.98
2823	28.00/23.00/0.75 Oval Tray	01	6 ea	23.00/1.32
3013	13.88/0.75 Round Tray	01	12 ea	9.20/0.57
3015	15.88/0.75 Round Tray	01	12 ea	13.60/0.62
<b>Tray Stands</b>				
C3625	31.5" Steel Stand	03	6 ea	38.75/5.65
C3625T	36" Tall Steel Stand	38	6 ea	56.00/6.59
C3620W	30" Wood Stand	11	6 ea	32.75/5.54
C3622	31" Deluxe Wood Stand	076	1 ea	6.00/1.31
C3630W	30.5" Plastic Stand	11	6 ea	35.90/5.51

NSF Listed products are designated with a  $\Delta$

Note: C3630W, C3620W, and C3625 can ship UPS/FedEx Ground at oversize cost

# SERVING TRAYS

## Celebration Trays

- Large trays are perfect for serving bread, cheeses, hors d'oeuvres, and pastries
- Economically priced trays are perfect for offsite catering or buffet displays
- Sturdy and reusable, they are the perfect alternative to disposables
- Chrome-plated, mirror polished finish never requires polishing
- Handwash only; polish dry with soft cloth



608907

608905

Round



608913

608919

608904

Oval



608918

608908

Rectangular



608901

608902

Octagonal



1089RS

## Room Service Trays

- Traditional design goes with a variety of decors
- Handled tray with rimmed edge keeps tray top items securely in place
- Trays are made of durable ABS
- They are stackable and dishwasher safe

### Festival Trays™

- Beautiful alternative to glass, crystal, or disposables
- Use durable trays for catering, parties, weddings, conventions, cruise lines, or poolside service
- Molded-in pattern gives the appearance of fine etched crystal
- Economical, break-resistant SAN resists food acids and oils
- Lowers replacement costs
- Safe in temperatures from 0° to 180°F
- Dishwasher safe



### Round Heavy-Weight Tray

- Elegant simplicity with smooth rich finish and rolled rim handle edge
- 18-8 stainless steel with mirror-polish finish
- Designed to stand up to frequent use
- Handwashing is recommended



Black(03)



Clear(07)

Prod No	Description	Color	Pack	Cs Wt/Cube
<b>Celebration Trays</b>				
608905	13" Round Gadroon Tray	–	12 ea	9.00/0.22
608907	14" Round Gadroon Tray	–	12 ea	11.00/0.25.25
608919	20.88" x 13.5" Oval Tray with Integral Handles	–	12 ea	24.00/0.43
608904	17.75" x 12.88" Oval Tray with Ornate Border	–	12 ea	15.00/0.25
608913	17.75" x 12.88" Oval Tray with Gold Border	–	12 ea	14.50/0.38
608918	21" x 15" Rectangular Tray with Ornate Border	–	12 ea	25.00/0.51
608908	18.25" x 12.38" Rectangular Tray with Gold Border	–	12 ea	20.00/3.06
608909	20.63" x 14" Rectangular Tray with Gold Border	–	12 ea	25.00/3.82
608901	17.13" x 11.75" Octagonal Tray with Beaded Border	–	12 ea	17.00/0.25
608902	20" x 13.75" Octagonal Tray with Beaded Border	–	12 ea	22.50/0.80
<b>Room Service Trays</b>				
1089RS	21.5" x 15.5" Room Service Tray	03	12 ea	28.22/1.41
1089RS1520	20" x 15.5" Room Service Tray	03	12 ea	24.25/1.14
<b>Festival Trays</b>				
6413	13" Round Tray	07	12 ea	10.40/0.46
6416	16" Round Tray	07	12 ea	14.65/0.64
6417	12.5" x 7" Rectangular Tray	07	12 ea	3.65/0.16
6450	15" x 10.75" Rectangular Tray	07	12 ea	12.20/0.45
6426	22" x 16" Handled Tray	07	6 ea	15.95/1.04
6439	13" x 19.5" Handled Tray	07	6 ea	11.00/0.70
<b>Round Heavy-Weight Tray</b>				
608917	22" Round Heavy-Weight Tray	–	3 ea	16.97/0.78

# COMPARTMENT TRAYS

## Compartment Trays

- Carlisle offers the largest variety of sizes and compartment combinations available
- The 6-compartment trays hold government "Type A" lunch
- All materials are FDA approved

### Material Choices:

#### Melamine

- Melamine is a heavy, rigid material with the look and feel of china
- It is very scratch and break-resistant
- Fast drying melamine is highly resistant to chemicals and food acids with a temperature range of 0° to 212°F
- NSF Listed; dishwasher safe

#### Polycarbonate

- Money saving trays carry a five-year warranty against breakage
- Highly break-resistant; perfect choice for correctional facilities
- Polycarbonate offers good scratch and chemical resistance with a temperature range of -40° to 212°F
- NSF Listed; dishwasher safe

#### Polypropylene

- Economical, durable choice
- Good chemical resistance
- Temperature range of 30° to 180°F
- Handwashing is recommended
- NSF Listed

#### ABS

- Break & scratch-resistant
- Excellent choice for general use
- Highly resistant to chemicals and food acids with a temperature range of 0° to 180°F
- NSF Listed; dishwasher safe



## 6-Compartment Trays

### Left-Hand Compartment Trays, Right-Hand Compartment Trays

- Offer a greater variety of serving combinations with three smaller upper compartments, two larger lower compartments, and a flatware holder on right or left side
- Available in melamine, polycarbonate, ABS, and polypropylene
- NSF Listed, except when offered in Variegated(00)

### Omni-Directional Trays Space Saver Trays

- Special design allows you to fit two trays side by side in dish rack for faster cycling time



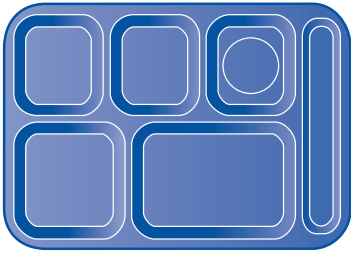

Right-Hand Tray  
(43988, 43989, 614R, P614R)

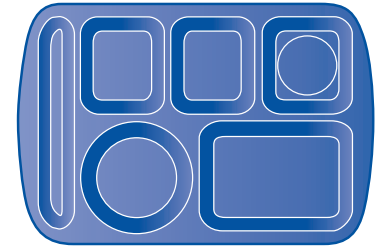

Handled Economy Left-Hand Tray  
(5865)

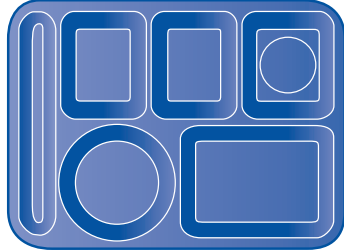

Left-Hand Tray  
(43980, 43981, 614, P614, 614PC)



Space-Saver Omni-Directional Tray (615)  
\* Licensed Product under U.S. Patent D292,768

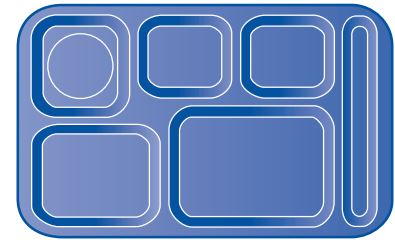

Space-Saver Right-Hand Tray  
(43982, 43983)



Prod No	Description	Color	Pack	Cs Wt/Cube
<b>6 - Compartment Trays</b>				
<b>Right-Hand Trays</b>				
43988 $\Delta$	Heavy-weight Melamine Tray	02, 05, 08, 25, 34, 35, 50, 59, 64, 85, 87	12 ea	16.10/0.73
43989 $\Delta$	Heavy-weight Sandshades/ Rose Granite Melamine	00, 92, 93	12 ea	14.00/0.68
614R	ABS Tray	03, 05, 09, 25, 59	24 ea	20.21/1.05
P614R	Polypropylene Tray	05, 09, 14, 25	24 ea	16.75/1.01
<b>Space-Saver Right-Hand Tray</b>				
43982 $\Delta$	Space-Saver Melamine Tray	05, 08, 50, 59	12 ea	17.35/0.77
43983 $\Delta$	Space-Saver Sandshades Melamine Tray	92	12 ea	17.75/0.78
<b>Left-Hand Trays</b>				
43980 $\Delta$	Heavy-weight Melamine Tray	04, 05, 08, 25, 35, 50, 59, 64, 85, 87	12 ea	13.95/0.58
43981 $\Delta$	Heavy-weight Sandshades/Rose Granite Melamine	00*, 92, 93	12 ea	14.10/0.58
614PC †	Polycarbonate Tray	25	24 ea	19.39/0.60
614	ABS Tray	03	24 ea	16.85/0.60
P614	Polypropylene Tray	05, 25	24 ea	12.19/0.60
<b>Handled Economy Melamine Left-Hand Tray</b>				
5865	Handled Economy Melamine Tray, Variegated	00	12 ea	11.65/0.33
<b>Space-Saver Omni-Directional Tray</b>				
615**	Space-Saver ABS Tray	03, 05, 14, 25	24 ea	16.80/0.94

NSF Listed products are designated with a  $\Delta$ ; \*Note: Variegated(00) option is not NSF Listed  
 Rose Granite, Sandshades, and Variegated items vary in color, hue, and intensity from piece to piece  
 † 614PC carries a 5-year warranty against breakage  
 \*\*615 is a licensed product under U.S. Patent D292, 768

# COMPARTMENT TRAYS & TRAY COVERS



PCD801



KL444

43986



43984

## 5-Compartment Trays

### Polycarbonate Compartment Trays

- Offer a 5-year warranty against breakage
- Inside compartments have a textured surface for greater scratch resistance
- NSF Listed; dishwasher safe

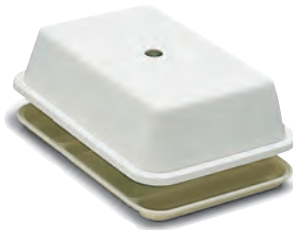

10145

## 4-Compartment Trays

- Smaller size trays are perfect for elementary schools and lunch menus
- Omni-directional KL444 and 43986 trays features two-way stacking
- NSF Listed; dishwasher safe



SC26

SC27

## Compartment Tray Cover

- Help maintain food temperatures and protect food from contamination and spills
- Dishwasher safe

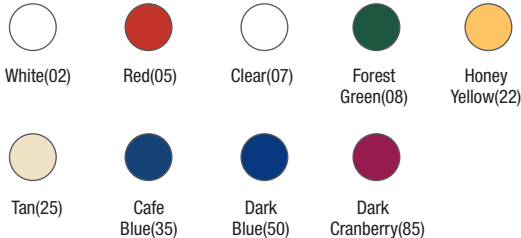

## Pastry Tray Covers

- Clear covers offer best visibility in bakeries, delis, and convenience stores
- Sanitary covers help preserve taste and quality
- Rust-proof stainless steel hinges and screws provide long life
- Use with Carlisle trays, see pages 122 & 123 for corresponding trays

### Carlisle Tray Guide

SC25 & SC26 fit 2618FG, 2618DFG, 2618WFG trays  
 SC27 & SC29 fit 1220FG, 1220DFG, 1220WFG trays  
 SC40 fits 1318FG, 1318DFG, 1318WFG trays

Prod No	Description	Color	Pack	Cs Wt/Cube
<b>5-Compartment Trays</b>				
PCD801 <span style="color: green;">Δ</span>	5-Compartment Tray 11.50/10.50/1.00	25	24 ea	21.05/0.63
<b>4-Compartment Trays</b>				
43984 <span style="color: green;">Δ</span>	4-Compartment Tray, Right-Hand 10.11/9.79/0.51	05, 22, 50	48 ea	36.53/1.60
43986 <span style="color: green;">Δ</span>	4-Compartment Server Tray, 10.30/9.58/0.85	25, 35	36 ea	28.50/1.09
KL444 <span style="color: green;">Δ</span>	4-Compartment Tray, 10.95/8.67/0.62	08, 85	12 ea	8.95/0.36
<b>Compartment Tray Cover</b>				
10145	Cover Fits Non-Handled Right and Left Handed 6-Compartment Trays	02	12 ea	11.20/0.80
<b>Pastry Tray Covers</b>				
SC25	26" x 18" x 4" Cover	07	1 ea	6.65/1.76
SC26	26" x 18" x 4" Hinged Cover	07	1 ea	6.85/1.77
SC27	20" x 12" x 4" Cover	07	3 ea	9.90/1.93
SC29	20" x 12" x 4" Hinged Cover	07	3 ea	9.85/1.91
SC40	18" x 13" x 4" Cover	07	1 ea	3.80/1.60

NSF Listed products are designated with a Δ



# CATERING EQUIPMENT

Carlisle's Cateraide line is the professional's choice for well-designed, hard-working catering products that perform. All of our catering equipment is perfect for all catering jobs, from large to small by being easy to load, move and carry – all while meeting tough NSF standards.

<b>Product</b>	<b>Page</b>
Beverage Servers	
Cateraide LD Series Insulated Beverage Servers . . . . .	.139
Cateraide Slide 'N Seal Beverage Servers . . . . .	.138
Cateraide XT Series Insulated Beverage Servers . . . . .	.138
CaterCooler . . . . .	.136
Dollies	
Cateraide Dollies . . . . .	.137
Cateraide Universal Dolly . . . . .	.137
MY410 End Loader Dolly . . . . .	.134
End Loaders	
Cateraide Insulated End Loader . . . . .	.136
Cateraide Slide 'N Seal End Loaders . . . . .	.135
MY400 End Loader . . . . .	.134

<b>Product</b>	<b>Page</b>
Ice Caddies . . . . .	.140
Pan Carriers . . . . .	.136
Sheet Pan Carriers . . . . .	.136
Soup & Chili Servers . . . . .	.139
Top Loaders	
Cateraide Insulated Top Loaders . . . . .	.136
Cateraide Slide 'N Seal Top Loaders . . . . .	.135
Tray Carriers . . . . .	.136

# INSULATED PAN CARRIERS

## MY400 End Loader

- Durable polyethylene with thick foam insulation
- Heat resistant to 200° F
- Accepts casters directly for easy transportation
- NSF Listed

US Patent No. D637,373

Ergonomic design lends to stacking, storing and comfortable two-person transportation



## MY410 End Loader Dolly

- Holds MY400 End Loader
- 5" Casters; 2 fixed, 2 swivel, 1 with brake

Holds up to six 2.5" food pans



### Cold Retention



### Heat Retention







**Cateraide Slide 'N Seal™  
Top Loaders and End Loaders**

- Revolutionary Slide 'N Seal design is combined with Carlisle's thick insulation to hold temperatures longer
- Patented\* Slide 'N Seal lids and doors glide shut and stay closed without latches or gaskets
- The integrated seal keeps food hot or cold longer
- Self-venting lids and doors keep foods fresher, crisper and more appetizing
- Exclusive lid design has a molded-in tethered lock pin to seal carrier for safety
- End Loader has molded-in tag slot to seal and tag carrier for safety and food identification
- Sleek contemporary appearance; ergonomically designed for easy loading, handling, stacking and storing
- Tough, scratch-resistant polyethylene construction is easy to clean and maintain
- No metal parts – ideal for correctional facilities
- NSF Listed

\*Slide 'N Seal Patents  
Pan Carriers: Patent No. 7,134,552

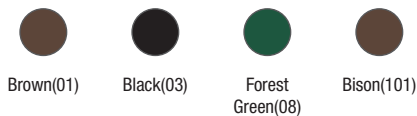

Prod No	Description	Color	Pack	Cs Wt/Cube
<b>MY End Loaders</b>				
MY400 Δ	Standard End Loader without Casters	03, 08, 101	1 ea	33.00/9.40
MY410 Δ	Dolly for End Loader (Standard Caster)	03	1 ea	17.00/2.91
MYCK Δ	Standard Caster Kit	—	1 ea	10.00/0.79
<b>Slide 'N Seal Top Loaders</b>				
XT1400 Δ	4" Slide 'N Seal Top Loader	03	1 ea	18.35/2.82
XT1600 Δ	6" Slide 'N Seal Top Loader	01, 03, 08	1 ea	20.55/3.37
XT1800 Δ	8" Slide 'N Seal Top Loader	01, 03	1 ea	22.00/3.86
<b>Slide 'N Seal End Loaders</b>				
XT3000R Δ	Slide 'N Seal End Loader	01, 03	1 ea	20.00/8.10

NSF Listed products are designated with a Δ

# INSULATED PAN CARRIERS & DOLLIES

PC180N

PC140N



Reshoot or color correct  
 PC180N not available in green  
 PC188N not available in brown

PC188N

PC160N



## All Cateraide Pan Carriers

- Cateraide construction made of rugged, stain- and scratch-resistant polyethylene
- Filled with extra thick foam insulation for maximum temperature retention
- Exclusive automatic self-venting system eliminates unsanitary vent openings and easily lost vent caps
- Heat resistant to 200°F
- Replacement parts shown on pages 302
- NSF Listed

## Cateraide Insulated Top Loaders

- Accommodates all third, half, and full size food pans
- PC188N top loader holds up to 8" deep food pan

## Cateraide Insulated Sheet Pan & Tray Carrier

- Individual tracks accommodate seven 18" x 26" trays
- Use with sheet pans shown on page 151
- NSF Listed



TC1826N



PC600N

## Cateraide Insulated End Loader Pan Carrier

- Individual track for each food pan
- PC300N end loader holds five 2.5" deep pans
- PC600N has twice the capacity of the PC300N
- PC600N's separate compartments enable you to put hot food in one; cold in the other
- NSF Listed



PC300N

Use with DuraPan™ or Top Notch® Food Pans shown on pages 178, 180 & 181

CaterCooler shown with PC300N End Loader

## CaterCooler™

- Freeze CaterCooler overnight or for eight hours and it will keep food at or below the ServSafe® guidelines of 40°F for up to eight hours without ice\*
- Designed to slide into a Cateraide End Loader, Double End Loader, or place on top of food pans in a Top Loader
- Durable polyethylene shell

ServSafe® is a registered trademark of the National Restaurant Association  
 \*Temperature retention is based on CaterCooler being pre-frozen for a minimum of eight hours, then placed directly into Cateraide pan carrier. Pan Carrier unit is then filled with pre-chilled food pans. Testing was conducted under ambient room temperatures of 76°F.



PC660





### Cateraide Dollies Polyethylene Dollies

- 4" heavy-duty, quiet and non-marking swivel casters
- Rolls easily on carpeted floors
- DL300R holds up to two Cateraide End Loaders (PC300N) or any Cateraide Top Loader
- XDL3000 holds up to two Slide 'N Seal End Loaders (XT3000R) when stacked
- NSF Listed

### Aluminum Dollies

- Made of sturdy, light-weight, no-rust aluminum
- Plastic coated corner bumpers protect against marring furnishings
- 4" heavy-duty, quiet and non-marking swivel casters
- Rolls easily on carpeted floors
- DL300 holds up to two stacked Cateraide End Loaders
- DL1826 holds up to three stacked Sheet Pan Carriers

### Cateraide Universal Dolly

- Moves up to 6 fully loaded top loaders with ease, even on carpeted floors
- 600 lb load capacity
- Eyelets for cargo straps
- 5" non-marking casters (2 rigid, 2 swivel-one with brake)
- NSF Listed



Prod No	Description	Color	Pack	Cs Wt/Cube
<b>Cateraide Insulated Top Loaders</b>				
PC140N Δ	12 qt, 4" Single Pan Carrier	01, 03	1 ea	14.10/2.03
PC160N Δ	18 qt, 6" Single Pan Carrier	01, 03	1 ea	16.50/2.63
PC188N Δ	24 qt, 8" Single Pan Carrier	03, 08	1 ea	20.00/3.17
PC180N Δ	24 qt, 8" Combination Pan Carrier	01, 03	1 ea	26.00/4.44
<b>Cateraide Insulated End Loaders</b>				
PC300N Δ	End Loader	01, 03, 08, 59, 95	1 ea	30.50/6.33
PC600N Δ	Double End Loader	01, 03, 08, 59	1 ea	73.00/13.00
<b>Cateraide Insulated Sheet Pan &amp; Tray Carrier</b>				
TC1826N Δ	Sheet Pan, Tray Carrier	01, 03	1 ea	45.00/8.74
<b>CaterCooler</b>				
PC660	CaterCooler	14	1 ea	12.30/0.46
<b>Heavy-Duty Polyethylene Cateraide Dollies</b>				
XDL3000H Δ	22.38" x 28.75" Dolly with Handle	03	1 ea	29.00/4.06
DL300R Δ	20.38" x 26.75" Dolly	03	1 ea	21.00/4.14
<b>Aluminum Cateraide Dollies</b>				
DL300	23.25" x 16.88" Dolly	23	1 ea	12.90/2.41
DL1826	28.63" x 22" Dolly	23	1 ea	13.35/2.90
<b>Cateraide Universal Dolly</b>				
UD1726 Δ	Universal Dolly	03	1 ea	43.65/8.59

NSF Listed products are designated with a Δ  
NOTE: Cateraide Universal Dolly is not UPS/FedEx Ground shippable



# INSULATED BEVERAGE DISPENSERS



## Cateraide Slide 'N Seal Beverage Dispenser

### Body and Lid

- Revolutionary Slide 'N Seal design is combined with Carlisle's thick insulation to hold temperatures longer
- Patented\* Slide 'N Seal design glides shut and closes tight - all without latches
- The integrated seal keeps beverages hot or cold longer
- Sleek contemporary appearance; ergonomically designed for easy loading, handling, stacking and storing
- Tough, scratch-resistant polyethylene construction is easy to clean and maintain
- No metal parts – ideal for correctional facilities
- NSF Listed

### Faucet

- "Spring action" faucet for dripless service
- NSF Listed

\*Slide 'N Seal Patents:  
Beverage Dispensers: Patent No. 7,328,816



Easy twist on/off lid for leak-proof transport



Molded-in handles for easy transport



Lock can be placed through molded-in tag hole for a secure, tamper-proof closure

## Cateraide XT Series Insulated Beverage Servers

### Body and Lid

- Made of rugged, stain- and scratch-resistant polyethylene
- Filled with extra thick foam insulation for maximum temperature retention
- Stacks with itself and with other major competitors
- Smooth interior walls and rounded corners leaves no food traps and provides quick clean-up
- Convex lid design prevents leaks during use as pressure increases
- Modern XT lid design with convenient pop-up vent
- Improved o-ring seal eliminate leaks during transport
- Easy-grip, formed handles for transporting;
- NSF Listed

### Latches

- Sure-Latch™ wide design has three times the latch area of other beverage servers for a secure seal
- Latches are mounted into steel reinforcement plates for long life
- NSF Listed

### Faucet

- "Spring action" faucet for dripless service
- NSF Listed





## Cateraide LD Series Insulated Beverage Servers

### Body and Lid

- Made of rugged, stain- and scratch-resistant polyethylene
- Filled with extra thick foam insulation for maximum temperature retention
- Stacks with itself and with other major competitors
- Smooth interior walls and rounded corners leaves no food traps and provides quick clean-up
- Convex lid design prevents leaks during use as pressure increases
- Reinforced, tight-fitting lids with O-ring seals prevent leaks and provide increased heat retention
- Easy-grip, formed handles for transporting
- NSF Listed

### Faucet

- “Spring action” faucet for dripless service
- NSF Listed

### Latches

- Nylex II™ latches have no sharp edges, won't rust, bend or dent like metal and are mounted into steel reinforcement plates for long life
- NSF Listed



## Cateraide Insulated Soup & Chili Servers

- Same high-quality features and construction as the standard Cateraide
- Perfect for transporting and serving soup and chili
- Stacks with 2.5 gallon and 5 gallon beverage servers
- There are no faucets
- NSF Listed



Brown(01)



Black(03)



Forest Green(08)



Slate(59)

Prod No	Description	Color	Pack	Cs Wt/Cube
<b>Slide 'N Seal Beverage Dispensers</b>				
XB3 Δ	3 gal Slide 'N Seal Beverage Dispenser	03	1 ea	11.00/3.40
XB5 Δ	5 gal Slide 'N Seal Beverage Dispenser	01, 03, 08	1 ea	18.00/4.68
<b>Cateraide XT Beverage Servers</b>				
XT2500 Δ	2.5 gal Beverage Server	01, 03, 08, 59	1 ea	13.00/2.07
XT5000 Δ	5 gal Beverage Server	01, 03, 08, 59	1 ea	20.00/2.78
XT10000 Δ	10 gal Beverage Server	01, 03, 08, 59	1 ea	30.60/5.67
<b>Cateraide LD Beverage Servers</b>				
LD250N Δ	2.5 gal Beverage Server	01, 03	1 ea	12.75/2.02
LD500N Δ	5 gal Beverage Server	01, 03, 08, 59	1 ea	16.00/2.33
LD1000N Δ	10 gal Beverage Server	01, 03, 08, 59	1 ea	26.60/5.01
<b>Cateraide Insulated Soup &amp; Chili Servers</b>				
LD350N Δ	3.5 gal Soup & Chili Server	01, 03	1 ea	12.30/1.78
LD500NSS Δ	5 gal Soup & Chili Server	01, 03	1 ea	17.75/2.25

NSF Listed products are designated with a Δ

NOTE: XT10000, LD1000N, LD500NSS can be shipped UPS/FedEx Ground at oversize cost

# INSULATED ICE CADDIES

## Cateraide™ Ice Caddies

- Cateraide construction made of rugged, stain- and scratch-resistant polyethylene
- Filled with extra thick foam insulation for maximum temperature retention
- Rounded inside corners and removable lid for thorough cleaning
- Stainless steel, reinforced hinges prevent rusting
- Easy rolling, heavy-duty 5" casters
- Replacement parts shown on pages 302

### 200 Lb Caddy

- Lid opens and lays flat against side of unit to conserve space
- Front faucet for fast drainage and easy cleanup; inside has sloped base for complete drainage
- Includes convenient shelf; allows water to drain away from ice
- Dual handles for easy maneuverability
- 10" non-marking back wheels roll easily over rough surfaces



IC2220

### 125 Lb Caddies

- Nylex™ latches eliminate sharp edges; won't rust, bend, or dent
- Ice Caddies IC2250 and IC2254 are only 28.75" high for smaller, more compact space requirements
- IC2250T Ice Caddy is 36.5" high to reduce back bending motion
- IC2250T Ice Caddy has 8" non-marking back wheels for easy maneuvering over rough surfaces
- NSF Listed



IC2250T

IC2254

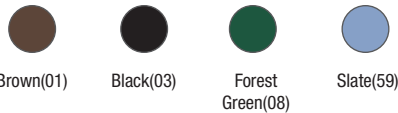

Prod No	Description	Color	Pack	Cs Wt/Cube
<b>Cateraide Ice Caddies</b>				
IC2220	200 lb Ice Caddy with Ice Caddy Shelf; 10" Wheels, 2 Swivel Casters (one with brake)	01, 03, 08, 59	1 ea	74.00/17.99
IC2250 Δ	125 lb Ice Caddy; 2 Rigid Casters, 2 Swivel Casters (one with brake)	01, 03	1 ea	49.00/11.63
IC2254 Δ	125 lb Ice Caddy; 4 Swivel Casters (one with brake)	01, 03	1 ea	55.00/11.56
IC2250T Δ	125 lb Tall Ice Caddy; 8" Wheels, 2 Swivel Casters (one with brake)	03	1 ea	57.00/14.56

NSF Listed products are designated with a Δ  
 Note: Ice Caddies cannot ship UPS/FedEx Ground



# PROFESSIONAL COOKWARE

Chefs love how Carlisle is able to meet their needs for Professional Cookware and Bakeware. Our wide selection of pots, pans, and specialty cookware means you get the right product that fits your specifications, all from one company, Carlisle.

<b>Product</b>	<b>Page</b>
Bakeware .....	150-152
Baking Pans .....	150 & 151
Baskets .....	148
Braziers .....	144 & 146
Bread Pans .....	150 & 151
Bun Pans & Sheet Pans .....	151
Burger Covers .....	148
Cookware .....	144-148
Covers .....	144 & 148
Double Boiler .....	148
Fry Pans .....	142-145
Fryer Baskets .....	148
Icing Grates .....	152

<b>Product</b>	<b>Page</b>
Muffin Pans .....	150 & 152
Pans, Pullman & Bread .....	151
Pasta Cookers, Sectional .....	147
Pie Pans .....	152
Roasters .....	150
Sauce Pans .....	144 & 146
Sauce Pots .....	144
Sauté Pans .....	144 & 146
Sheet Pans .....	151
Springform Pans .....	152
Standard Weight Aluminum Cookware .....	146
Stock Pots .....	144 & 146
Versata Select .....	144

# FRY PANS

## SSAL™ Fry Pans

- Finest 18-8 stainless interior is permanently bonded to hard aluminum body to create the ultimate fry pan for any foodservice environment
- Aluminum body ensures maximum heat transfer throughout the pan and eliminates hot spots and scorching
- Easy care stainless interior is incredibly durable and will not react with food or discolor sauces
- Special rivet design securely attaches handle to pan; bond will not loosen like traditional rivets
- NSF Listed



60910RS  
60912RS  
60914RS



60907RS

60908RS



60910SERS  
60912SERS  
60914SERS



60908SERS

60907SERS



60710RS  
60712RS



60708RS

## Traditional Aluminum Fry Pans

- Gently sloped sides are ideal for turning, flipping, and removing foods
- Aluminum material provides excellent heat transfer
- Hard 3004 aluminum body stands up to the toughest foodservice environment
- NSF Listed

Covers sold separately on pages 144 & 148; recommended covers are listed in the product chart on facing page.

## Teflon Select® Fry Pan

- Teflon Select, DuPont's professional non-stick surface is extremely durable and extra smooth
- Improved coating features 75% greater longevity and 75% more resistance to abrasion than regular Teflon
- Hard 3004 aluminum body stands up to the toughest foodservice environment
- Use with High Heat Turner shown on page 168 of the foodservice catalog
- NSF Listed



## Excalibur® Fry Pans

- Excalibur's revolutionary reinforced non-stick coating is superior to any standard coating
- Stainless steel reinforced non-stick coating is micro-bonded to the substrate of the pan creating a multi-layer surface that easily releases food and resists scratching better than traditional non-stick surfaces
- Excalibur cooks food evenly without the need for added fat or oil
- Hard 3004 aluminum body stands up to the toughest foodservice environment
- Use with High Heat Turner shown on page 168 of the foodservice catalog
- NSF Listed

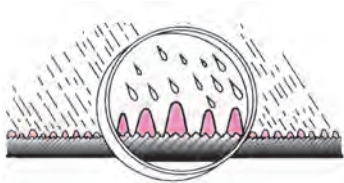

Excalibur® surface resists scratching from metal utensils better than any other coating

60910XRS  
60912XRS  
60914XRS

60908XRS

60907XRS



### Cash 'N Carry

Selected products also available in a cash 'n carry pack. See pages 280-283.

Fry Pans come with removable Dura-Kool™ sleeves

Prod No	Description	Cover	Pack	Cs Wt/Cube
<b>SSAL Fry Pans</b>				
60708RS <b>Δ C</b>	8" SSAL Fry Pan	60908C	12 ea	17.00/0.69
60710RS <b>Δ C</b>	10" SSAL Fry Pan	60910C	6 ea	16.00/0.68
60712RS <b>Δ C</b>	12" SSAL Fry Pan	60912C	6 ea	19.00/0.78
<b>Traditional Aluminum Fry Pans</b>				
60907RS <b>Δ C</b>	7" Aluminum Fry Pan	60907C	12 ea	15.00/0.53
60908RS <b>Δ C</b>	8" Aluminum Fry Pan	60908C	12 ea	19.00/0.77
60910RS <b>Δ C</b>	10" Aluminum Fry Pan	60910C	6 ea	16.00/0.76
60912RS <b>Δ C</b>	12" Aluminum Fry Pan	60912C	6 ea	21.00/1.13
60914RS <b>Δ C</b>	14" Aluminum Fry Pan	60914C	3 ea	15.00/1.42
<b>Teflon Select Fry Pans</b>				
60907SERS <b>Δ C</b>	7" Teflon Select Fry Pan	60907C	12 ea	15.00/0.53
60908SERS <b>Δ C</b>	8" Teflon Select Fry Pan	60908C	12 ea	19.00/0.77
60910SERS <b>Δ C</b>	10" Teflon Select Fry Pan	60910C	6 ea	16.00/0.76
60912SERS <b>Δ C</b>	12" Teflon Select Fry Pan	60912C	6 ea	21.00/1.13
60914SERS <b>Δ C</b>	14" Teflon Select Fry Pan	60914C	3 ea	15.00/1.42
<b>Excalibur Fry Pans</b>				
60907XRS <b>Δ C</b>	7" Excalibur Fry Pan	60907C	12 ea	15.00/0.53
60908XRS <b>Δ C</b>	8" Excalibur Fry Pan	60908C	12 ea	19.00/0.77
60910XRS <b>Δ C</b>	10" Excalibur Fry Pan	60910C	6 ea	16.00/0.76
60912XRS <b>Δ C</b>	12" Excalibur Fry Pan	60912C	6 ea	21.00/1.13
60914XRS <b>Δ C</b>	14" Excalibur Fry Pan	60914C	3 ea	15.00/1.42

NSF Listed products are designated with a **Δ**

Cash 'N Carry products are designated with a **C**

Teflon® is a registered trademark of E.I. DuPont® DeNemours & Co., Inc.  
Excalibur® is a registered trademark of Whitford B. U. Corp.

# COOKWARE



**Stock Pots**



**Sauce Pots**



**Sauce Pans**



**Covers**

## Fry Pans

- Heavy-duty 18-10 stainless steel with encapsulated aluminum base for superior heat diffusion on either induction or conventional cook tops
- Rolled edges for added strength and easy pouring
- Stainless steel surface will not react with food or discolor sauces
- Easy clean satin finish interior allows you to cook with less fat or oil

## Versata Fry Pans With Excalibur® Non-Stick Coating

- Versata Fry pans with Excalibur stainless steel reinforced non-stick coating
- Coating is micro-bonded to the substrate of the pan creating a multi-layer surface that easily releases food and resists scratching better than traditional non-stick surfaces

## Versata Select™ Cookware

- Heavy-duty 18-10 stainless steel cookware is induction ready
- Rolled edges for added strength and easy pouring
- High polish rims are perfect for display cooking
- Encapsulated bottoms have two layers of stainless steel with a thick aluminum core for superior heat diffusion on either induction or conventional cook tops
- Stock and sauce pots have loop handle design
- Easy clean satin finish interior allows you to cook with less fat or oil
- Covers sold separately; see product chart for recommended cover
- NSF Listed

## Stock Pots

- Perfect for preparing soups, pasta, or long-simmering stocks and sauces

## Sauce Pots

- Wider pots with lower sidewalls for smaller preparations
- Use for foods cooked with liquid over medium heat that require frequent stirring or handling

## Sauce Pans

- Wide base diameters provide more surface area for stirring and working with food
- Use for reducing sauces, or cooking soups and gravies

## Covers

- Domed covers fit snugly on the pans creating a self-basting effect by allowing moisture to condense and return to the pan
- Strong welds insure long life



**Cash 'N Carry**

Selected products also available in a cash 'n carry pack. See pages 280-283.

Prod No	Description	Cover	Pack	Cs Wt/Cube
<b>Versata Stock Pots</b>				
601109 $\Delta$ <b>C</b>	9 qt Versata Select Stock Pot	606009	1 ea	4.76/0.61
601112 $\Delta$ <b>C</b>	12 qt Versata Select Stock Pot	606010	1 ea	5.47/0.76
601116 $\Delta$ <b>C</b>	16 qt Versata Select Stock Pot	606011	1 ea	6.99/0.98
601125 $\Delta$ <b>C</b>	24 qt Versata Select Stock Pot	606013	1 ea	10.00/1.85
601132 $\Delta$ <b>C</b>	32 qt Versata Select Stock Pot	606014	1 ea	11.68/1.73
601144 $\Delta$ <b>C</b>	40 qt Versata Select Stock Pot	606015	1 ea	15.87/2.10
601164 $\Delta$ <b>C</b>	60 qt Versata Select Stock Pot *	606016	1 ea	18.38/3.18
<b>Versata Sauce Pots</b>				
601175 $\Delta$ <b>C</b>	6 qt Versata Select Sauce Pot	606009	1 ea	4.41/0.44
601111 $\Delta$ <b>C</b>	10 qt Versata Select Sauce Pot	606011	1 ea	5.73/0.65
601119 $\Delta$ <b>C</b>	18 qt Versata Select Sauce Pot	606014	1 ea	8.49/0.66
601123 $\Delta$ <b>C</b>	22 qt Versata Select Sauce Pot	606014	1 ea	9.55/1.29
601133 $\Delta$ <b>C</b>	32 qt Versata Select Sauce Pot	606015	1 ea	11.11/1.66
601146 $\Delta$ <b>C</b>	40 qt Versata Select Sauce Pot *	606017	1 ea	16.25/2.26
<b>Versata Sauce Pans</b>				
601025 $\Delta$ <b>C</b>	2.5 qt Versata Select Sauce Pan	606006	1 ea	2.49/0.20
601045 $\Delta$ <b>C</b>	4.5 qt Versata Select Sauce Pan	606007	1 ea	3.31/1.43
601075 $\Delta$ <b>C</b>	7 qt Versata Select Sauce Pan	606009	1 ea	4.43/0.52
<b>Versata Fry Pans</b>				
601008 $\Delta$ <b>C</b>	7" Versata Select Fry Pan	606007	1 ea	1.90/0.11
601009 $\Delta$ <b>C</b>	10" Versata Select Fry Pan	606009	1 ea	2.42/0.45
601012 $\Delta$ <b>C</b>	12" Versata Select Fry Pan	606122	1 ea	3.64/0.34
601014 $\Delta$ <b>C</b>	14" Versata Select Fry Pan	606014	1 ea	5.11/0.47
<b>Versata Fry Pans With Excalibur Non-Stick Coating</b>				
601008X $\Delta$ <b>C</b>	7" Versata Select Coated Fry Pan	606007	1 ea	1.90/0.11
601009X $\Delta$ <b>C</b>	10" Versata Select Coated Fry Pan	606009	1 ea	2.42/0.45
601012X $\Delta$ <b>C</b>	12" Versata Select Coated Fry Pan	606122	1 ea	3.64/0.34
601014X $\Delta$ <b>C</b>	14" Versata Select Coated Fry Pan	606014	1 ea	5.11/0.47
<b>Versata Covers</b>				
606006 $\Delta$	6.5" Cover fits 601025	—	6 ea	4.50/0.40
606007 $\Delta$	7.88" Cover fits 601045, 601008	—	6 ea	5.11/0.59
606009 $\Delta$	9.5" Cover fits 601109, 601175, 601075, 601009	—	6 ea	7.80/0.83
606010 $\Delta$	10.25" Cover fits 601112	—	6 ea	10.00/1.85
606011 $\Delta$	11" Cover fits 601116, 601111	—	6 ea	8.93/1.30
606122 $\Delta$	12.5" Cover fits 601012	—	6 ea	12.43/1.64
606013 $\Delta$	13.13" Cover fits 601125	—	6 ea	13.62/2.18
606014 $\Delta$	14.25" Cover fits 601132, 601119, 601014, 601123	—	6 ea	16.31/2.39
606015 $\Delta$	15.75" Cover fits 601144, 601133	—	6 ea	19.18/3.08
606017 $\Delta$	17.75" Cover fits 601146	—	6 ea	26.12/3.59
606016 $\Delta$	19.5" Cover fits 601164	—	6 ea	30.42/4.42

NSF Listed products are designated with a  $\Delta$ Cash 'N Carry products are designated with a **C**

\*Not Induction Ready

# COOKWARE



## Standard Weight Aluminum Cookware

- Heavy cookware is made from 3003 alloy that allows cookware to heat rapidly and retain even heat
- Double thick top edge and base for superior strength and shape retention
- Covers sold separately; see product chart for recommended cover
- NSF Listed

## Stock Pots

- Perfect for preparing soups, pastas, or long-simmering stocks and sauces
- Can also be used with our stainless steel baskets for steaming, boiling, or deep frying

## Braziers

- Brazier's wide surface is perfect for browning meats and simmering stews
- Heavy plated loop handles for easy transport
- Optional covers maintain moist heat for slow cooking

## Sauté Pans

- Low sided sauté pans are designed for high heat browning or quick cooking
- Come with removable Dura-Kool sleeves
- Heavy-weight aluminum

## Straight Sided Aluminum Sauce Pans

- Rounded corners for easy stirring, helps prevent thick sauces from burning
- Heavy-duty, straight-sided pan's thick base provides quick and even heating for thorough cooking

## Tapered Aluminum Sauce Pans

- Tapered shape reduces contact with direct heat source and encourages cooking by diffusing heat from the side walls
- Sides are gently sloped and corners are rounded for easy stirring
- Tapered design nests for convenient storage
- Extra wide lip adds durability and offers more precise pouring
- 14 qt saucepan has side handle to aid lifting





## Sectional Pasta Cookers

- Ideal for pasta, vegetables, and seafood
- Save time, energy, and space by cooking multiple portions in one pot
- Stainless steel inserts with .13" holes feature cool-touch handles and can be hooked on the side of the pot for easy draining
- Complete unit includes 20 qt pot and 4 quarter size inserts



### Cash 'N Carry

Selected products also available in a cash 'n carry pack. See pages 280-283.

Prod No	Description	Cover	Pack	Cs Wt/Cube
<b>Standard Weight Stock Pots</b>				
61210 <b>Δ C</b>	10 qt Standard Weight Stock Pot	61210C	1 ea	4.00/0.53
61212 <b>Δ C</b>	12 qt Standard Weight Stock Pot	61210C	1 ea	4.30/0.79
61216 <b>Δ C</b>	16 qt Standard Weight Stock Pot	61216C	1 ea	5.20/0.97
61220 <b>Δ C</b>	20 qt Standard Weight Stock Pot	61220C	1 ea	6.50/1.20
61224 <b>Δ C</b>	24 qt Standard Weight Stock Pot	61224C	1 ea	6.50/1.43
61232 <b>Δ C</b>	32 qt Standard Weight Stock Pot	61232C	1 ea	9.10/1.89
61240 <b>Δ C</b>	40 qt Standard Weight Stock Pot	61240C	1 ea	9.80/2.30
61260 <b>Δ C</b>	60 qt Standard Weight Stock Pot	61260C	1 ea	13.80/3.40
61280 <b>Δ C</b>	80 qt Standard Weight Stock Pot	61280C	1 ea	15.90/4.27
61200 <b>Δ C</b>	100 qt Standard Weight Stock Pot	61200C	1 ea	17.60/4.94
<b>Standard Weight Braziers</b>				
61115 <b>Δ C</b>	15 qt Standard Weight Brazier	61232C	1 ea	9.24/0.81
61120 <b>Δ C</b>	20 qt Standard Weight Brazier	61120C	1 ea	11.66/0.92
61125 <b>Δ C</b>	25 qt Standard Weight Brazier	61125C	1 ea	11.66/0.92
61130 <b>Δ C</b>	30 qt Standard Weight Brazier	61130C	1 ea	13.64/1.59
<b>Standard Weight Sauté Pans</b>				
61905 <b>Δ C</b>	5 qt Sauté Pan	61905C	6 ea	18.00/2.18
61907 <b>Δ C</b>	7 qt Sauté Pan	61907C	6 ea	15.00/2.40
<b>Standard Weight Straight Sided Sauce Pans</b>				
61302 <b>Δ C</b>	2.5 qt Standard Weight Sauce Pan	61302C	6 ea	14.00/2.01
61305 <b>Δ C</b>	5 qt Standard Weight Sauce Pan	61305C	6 ea	19.00/4.66
61308 <b>Δ C</b>	8.5 qt Standard Weight Sauce Pan	61308C	6 ea	28.87/3.50
<b>Standard Weight Tapered Sauce Pans</b>				
61702 <b>Δ C</b>	2.5 qt Tapered Sauce Pan	61702C	6 ea	9.50/0.78
61704 <b>Δ C</b>	4.5 qt Tapered Sauce Pan	61704C	6 ea	12.80/3.17
61707 <b>Δ C</b>	6 qt Tapered Sauce Pan	61707C	6 ea	17.00/2.92
61708 <b>Δ C</b>	8.5 qt Tapered Sauce Pan	61708C	6 ea	20.70/3.82
61710 <b>Δ C</b>	10 qt Tapered Sauce Pan	61710C	6 ea	22.00/4.87
<b>Sectional Pasta Cooker</b>				
60100PC	Quarter Size Sectional Pasta Cooker includes 20 qt pot with 4 inserts	—	1 ea	12.00/1.80
60102	20 qt Pot for Pasta Cooker Combination	—	2 ea	10.00/1.79
60101	Quarter Size Perforated Insert	—	4 ea	7.00/1.80

NSF Listed products are designated with a **Δ**

Cash 'N Carry products are designated with a **C**

# COOKWARE

## Heavy-Duty Covers

- Carlisle's unique reinforced design resists dents and holds its shape better than old-fashioned lids
- Extra heavy-duty covers are fabricated from hard 3004 aluminum to stand up to the toughest foodservice environment
- Open looped handles are securely riveted
- NSF Listed



## Domed Fry Pan Covers

- Domed covers fit snugly on the pans creating a self-basting effect by allowing moisture to condense and return to the pan
- Strong welds on handle insure long life
- NSF Listed



60921

## Double Boiler

- Heavy-duty construction and extra thick base for superior thermal conductivity; prevents scorching of delicate sauces, chocolate, and more
- Traditional weight satin finish cookware
- Durable rolled edge with sanitary open bead
- Double boiler includes stock pot, insert and cover; inserts are also available separately
- NSF Listed



60103

## Burger Cover

- Accelerates cooking on grill tops
- Aluminum cover provides quick and even heating for thorough cooking
- Helps retain flavor and moisture
- Heat resistant knob is cool to the touch

601002



601028  
601029

## Baskets

### Stainless Steel

- Rust free 18-8 stainless steel is perfect for cooking or reheating single servings of pasta
- 18-8 baskets can also be used for small batch frying or breading
- Stainless baskets feature cool-touch handles and heavy-duty chrome steel hook for draining basket

### Chrome Plated

- Chrome plated nickel steel basket is designed for small batch deep frying
- Chrome plated nickel basket not intended for use in water

Prod No	Description	Cover	Pack	Cs Wt/Cube
<b>Heavy-Duty Covers</b>				
61120C $\Delta$	Cover for 61120	—	6 ea	12.80/1.71
61125C $\Delta$	Cover for 61225	—	6 ea	14.80/1.96
61130C $\Delta$	Cover for 61130	—	6 ea	19.60/2.75
61200C $\Delta$	Cover for 61200	—	6 ea	19.58/2.72
61210C $\Delta$	Cover for 61210 & 61212	—	6 ea	4.40/0.52
61216C $\Delta$	Cover for 61216	—	6 ea	6.00/0.63
61220C $\Delta$	Cover for 61220	—	6 ea	6.00/0.69
61224C $\Delta$	Cover for 61224	—	6 ea	6.00/0.82
61232C $\Delta$	Cover for 61232 & 61115	—	6 ea	10.60/1.32
61240C $\Delta$	Cover for 61240	—	6 ea	11.20/1.45
61260C $\Delta$	Cover for 61260	—	6 ea	14.80/1.96
61280C $\Delta$	Cover for 61280	—	6 ea	17.00/2.36
61302C $\Delta$	Cover for 61302	—	6 ea	3.10/0.33
61305C $\Delta$	Cover for 61305	—	6 ea	4.20/0.48
61308C $\Delta$	Cover for 61308	—	6 ea	5.10/0.55
61702C $\Delta$	Cover for 61702	—	6 ea	3.10/0.33
61704C $\Delta$	Cover for 61704	—	6 ea	3.80/0.42
61707C $\Delta$	Cover for 61707	—	6 ea	5.10/0.55
61708C $\Delta$	Cover for 61708	—	6 ea	5.30/0.59
61710C $\Delta$	Cover for 61710	—	6 ea	6.00/0.78
61905C $\Delta$	Cover for 61905	—	6 ea	6.00/0.69
61907C $\Delta$	Cover for 61907	—	6 ea	8.30/0.75
<b>Domed Fry Pan Covers</b>				
60907C $\Delta$	7" Dome Fry Pan Cover	—	6 ea	3.10/0.30
60908C $\Delta$	8" Dome Fry Pan Cover	—	6 ea	4.00/0.38
60910C $\Delta$	10" Dome Fry Pan Cover	—	6 ea	5.55/0.57
60912C $\Delta$	12" Dome Fry Pan Cover	—	6 ea	8.00/0.72
60914C $\Delta$	14" Dome Fry Pan Cover	—	3 ea	5.85/0.35
<b>Burger Cover</b>				
60103	6" Burger Cover	—	12 ea	4.00/0.81
<b>Double Boilers</b>				
60921 $\Delta$	12 qt Double Boiler with 12 qt Insert	—	1 ea	10.00/1.72
60934 $\Delta$	20 qt Double Boiler with 16 qt Insert	—	1 ea	13.00/2.17
<b>Stainless Steel Mesh Baskets</b>				
601028	8.75" 18-8 SS Fryer Basket	—	12 ea	18.00/2.92
601029	9.75" 18-8 SS Fryer Basket	—	12 ea	20.00/2.92
601031	11.5" 18-8 SS Fryer Basket	—	12 ea	26.00/2.92
<b>Chrome Plated Mesh Baskets</b>				
601000	8.75" Mesh Fryer Basket	—	12 ea	17.00/1.66
601001	9.75" Mesh Fryer Basket	—	12 ea	19.00/2.41
601002	11.5" Mesh Fryer Basket	—	12 ea	25.00/3.10
601003	13.5" Mesh Fryer Basket	—	12 ea	39.00/4.22

NSF Listed products are designated with a  $\Delta$

# BAKEWARE

## Roast & Bake Pans

- Extra large, heavy-duty sizes capable of holding multiple roasts, hams, or turkeys
- Reinforced rolled edge for added strength
- 60306, 601923 have securely riveted drop handles for easier and safer lifting of heavy loads
- NSF Listed



601922



60306



601923



## Commercial Weight Double Roasters

- Commercial weight aluminum roasters are equipped with 2 steel reinforced bands for extra heavy usage
- Pans feature seamless drawn sanitary open bead
- Covers and bases can also be used individually as open roasters
- Full size pans fit standard baker's racks
- Drop handles are securely riveted
- 60345's fabricated lugs hold top securely in place
- NSF Listed



60346



60344



60345

## Aluminized Steel Baking Pans

- Aluminized steel pans are the ultimate choice for baking breads, cupcakes, muffins, and cakes
- The special finish provides greater heat transfer for lower baking temperatures, shorter baking time, and better looking, more uniform baked goods
- Corrosion-resistant material withstands temperatures in excess of 700°F
- Individual seamless cups are locked into heavy frames



601837  
601834  
601840  
601829

606903  
606902



### Bun Pans & Sheet Pans

- Sturdy bun pans for baking, transporting, and displaying cookies, bread, and pastries
- Aluminum surface allows even browning of foods
- Manufactured from extra hard, tempered aluminum alloy with galvanized steel wire reinforced bead
- Tapered shape stacks for storage
- Use with Icing Grates shown on page 152



601825  
601828  
601824

### Aluminized Steel Bread Pans & Pullman Pans

- Aluminized steel pans are the ultimate choice for baking breads and cakes



604144  
604174  
602164

Prod No	Description	Pack	Cs Wt/Cube
<b>Roast &amp; Bake Pans</b>			
60306 $\Delta$	21 ga, 8 qt Bake Pan with Drop Handles; 17" x 11" x 2.5"	6 ea	27.55/2.97
601922 $\Delta$	17 ga, 13.5 qt Bake Pan; 26" x 18" x 2.25"	4 ea	51.54/1.79
601923 $\Delta$	17 ga, 19 qt Bake Pan with Drop Handles; 26" x 18" x 3.5"	6 ea	40.04/2.58
<b>Commercial Weight Double Roasters</b>			
60346 $\Delta$	Double Roaster; 24" x 18" x 9" (includes 60344 & 60345)	1 ea	22.00/2.12
60344 $\Delta$	16 ga, 26 qt Roast Pan (use as cover); 24" x 18" x 4.5"	2 ea	37.70/3.48
60345 $\Delta$	16 ga, 26 qt Roast Pan (use as base); 24" x 18" x 4.5"	2 ea	38.14/3.69
<b>Aluminized Steel Muffin Pans</b>			
601829	24 Cup/1.75 oz Mini-Muffin/Cupcake Pan	6 ea	24.00/0.61
601830	12 Cup/3.5 oz Heavy-Duty Cupcake Pan	12 ea	21.00/0.58
601840	24 Cup/3.5 oz Heavy-Duty Cupcake Pan	6 ea	32.00/0.79
601834	12 Cup/4 oz Large Cup Cupcake Pan	6 ea	9.15/0.55
601837	12 Cup/6 oz Extra Large Cup Cupcake Pan	6 ea	27.00/0.90
<b>Aluminized Steel Mini Loaf Pans</b>			
606902	6 Loaf Mini Loaf Pan	6 ea	22.00/1.04
606903	12 Loaf Mini Loaf Pan	6 ea	24.00/1.16
<b>Bun Pans &amp; Sheet Pans</b>			
601825	18 ga, Full Size Sheet Pan; 25.75" x 17.81" x 1.13"	12 ea	39.00/1.59
601826	16 ga, Heavy-Duty Full Size Sheet Pan; 25.75" x 17.81" x 1.13"	12 ea	46.00/1.59
601824	18 ga, Half Size Bun Pan; 17.81" x 12.88" x 1"	12 ea	21.60/0.93
601828	18 ga, Perforated Full Size Sheet Pan; 25.75" x 17.81" x 1.13"	12 ea	36.00/1.59
<b>Aluminized Steel Bread Pans</b>			
604144	1 lb Loaf Bread Pan	12 ea	14.00/0.60
604174	1.75 lb Loaf Bread Pan	12 ea	17.00/1.39
<b>Aluminized Steel Pullman Pans</b>			
602164	32 oz Pullman Pan with Cover	12 ea	34.00/2.40
602164C	Pullman Pan Cover (only)	12 ea	8.00/0.25
602164P	Pullman Pan (only)	12 ea	26.00/2.19

NSF Listed products are designated with a  $\Delta$

# BAKEWARE



602424



60322  
60324

## Heavy-Duty Muffin Pan

- Heavy-duty muffin pan has seamless cups locked into heavy aluminum frame
- Holds up in busy foodservice environments

## Pie Pans

- Heavy 18 gauge, natural finish aluminum spreads heat evenly for better baking



6041

6044



601306  
601642

## Springform Pans

- Use for cheesecakes, batter cakes, and other specialty items
- Heavy gauge, natural finish aluminum distributes heat evenly for better baking
- Heavy-duty frame has quick-release, spring-form sides for easy removal and quick clean-up

## Icing Grates

- Use graters for thawing foods or cooling and icing cakes, cookies, and desserts
- 601306 welded icing grate fits full size bun pans and is made of nickel plated steel
- 601642, 601647 mesh icing graters are made of heavy steel mesh wire

Prod No	Description	Pack	Cs Wt/Cube
<b>Heavy-Duty Muffin Pan</b>			
602424	24 Cup/3 oz Aluminum Muffin Pan	12 ea	32.00/1.82
<b>Pie Pans</b>			
60322	9" Pie Pan – 1.25" Deep	24 ea	12.00/0.82
60324	10" Pie Pan – 1.31" Deep	24 ea	14.00/0.82
<b>Springform Pans</b>			
6041	8" Springform Pan	6 ea	5.00/1.21
6042	9" Springform Pan	6 ea	5.00/1.21
6043	10" Springform Pan	6 ea	6.00/1.33
6044	12" Springform Pan	6 ea	7.00/2.55
<b>Icing Grates</b>			
601306	Icing Grate, Fits 601825, 601826, 601828 Bun Pan	12 ea	38.00/1.01
601642	Mesh Icing Grate, Fits 601824 Bun Pan	12 ea	18.00/1.21
601647	Mesh Icing Grate, Fits 601825, 601826, 601828 Bun Pan	12 ea	32.00/1.08



# KITCHEN ACCESSORIES

Stock your kitchen with Carlisle heat lamps, cutting boards, scoops, measuring cups and more! Our products add the versatility you want while supporting the need to get your work done efficiently and effectively every day.

<b>Product</b>	<b>Page</b>
Aprons . . . . .	172
Basting Brushes . . . . .	160-162
Batter Pan . . . . .	166
Board & Brush Racks . . . . .	154 & 155
Brushes . . . . .	154 & 155, 160-162
Colanders . . . . .	168
Cutting Board & Accessories . . . . .	154 & 155
Dishers . . . . .	164
Dredges/Powder Cans . . . . .	169
Flexiglow . . . . .	156
Food Preparation Brushes . . . . .	162
French Whips . . . . .	170
Heat Lamps . . . . .	156
High Heat Utensils . . . . .	170
Ice Totes & Containers . . . . .	159
Ladles . . . . .	165
Measure Misers . . . . .	166
Measures	
Commercial Measures . . . . .	164
Measuring Cups Set . . . . .	164
Measuring Cup . . . . .	164
Measuring Spoons . . . . .	164
Portioning Cups . . . . .	163
Meat Tenderizer . . . . .	172

<b>Product</b>	<b>Page</b>
Mixing Bowls . . . . .	166 & 167
One Gallon Container . . . . .	163
Order Racks . . . . .	158
Order Wheels . . . . .	158
Paddle Scrapers . . . . .	171
Pastry Brushes . . . . .	160-162
Peeler, Stainless Steel . . . . .	172
Scoops . . . . .	158
Scrapers . . . . .	170
Server, Tortilla . . . . .	157
Shaker/Dredge . . . . .	169
Spaghetti Strainers . . . . .	168
Shovels . . . . .	172
Skimmers, Wire Mesh . . . . .	168
Spatulas . . . . .	170 & 171
Spoons, High Heat . . . . .	170
Steak Weight . . . . .	172
Ticket Wheels . . . . .	158
Timer . . . . .	172
Tongs . . . . .	168
Tortilla Server . . . . .	157
Turner, High Heat . . . . .	170
Utility Brush . . . . .	162
Wire Mesh Skimmers . . . . .	168

# CUTTING BOARDS & ACCESSORIES

## Sparta® Spectrum® Cutting Boards & Accessories

- Sparta Spectrum Color-Coded Products are a key group of CCP (Critical Control Point™) Products designed to promote safe food handling and help prevent hazardous cross-contamination
- Help meet HACCP guidelines by promoting segregated food prep for different foods
- HDPE (High Density Polyethylene) construction offers a durable cutting surface, and a high stability, warp-resistant cutting board
- Rounded corners and edges for easier, safer handling
- Hygienic surface texture on boards prevents deep cuts and is easy to clean
- Contact your local Carlisle Sales Representative for custom sizing
- NSF Listed; dishwasher safe



## Sparta Cutting Board Accessories

- Carlisle's Cutting Board Accessories support a complete HACCP System

### Board & Brush Racks

- All products are dishwasher safe and easy to clean



10889WC Laminated Spectrum Wall Chart for quick color usage reference



NSF mark is permanently stamped on board to meet health department requirements

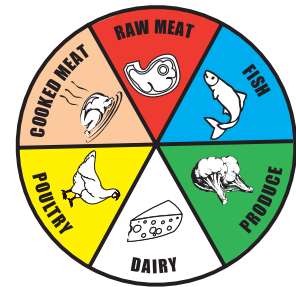

Produce

Sparta color-coded cutting boards promote safe food handling



Dairy

Color-coding to food type helps prevent hazardous cross-contamination



Fish

Use Sparta brushes for a complete HACCP system





11878



11789



11799



11801

**Board & Brush Racks**

- Organizes up to six 24" x 24" x 1" cutting boards and six cutting board brushes
- Vinyl coated steel rack provides secure grip and will not scratch stainless steel counter tops

**Sparta Spectrum Cutting Board Brushes**

- Sparta Spectrum Cutting Board Brush Assortment Pack includes one each of our Sparta Spectrum Color-Coded Cutting Board Brushes

**Griptime Mat**

- Textured mat holds boards in place
- NSF Listed; dishwasher safe

**Spectrum Wall Chart**

- Quick reference laminated chart in both English and Spanish
- Included with all assortment cutting board packs
- Also sold separately

**Cutting Board Scraper/Refinisher Tool**

- Removes cuts from cutting boards
- Saves money on fewer replacement cutting boards
- Dishwasher safe



Assorted(00)



White(02)



Black(03)



Yellow(04)



Red(05)



Green(09)



Blue(14)



Tan(25)



Stainless Steel(44)

Prod No	Description	Color	Pack	Cs Wt/Cube
<b>Cutting Boards</b>				
10901 <span style="color: blue;">▲</span>	6" x 9" x .5" White Board	02	6 ea	5.50/0.13
10880 <span style="color: blue;">▲</span>	12" x 18" x .5" Assortment Pack	00	1 pk	16.45/0.52
10881 <span style="color: blue;">▲</span>	12" x 18" x .5" White Board	02	6 ea	22.70/0.45
10882 <span style="color: blue;">▲</span>	12" x 18" x .5" Color Board	04, 05, 09, 14, 25	6 ea	17.05/0.51
12881 <span style="color: blue;">▲</span>	12" x 18" x .75" White Board	02	3 ea	17.65/0.37
12882 <span style="color: blue;">▲</span>	12" x 18" x .75" Color Board	04, 05, 09, 14, 25	3 ea	17.65/0.37
10883 <span style="color: blue;">▲</span>	15" x 20" x .5" Assortment Pack	00	1 pk	23.25/0.73
10884 <span style="color: blue;">▲</span>	15" x 20" x .5" White Board	02	6 ea	32.50/0.68
10885 <span style="color: blue;">▲</span>	15" x 20" x .5" Color Board	04, 05, 09, 14, 25	6 ea	23.60/0.70
12886 <span style="color: blue;">▲</span>	15" x 20" x .75" White Board	02	3 ea	24.00/0.46
12887 <span style="color: blue;">▲</span>	15" x 20" x .75" Color Board	04, 05, 09, 14, 25	3 ea	24.00/0.46
10886 <span style="color: blue;">▲</span>	18" x 24" x .5" Assortment Pack	00	1 pk	33.40/1.04
10887 <span style="color: blue;">▲</span>	18" x 24" x .5" White Board	02	6 ea	31.20/1.04
10888 <span style="color: blue;">▲</span>	18" x 24" x .5" Color Board	04, 05, 09, 14, 25	6 ea	33.90/1.04
12891 <span style="color: blue;">▲</span>	18" x 24" x .75" White Board	02	3 ea	34.65/0.69
12892 <span style="color: blue;">▲</span>	18" x 24" x .75" Color Board	04, 05, 09, 14, 25	3 ea	36.00/0.67
10897 <span style="color: blue;">▲</span>	24" x 24" x .5" White Board	02	6 ea	55.00/1.25
12901 <span style="color: blue;">▲</span>	24" x 24" x .75" White Board	02	3 ea	45.75/0.90
<b>Board &amp; Brush Racks</b>				
11879	Professional Board & Brush Rack	03	1 ea	6.40/0.73
11878 <span style="color: blue;">▲</span>	CCP Board & Brush Rack	03	1 ea	1.55/0.43
<b>Sparta Spectrum Cutting Board Brushes</b>				
41342	6" Brush Assortment Pack	00	1 st	3.00/0.23
<b>Cutting Board Scraper/Finisher Tool</b>				
11789	Cutting Board Refinisher	02	12 ea	3.80/0.42
11799	Replacement Refinisher Blades (2 pk)	44	12 pk	1.50/0.04
<b>Griptime Mat</b>				
11801 <span style="color: blue;">▲</span>	Griptime 13" x 18" Cutting Board Mat	14	6 ea	6.43/0.62
<b>Spectrum Wall Chart</b>				
10889WC	Spectrum Color-Coded Cross-Contamination Wall Chart	00	6 ea	1.15/0.22

NSF Listed products are designated with a ▲

# HEAT LAMPS

## Heat Lamps

- Wide selection of heat lamps for both front-of-the-house buffet service and back-of-the-house temperature retention

### Flexiglow™

- Spun aluminum shade with flared rim for added strength
- Shade is drilled for increased heat dissipation
- Optional NSF Listed maple cutting board and drip pan is perfect for a front-of-the-house carving station
- Meets Standard Electrical Specifications shown on facing page
- Rated UL recognized

### Dual Arm Flexiglow

- Two flex arms provide heating for separate products
- Vinyl-coated arms help keep unit sanitary
- Includes two 250-watt Red bulbs

### Single Arm Flexiglow

- Switch located away from the heat source
- Includes 250 watt Red bulb



HL8285GB



HL8185



HL8285



HLA20



HL8195B

Replacement Parts shown on page 303



### Cash 'N Carry

Selected products also available in a cash 'n carry pack. See page 277.



HL7237PS



### Two Bulb Adjustable

- Adjustable arm for different heat settings
- Spun aluminum shades with flared rim for added strength and more even heat dissipation
- Ceramic insulated sockets with nickel plated contacts to prevent fusing
- Meets Standard Electrical Specifications shown on facing page
- On/off switch mounted on arm away from heat zone
- Includes two 250-watt Clear bulbs
- UL & CSA listed

Heat Lamps shown are for U.S. use only. Ask your Carlisle Customer Service Representative for details on ordering Heat Lamps for international use.

# TORTILLA SERVERS



0717



## 12" Insulated Tortilla Server

- Unique Aztec design is at home in any traditional Mexican or Tex-Mex setting
- Large 12" diameter is great for holding burrito sized tortillas and prepping wraps
- Thick walled polypropylene material helps keep food warm
- Microwaveable, safe for temperatures up to 190° F
- See page 52 for a complete listing of tortilla servers
- Servers are stackable
- NSF Listed; dishwasher safe



Aluminum(00)

Black(03)

Red(05)

Forest Green(08)

Blue(14)

Gold(21)

Terra Cotta(29)

Prod No	Description	Color	Pack	Cs Wt/Cube
<b>Flexiglow Heat Lamps</b>				
HL8285 <span style="color: blue;">▲</span>	Dual Arm Flexiglow, Aluminum, 24" Arm	00	1 ea	8.80/3.00
HL8285G <span style="color: blue;">▲</span>	Dual Arm Flexiglow, Gold, 24" Arm	21	1 ea	8.80/3.00
HL8285B* <span style="color: blue;">▲</span>	Dual Arm Flexiglow with Board & Pan, Aluminum, 24" Arm	00	1 ea	30.25/3.91
HL8285GB* <span style="color: blue;">▲</span>	Dual Arm Flexiglow with Board & Pan, Gold, 24" Arm	21	1 ea	31.00/3.91
HL8185 <span style="color: blue;">▲</span>	Flexiglow, Aluminum, 24" Arm	00	1 ea	6.25/1.55
HL8185G <span style="color: blue;">▲</span>	Flexiglow, Gold, 24" Arm	21	1 ea	7.25/1.55
HL8185C	Flexiglow, Aluminum, 24" Arm, Includes Clamp	00	1 ea	7.95/1.55
HL8185GC	Flexiglow, Gold, 24" Arm, Includes Clamp	21	1 ea	26.00/1.55
HL8185B* <span style="color: blue;">▲</span>	Flexiglow with Board & Pan, Aluminum, 24" Arm	00	1 ea	26.65/3.91
HL8185GB* <span style="color: blue;">▲</span>	Flexiglow with Board & Pan, Gold, 24" Arm	21	1 ea	26.65/3.91
HLA20	Flexiglow Clamp (8100 & 8200 Series)	—	1 ea	1.70/0.22
HL8195 <span style="color: blue;">▲</span>	Flexiglow Aluminum, 39" Arm	00	1 ea	7.50/2.33
HL8195B* <span style="color: blue;">▲</span>	Flexiglow with Board, Aluminum, 39" Arm	00	1 ea	27.65/3.91
<b>Two Bulb Adjustable Heat Lamp</b>				
HL7237 <span style="color: blue;">▲</span> <span style="color: green;">■</span>	Two Bulb Free Standing Adjustable Heat Lamp	00	1 ea	9.40/4.99
HL7237PS	Two Bulb Free Standing Adjustable Heat Lamp with 13" x 21" SS Pan & Screen	00	1 ea	14.00/4.99
<b>12" Insulated Tortilla Server</b>				
0717 <span style="color: blue;">▲</span>	12" Tortilla Server	03, 05, 08, 14, 29	6 ea	21.00/2.11
0707 <span style="color: blue;">▲</span>	12" Replacement Lid	03, 05, 08, 14, 29	6 ea	8.00/0.76

NSF Listed products are designated with a ▲

Cash 'N Carry products are designated with a ■

\* Includes 18" x 26" drip pan and 16" x 24" maple cutting board

Note: To allow for choice of lamp placement, holes in board are not pre-drilled

Note: HL8185B, HL8185GB, HL8195, HL8195B, HL8285, HL8285G, HL8285B, HL8285GB can be shipped UPS/FedEx Ground at oversize cost

Note: Heat Lamps sold or shipped outside the U.S. do not include a plug or bulb(s)

### Standard Electrical Specifications for Carlisle Heat Lamps

- Sockets are ceramic insulated and furnished with a nickel-plated copper screw shell and contact point to prevent fusing
- Internal wiring is braided and silicone covered and rated 200° C
- Durable 16 gauge external wiring with molded three-prong plug
- All switches are either "T" or "L" rated and surpass minimum requirements
- All switches are located out of the heat zone
- Designed to operate on 110-120 volt AC service; wiring will accommodate 250 volt AC service
- Heat lamps have one year warranty against defects in materials and workmanship

# ORDER WHEELS AND RACKS



3816MP



3812CM



3812CH



3816WH

## Order Wheels

- Keeps orders in clear view during preparation
- Rugged stainless steel construction
- Unique ball/spring clips for easy, one-handed check placement
- Custom length (381EX) extensions available for counter and ceiling mount models

### Counter Mount Model

- Wheel mounts to any counter
- 9" extension & plate included

### Ceiling Hung Model

- Square "CH" plate on top of axle mounts to ceiling with 4 screws

### Wall Mounted Model

- Wheel mounts to any wall
- Extension & plate included

### Pedestal Model

- Heavy chrome 10" round base won't tip
- Rubber footprint prevents slipping and protects counter tops
- Includes 9" extension for adjustable height

Replacement Parts shown on page 303



38240A



38360

## Slide Order Racks

- Ball-bearing action provides clean look & one-handed sliding action
- Choose from rugged stainless steel or economical aluminum options
- Custom lengths are available by special order

## Scoops

### Metal Scoops

- Heavy-duty scoops have easy to hold pistol-grip handles with clearly marked capacities

### Polycarbonate Scoops

- Easy-grip plastic handle doesn't transfer cold
- Features a hole for hanging or tying to a container
- Durable polycarbonate material
- NSF Listed; dishwasher safe



4364

4332

4306

606086

606055

606040





12875



12877

### IceMaster™ Ice Transport Tote

- Sturdy, high-impact material is less susceptible to cracking and breaking than other totes
- Includes molded-on Comfort Grip™ handle and side helper handle for emptying
- Helper handle doubles as drain hook
- Securely attaches upside down to edge of wire shelving or locks into mounting bracket to drain tote
- Optional mounting bracket can be attached to walls or the side of an ice bin
- Lid also available; protects against contaminants
- NSF Listed

### Ice Only Container

- Safely and easily transports small loads of ice
- Perfect for filling food bars or other iced food displays, ice bins on portable bars, or even automatic ice dispensers at self-serve beverage stations
- Heavy-duty construction and ergonomic Comfort Curve™ handles provide easy handling; deep hand holds on base for controlled tipping
- Lids are reinforced and have snap down tab lock
- Imprinted on two sides in both English & Spanish
- NSF Listed



341010ICE



White(02)



Clear(07)



Blue(14)

Prod No	Description	Color	Pack	Cs Wt/Cube
<b>Order Wheels</b>				
3812MP	12 Clip, 14" Portable Order Wheel	—	1 ea	10.60/1.30
3816MP	16 Clip, 18" Portable Order Wheel	—	1 ea	12.05/1.57
3820MP	20 Clip, 23" Portable Order Wheel	—	1 ea	13.75/2.49
3812CM	12 Clip, 14" Counter Mount Order Wheel	—	1 ea	3.80/0.61
3812CH	12 Clip, 14" Ceiling Hung Order Wheel	—	1 ea	3.20/0.61
3816CH	16 Clip, 18" Ceiling Hung Order Wheel	—	1 ea	4.45/1.13
3820CH	20 Clip, 23" Ceiling Hung Order Wheel	—	1 ea	4.95/1.30
3816WH	16 Clip, 18" Wall Mounted Order Wheel with 9" Extension	—	1 ea	5.20/1.13
<b>Slide Order Racks</b>				
38360	36" Stainless Steel Slide Order Rack	—	3 ea	8.55/0.30
38480	48" Stainless Steel Slide Order Rack	—	3 ea	11.50/0.51
38180A	18" Aluminum Slide Order Rack	—	3 ea	3.10/0.11
38240A	24" Aluminum Slide Order Rack	—	3 ea	4.30/0.20
38360A	36" Aluminum Slide Order Rack	—	3 ea	6.70/0.32
38480A	48" Aluminum Slide Order Rack	—	3 ea	8.80/0.51
<b>Scoops</b>				
606040	38 oz Solid Cast Aluminum Scoop	—	12 ea	10.32/0.54
606055	58 oz Solid Cast Aluminum Scoop	—	12 ea	19.87/0.74
606086	85 oz Solid Cast Aluminum Scoop	—	12 ea	20.76/1.15
4306 Δ	6 oz Polycarbonate Scoop	07	12 ea	2.60/0.33
4332 Δ	32 oz Polycarbonate Scoop	07	12 ea	5.15/0.82
4364 Δ	64 oz Polycarbonate Scoop	07	6 ea	4.05/0.84
<b>IceMaster Ice Transport Tote &amp; Accessories</b>				
12875 Δ	IceMaster Ice Transport	02	2 ea	7.50/2.64
12876	IceMaster Lid	14	1 ea	0.29/0.10
12877	IceMaster Wall Bracket	14	1 ea	0.11/0.01
<b>Ice Only Container &amp; Lid</b>				
341010ICE Δ	10 gal Ice Only Container	02	6 ea	16.50/5.45
341011	10 gal Lid	02	6 ea	5.50/0.77

NSF Listed products are designated with a Δ

# PASTRY & BASTING BRUSHES

## Sparta® Pastry Brushes

- The finest commercial brushes of their kind – bar none
- Top choice of discriminating professional chefs the world over for decades
- Offer the performance, delicate touch, and long-lasting value by which all others are judged

## Sparta Chef Series Brushes

- Professional, high-quality lacquered hardwood handles with brown plastic ferrules are the choice of top chefs
- Bristles are epoxy-set to ferrules to provide superior bristle retention and to prevent bacteria harboring air pockets

## Sparta Chef Series Pastry Brushes

- Soft flagged, white nylon bristles have high fluid retaining capacity and provide a soft touch to delicate pastries



## Special Food Safety Construction

Other Brands		<p>Epoxy-set ferrules on all Sparta Pastry/Basting Brushes are especially designed for foodservice use; eliminating hazardous bacteria traps commonly found in other brushes. Sparta Pastry/Basting Brushes are available in a wide range of sizes and styles.</p>
Chef Series		



## Sparta Chef Series Croissant Brush

- Extra long bleached boar bristles for use on the most delicate of pastries and foods

## Sparta Chef Series Basting Brushes

- The professional's choice for use in basting meats and poultry
- Durable sterilized, double-boiled, bleached boar bristles are water resistant
- Withstands temperatures of up to 500°F



Note: Basting brushes should not be cleaned in dishwashers. Brushes should be dipped in a commercial cleaning solution and rinsed.



Hook hangs on side of crock or elevates bristles off counter tops



### Sparta Meteor® Pastry/Basting Brushes

- "Molded into-the-handle" hook hangs on lip of crocks and containers to prevent bristle burn, melt or distortion caused by resting against hot pan bottoms
- Use hook to elevate bristles off of counter tops to keep bristles clean
- Soft flagged bristles are molded into handle to prevent bacteria harboring air pockets
- Available with white nylon bristles or double-boiled, bleached, sterilized premium boar bristles



For usage information on these and other brushes included in our Key 21 Brushes Set, check out our Kitchen Brush Guide on pages 204 & 205 in this catalog.

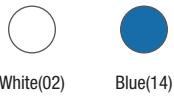

Prod No	Description	Color	Pack	Cs Wt/Cube
<b>Sparta Chef Series Pastry Brushes</b>				
40395	1" Wide Brush with Nylon Bristles	—	12 ea	1.06/0.05
40396	1.5" Wide Brush with Nylon Bristles	—	12 ea	1.36/0.05
40397	2" Wide Brush with Nylon Bristles	—	12 ea	1.70/0.08
40398	3" Wide Brush with Nylon Bristles	—	12 ea	2.90/0.17
40399	4" Wide Brush with Nylon Bristles	—	12 ea	4.36/0.23
40400	1" Round Brush with Nylon Bristles	—	12 ea	2.15/0.13
<b>Sparta Chef Series Croissant Brush</b>				
40377	1.5" Wide Brush with Boar Bristles	—	12 ea	3.00/0.13
<b>Sparta Chef Series Basting Brushes</b>				
40370	12" Handle with 2" Wide Brush with Boar Bristles	—	12 ea	2.95/0.23
40371	12" Handle with 4" Wide Brush with Boar Bristles	—	12 ea	6.00/0.65
40372	1" Wide Flat Brush with Boar Bristles	—	12 ea	1.00/0.05
40373	1.5" Wide Flat Brush with Boar Bristles	—	12 ea	1.36/0.05
40374	2" Wide Flat Brush with Boar Bristles	—	12 ea	1.75/0.08
40375	3" Wide Flat Brush with Boar Bristles	—	12 ea	3.10/0.17
40376	4" Wide Flat Brush with Boar Bristles	—	12 ea	4.65/0.23
40380	1" Round Brush with Boar Bristles	—	12 ea	2.26/0.13
<b>Sparta Meteor Pastry/Basting Brushes</b>				
40378	2" Wide Brush with Boar Bristles	—	12 ea	1.96/0.13
40379	3" Wide Brush with Boar Bristles	—	12 ea	2.50/0.17
40401	2" Wide Brush with Nylon Bristles	02, 14	12 ea	2.00/0.13
40402	3" Wide Brush with Nylon Bristles	02, 14	12 ea	9.00/0.76

# PASTRY & BASTING BRUSHES



## Sparta® Galaxy™ Pastry/Basting Brushes

- One piece plastic handles are easy to clean
- Bristles are epoxy-set to ferrules to prevent bacteria harboring air pockets
- Available with soft flagged nylon bristles or double-boiled, bleached, sterilized premium boar bristles
- Select brushes also available with blue nylon bristles for added contrast in working with white frostings or other white foods



### Cash 'N Carry

Selected products also available in a cash 'n carry pack. See page 284.

## Silicone Basting Brush

- Unique bristle design carries and spreads liquid better than ordinary Silicone basting brushes
- Red color-coding for high heat cooking applications
- Withstands temperatures up to 500° F
- Convenient molded-in hanging hook grabs pan edges to keep brush from sliding in
- Stain and odor resistant
- Dishwasher safe

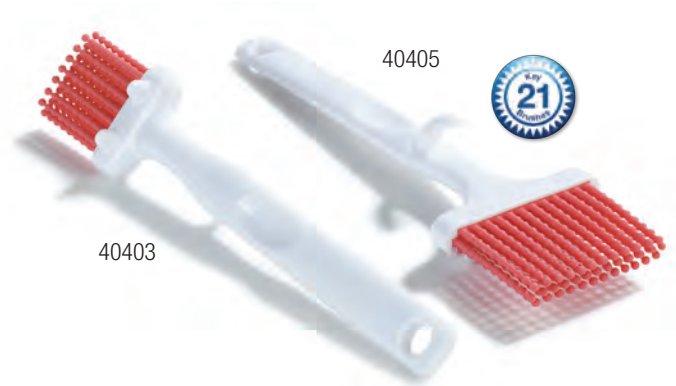

## Sparta Food Preparation Brushes

### Potato Brush

- Patented brush has stiff polyester bristles for aggressive cleaning along with a unique “scraper edge” grip for removing hard to reach blemishes on potatoes and other firm vegetables

### Vegetable Brush

- Round loop construction, straight handle with firm bristles

### Sparta Utility Brush

- Loop construction and straight handle brush performs a variety of kitchen cleaning functions





### Portioning Cups

- Made of durable, break-resistant polycarbonate
- Scoop or transfer ice, liquids, or any bulk item
- Features flat sides for efficient scooping on the bottom of bins, food pans, or other storage containers
- Unique U-shaped handle helps keep hands away from food contact areas while scooping
- Sizes are color coded for quick and easy identification
- NSF Listed; dishwasher safe

### One Gallon Container

- Ideal for mixing batters, dressings, and drinks
- Assorted color toggle lids allow easy access for quick open and close action and color identification
- Tight sealing lid protects against spills
- Durable translucent polypropylene material makes it easy to see contents
- U.S. and metric measurements printed on side panels
- NSF Listed; dishwasher safe



Prod No	Description	Color	Pack	Cs Wt/Cube
<b>Sparta Galaxy Pastry/Basting Brushes</b>				
362723	3" Wide Brush with Nylon Bristles	02	12 ea	2.50/0.27
362743	3" Wide Brush with Boar Bristles	02	12 ea	2.25/0.27
36270	1" Round Brush with Boar Bristles	02	12 ea	2.52/0.09
40390	1.5" Wide Flat Brush with Nylon Bristles	02	12 ea	1.00/0.05
40391	2" Wide Flat Brush with Nylon Bristles	02, 14	12 ea	1.50/0.13
40392	3" Wide Flat Brush with Nylon Bristles	02, 14	12 ea	1.90/0.13
40393	4" Wide Flat Brush with Nylon Bristles	02, 14	12 ea	2.90/0.16
40394	1" Round Brush with Nylon Bristles	02	12 ea	2.00/0.10
40790	1.5" Wide Flat Brush with Boar Bristles	02	12 ea	1.36/0.05
40791	2" Wide Flat Brush with Boar Bristles	00	12 ea	1.70/0.08
40792	3" Wide Flat Brush with Boar Bristles	00	12 ea	3.10/0.17
40793	4" Wide Flat Brush with Boar Bristles	00	12 ea	4.65/0.23
<b>Silicone Basting Brushes</b>				
40403 <b>C</b>	2" Silicone Basting Brush	05	12 ea	2.00/0.13
40405 <b>C</b>	3" Silicone Basting Brush	05	12 ea	2.00/0.13
<b>Sparta Food Preparation Brushes</b>				
40412	5.75" Potato Brush with Medium Stiff Polyester Bristles	02	12 ea	3.00/0.17
40164	9.5" Vegetable Brush with Stiff Polyester Bristles	02	12 ea	2.68/0.32
<b>Sparta Utility Brush</b>				
40165	8.75" Utility Brush with Stiff Polyester Bristles	00	12 ea	3.16/0.30
<b>Portioning Cups</b>				
49110-1 <b>Δ</b>	9.5 oz Portion Cup	02	6 ea	1.56/0.17
49112-1 <b>Δ</b>	12 oz Portion Cup	06	6 ea	1.88/0.19
49116-1 <b>Δ</b>	16 oz Portion Cup	01	6 ea	2.27/0.25
49122-1 <b>Δ</b>	20 oz Portion Cup	03	6 ea	2.39/0.28
<b>One Gallon Container &amp; Toggles</b>				
6400 <b>Δ</b>	1 Gallon Container	00	2 ea	3.08/0.54
6401 <b>Δ</b>	Replacement Lid & Assorted Toggles	00	6 ea	0.96/0.05

NSF Listed products are designated with a **Δ**

Cash 'N Carry products are designated with a **C**



# MEASURES & SERVING ACCESSORIES

## Commercial Measures

- Made of durable polycarbonate
- Offer easy measuring of wet ingredients
- Available in Cup, Pint, Quart, Half Gallon and Gallon sizes with U.S. and metric measurements
- Oval shape facilitates pouring from non-spouted side
- Family of measurers nest for storage
- NSF Listed; dishwasher safe



Overhead view of inside measuring lines allow for a faster, more accurate measurement.



## Measuring Cup

- Durable polycarbonate with 1-cup capacity for measuring liquid ingredients
- Withstands temperatures from -40° to 212°F
- Dishwasher safe

## Chef Series™ Measuring Cups & Spoons

- Extra-heavy-duty construction for the most demanding professional use
- Rust-free 18-8 stainless



## Dishers

- Color-coded for easy identification and portion control
- Smooth operating 18-8 stainless steel construction with ribbed plastic handle
- Bowl capacity is stamped on bail
- Number on bail indicates scoops per quart
- NSF Listed; dishwasher safe



### Cash 'N Carry

Selected products also available in a cash 'n carry pack. See page 284.



### Stainless Steel One-Piece Ladles

- Durable one-piece easy cleaning construction
- Hooked handle is reinforced for extra strength
- Dishwasher safe

### Stainless Steel One-Piece Ladles with High-Heat Handles

- Ergonomic design is perfect for self-service soup warmers
- Safety notch prevents ladle from slipping into pots or warmers
- Heat-resistant handle
- Dishwasher safe



Clear(07)

Prod No	Description	Color	Pack	Cs Wt/Cube
<b>Commercial Measures</b>				
43141 $\Delta$	Cup Size PC Measure	07	12 ea	2.82/0.33
43142 $\Delta$	Pint Size PC Measure	07	6 ea	2.30/0.33
43143 $\Delta$	Quart Size PC Measure	07	6 ea	3.15/0.55
43144 $\Delta$	Half Gallon Size PC Measure	07	6 ea	4.25/1.17
43145 $\Delta$	Gallon Size PC Measure	07	6 ea	5.87/2.05
<b>Measuring Cup</b>				
4315	Measuring Cup	07	6 ea	1.50/0.17
<b>Chef Series Measuring Cups &amp; Spoons</b>				
604310	Chef Series Heavy-Weight Measuring Cup Set	—	12 ea	6.80/0.31
604300	Chef Series Heavy-Weight Measuring Spoons Set	—	12 ea	2.20/0.04
<b>Dishers</b>				
60300-6 $\Delta$ <b>C</b>	4.66 oz Disher with White Handle	—	12 ea	6.00/0.52
60300-8 $\Delta$ <b>C</b>	4 oz Disher with Gray Handle	—	12 ea	6.00/0.52
60300-10 $\Delta$ <b>C</b>	3.75 oz Disher with Ivory Handle	—	12 ea	6.00/0.52
60300-12 $\Delta$ <b>C</b>	3.25 oz Disher with Green Handle	—	12 ea	6.00/0.52
60300-16 $\Delta$ <b>C</b>	2.75 oz Disher with Blue Handle	—	12 ea	5.00/0.35
60300-20 $\Delta$ <b>C</b>	2 oz Disher with Yellow Handle	—	12 ea	5.00/0.39
60300-24 $\Delta$ <b>C</b>	1.75 oz Disher with Red Handle	—	12 ea	5.00/0.37
60300-30 $\Delta$ <b>C</b>	1.25 oz Disher with Black handle	—	12 ea	5.00/0.35
60300-40 $\Delta$ <b>C</b>	.88 oz Disher with Orchid handle	—	12 ea	5.00/0.35
<b>Stainless Steel One-Piece Ladles</b>				
607351	1 oz One-Piece Ladle	—	12 ea	2.00/0.07
607352	2 oz One-Piece Ladle	—	12 ea	3.00/0.10
607353	3 oz One-Piece Ladle	—	12 ea	3.00/0.09
607354	4 oz One-Piece Ladle	—	12 ea	3.00/0.16
607356	6 oz One-Piece Ladle	—	12 ea	5.00/0.22
607358	8 oz One-Piece Ladle	—	12 ea	6.00/0.24
607362	12 oz One-Piece Ladle	—	12 ea	7.00/0.29
<b>Stainless Steel One-Piece Ladles with High-Heat Handles</b>				
607374	4 oz One-Piece Ladle with High-Heat Handle	—	12 ea	2.20/0.30
607376	6 oz One-Piece Ladle with High-Heat Handle	—	12 ea	7.00/0.27
607378	8 oz One-Piece Ladle with High-Heat Handle	—	12 ea	7.00/0.27
607382	12 oz One-Piece Ladle with High-Heat Handle	—	12 ea	8.00/0.27

NSF Listed products are designated with a  $\Delta$

Cash 'N Carry products are designated with a **C**





# MEASURE MISERS & BOWLS

## Stainless Steel Measure Misers®

- Portion control spoons in heavy gauge 18-8 stainless steel with durable one-piece construction
- Feature color-coded Kool-Touch handles and built-in pan edge rest
- NSF Listed; dishwasher safe



## Measure Misers®

- Portion control spoon made of break-resistant polycarbonate material
- Each color represents a different size for easy recognition and consistency
- Spoon's flat bottom easily spreads sauces or toppings
- Long handle measure misers have thumb grip for steady control and a notch for resting on pan rim
- Recommended for temperatures up to 212°F; withstands dry heat up to 270°F
- BPA Free
- NSF Listed; dishwasher safe

## Coldmaster® Batter Pan

- Coldmaster system eliminates the inconvenience and mess of ice and reduces the potential of bacterial growth
- 10 qt capacity accommodates standard size fry baskets
- Holds batter at or below the ServSafe®\*\* guidelines of 40°F for up to eight hours\*

\*\*ServSafe® is a registered trademark of the National Restaurant Association

\*Temperature retention is based on Coldmaster being pre-frozen for a minimum of eight hours, then filled directly with pre-chilled foods. Testing was conducted under ambient room temperatures of 76°F.



## Classic Stainless Steel Mixing Bowls

- Flared rim forms an integral pour lip while adding extra strength
- Rust-free 24 gauge, 18-4 stainless steel
- Dishwasher safe



## Melamine Mixing Bowls

- Heavy-duty melamine is safe for temperatures up to 212°F
- Bowls are break and stain-resistant
- Not recommended for microwave use
- Dishwasher safe

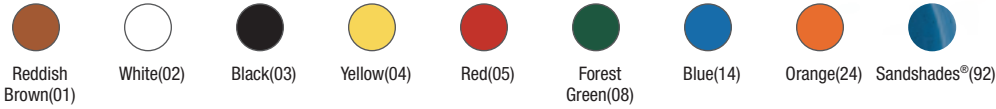

Prod No	Description	Color	Pack	Cs Wt/Cube
<b>Stainless Steel Measure Misers</b>				
604358 Δ	1 oz Solid SS Measure Miser, Yellow	—	12 ea	3.58/0.19
604359 Δ	1 oz Perforated SS Measure Miser, Yellow	—	12 ea	3.58/0.19
604360 Δ	2 oz Solid SS Measure Miser, Red	—	12 ea	3.58/0.19
604361 Δ	2 oz Perforated SS Measure Miser, Red	—	12 ea	3.58/0.18
604370 Δ	3 oz Solid SS Measure Miser, Beige	—	12 ea	3.95/0.18
604371 Δ	3 oz Perforated SS Measure Miser, Beige	—	12 ea	3.58/0.18
604380 Δ	4 oz Solid SS Measure Miser, Green	—	12 ea	4.10/0.24
604381 Δ	4 oz Perforated SS Measure Miser, Green	—	12 ea	4.10/0.18
604390 Δ	6 oz Solid SS Measure Miser, Black	—	12 ea	4.75/0.26
604391 Δ	6 oz Perforated SS Measure Miser, Black	—	12 ea	4.75/0.26
604392 Δ	8 oz Solid SS Measure Miser, Blue	—	12 ea	5.25/0.30
604393 Δ	8 oz Perforated SS Measure Miser, Blue	—	12 ea	5.25/0.26
<b>Measure Misers</b>				
<b>Short Handle</b>				
4921 Δ	1 oz Solid Spoon	04	12 ea	1.30/0.19
4922 Δ	1.5 oz Solid Spoon	01	12 ea	1.25/0.19
4924 Δ	2 oz Solid Spoon	05	12 ea	1.36/0.19
4962 Δ	2 oz Perforated Spoon	05	12 ea	1.36/0.19
4925 Δ	2.5 oz Solid Spoon	24	12 ea	1.43/0.28
4926 Δ	3 oz Solid Spoon	02	12 ea	1.50/0.28
4928 Δ	4 oz Solid Spoon	08	12 ea	1.66/0.28
4929 Δ	4 oz Perforated Spoon	08	12 ea	1.66/0.28
4930 Δ	6 oz Solid Spoon	03	12 ea	1.90/0.28
4931 Δ	8 oz Solid Spoon	14	12 ea	2.30/0.28
<b>Long Handle</b>				
3956 Δ	1 oz Solid Spoon	04	12 ea	1.30/0.19
3957 Δ	1 oz Perforated Spoon	04	12 ea	1.30/0.19
3958 Δ	1.5 oz Solid Spoon	01	12 ea	1.10/0.19
3960 Δ	2 oz Solid Spoon	05	12 ea	1.70/0.19
3961 Δ	2 oz Perforated Spoon	05	12 ea	1.70/0.19
3970 Δ	3 oz Solid Spoon	02	12 ea	1.94/0.28
3971 Δ	3 oz Perforated Spoon	02	12 ea	1.90/0.28
3980 Δ	4 oz Solid Spoon	08	12 ea	2.10/0.28
3981 Δ	4 oz Perforated Spoon	08	12 ea	2.15/0.28
3990 Δ	6 oz Solid Spoon	03	12 ea	2.22/0.28
3991 Δ	6 oz Perforated Spoon	03	12 ea	2.22/0.28
3992 Δ	8 oz Solid Spoon	14	12 ea	2.33/0.28
3993 Δ	8 oz Perforated Spoon	14	12 ea	2.33/0.28
<b>Coldmaster Batter Pan</b>				
CM1072 Δ	Cold Batter Pan	02	1 ea	10.15/0.90
<b>Classic Stainless Steel Mixing Bowls</b>				
601405	5 qt Classic Stainless Steel Mixing Bowl	—	12 ea	9.20/0.48
601408	8 qt Classic Stainless Steel Mixing Bowl	—	12 ea	10.60/0.82
601413	13 qt Classic Stainless Steel Mixing Bowl	—	12 ea	24.00/1.26
601416	16 qt Classic Stainless Steel Mixing Bowl	—	12 ea	13.00/1.34
601420	20 qt Classic Stainless Steel Mixing Bowl	—	6 ea	16.50/1.62
<b>Melamine Mixing Bowls</b>				
43744	1.5 qt, 8" Mixing Bowl	02, 92	12 ea	7.90/0.83
43743	3 qt, 9.75" Mixing Bowl	02, 92	12 ea	12.30/1.45

NSF Listed products are designated with a Δ

# COLANDERS, TONGS & DREDGES

## Colanders

- Seamless satin finish aluminum construction with rolled top edge for extra strength
- Sturdy handles are securely riveted on sides
- Available in extra heavy or standard gauge aluminum



## Spaghetti Strainers

- Heavy gauge aluminum strainer
- Riveted plated steel handle and front hook for resting on stock pot

## Wire Mesh Skimmers

- Heavy-duty construction
- Skimmers lift food from fryer
- Sturdy handles with hanging loops
- Nickel plated construction resists corrosion

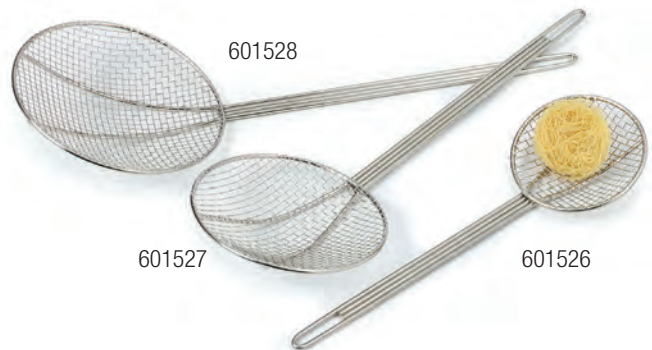

## Tongs

### Heavy-Duty Utility Tongs

- Heavy 20 gauge stainless steel with flat spring for long-lasting service
- Dishwasher safe

## Spectrum® Dura-Kool™ Tongs

- Color-coded Dura-Kool handles provide easy visual for zone isolation
- Single-piece heavy-duty stainless construction eliminates food traps for more sanitary use
- Spring action hinge won't break, also provides convenient hook for storage

Carlisle's Spectrum System supports your HACCP program by promoting zone isolation and reducing the risk of cross-contamination with our complete offering of color-coded kitchen tools and cleaning accessories





### Dredges/Powder Cans

- Heavy-duty seamless dredges in aluminum
- 18-8 mirror polish stainless with wide screw tops for easy filling
- Dishwasher safe

### Shaker/Dredge

- Durable break-resistant polycarbonate shaker can be customized with your logo
- See pages 292-294 for custom imprinting information
- Additional lids can be purchased separately to accommodate different toppings



Prod No	Description	Color	Pack	Cs Wt/Cube
<b>Colanders</b>				
60275	11 qt Heavy-Weight Colander	—	6 ea	30.00/2.37
60277	16 qt Heavy-Weight Colander	—	6 ea	34.00/3.56
60278	8 qt Standard Weight Colander	—	6 ea	14.00/1.82
60279	11 qt Standard Weight Colander	—	6 ea	18.40/2.84
60280	16 qt Standard Weight Colander	—	6 ea	22.20/3.38
<b>Spaghetti Strainer</b>				
60830	10" Spaghetti Strainer	—	12 ea	17.00/1.84
<b>Wire Mesh Skimmers</b>				
601526	6" Bowl Mesh Skimmer	—	12 ea	10.00/0.72
601527	7" Bowl Mesh Skimmer	—	12 ea	11.00/0.72
601528	8" Bowl Mesh Skimmer	—	12 ea	12.00/1.56
601529	9" Bowl Mesh Skimmer	—	12 ea	13.00/2.29
<b>Heavy-Duty Utility Tongs</b>				
607550	9.5" Heavy-Duty Utility Tongs	—	12 ea	5.00/0.11
607552	12" Heavy-Duty Utility Tongs	—	12 ea	6.00/0.13
607556	16" Heavy-Duty Utility Tongs	—	12 ea	7.00/0.17
<b>Spectrum Dura-Kool Tongs</b>				
607560 Δ	9.5" Spectrum Dura-Kool Tong	03, 04, 05, 09, 14	12 ea	3.85/0.14
607562 Δ	12" Spectrum Dura-Kool Tong	03, 04, 05, 09, 14	12 ea	4.85/0.19
607566 Δ	16" Spectrum Dura-Kool Tong	03, 04, 05, 09, 14	12 ea	7.45/0.26
<b>Metal Dredges/Powder Cans</b>				
6030	Alumilite No Handle Dredge	—	12 ea	3.00/0.29
6031	Alumilite Dredge with Handle	—	12 ea	3.00/0.29
607531	Stainless Steel Dredge with Handle	—	12 ea	3.00/0.22
<b>Polycarbonate Shaker/Dredge &amp; Lids</b>				
4250	Dredge with Medium Ground, Rose Lid	55	12 ea	3.10/0.32
4260	Dredge with Cheese, Yellow Lid	04	12 ea	3.10/0.32
4270	Dredge with Salt & Pepper, Beige Lid	06	12 ea	3.10/0.32
4251	Rose Medium Ground Lid	55	12 ea	0.40/0.05
4261	Yellow Cheese Lid	04	12 ea	0.40/0.05
4271	Beige Salt & Pepper Lid	06	12 ea	0.40/0.05

NSF Listed products are designated with a Δ

# SPATULAS, SCRAPERS & SPOONS

## Spatulas & Scrapers

- Completely eliminate unsanitary food traps with the over-molded blade and handle design
- Fine-edge tapered profile of the spatula is perfect for spreading
- Sharp edge and deep bowl of the Scraper reduces waste by helping you scoop out every last drop
- Red handled high-heat versions are rated to 600°F and feature cool-touch handles



### Cash 'N Carry

Selected products also available in a cash 'n carry pack. See page 284.



## High Heat Serving Spoons & Turner

- High heat material withstands temperatures from -40° to 375° F without melting or transferring heat
- Helps prevent scratching on coated surfaces
- Notched handle with hole for hanging
- NSF Listed; dishwasher safe

### High Heat Serving Spoons

- Notched handle allows spoon to rest on edge of food pan

## Stainless Steel Serving Spoons

- Heavy-duty 18 gauge serving spoons are made of 18-8 stainless steel for long-lasting service
- Reinforced handle for extra strength with convenient hole for hanging
- Dishwasher safe

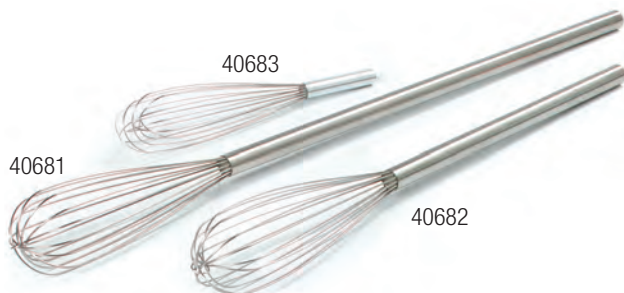

## Sparta® Chef Series™ French Whips

- Sanitary fully-sealed construction eliminates bacteria harboring food traps
- Rust-free 18-8 stainless construction with heavy gauge spring wire loops
- Perfectly weighted and balanced for heavy mixing, stirring, and beating batters, sauces, and other thicker mixtures





### Sparta Spatulas & Paddle Scrapers

- Perfect for general mixing and stirring
- Long handle versions are ideal for vats and large pots
- Stainless steel or nylon/polyethylene scraper available
- Smooth finish, water-proof construction for easy clean-up
- Replacement blades are available for this product



White(02)

Prod No	Description	Color	Pack	Cs Wt/Cube
<b>Spatulas &amp; Scrapers</b>				
44141 <b>C</b>	10" Spatula	02	12 ea	1.50/0.14
44142 <b>C</b>	14" Spatula	02	12 ea	1.50/0.14
44143 <b>C</b>	16" Spatula	02	12 ea	1.50/0.14
44144 <b>C</b>	10" Scraper	02	12 ea	1.50/0.14
44145 <b>C</b>	14" Scraper	02	12 ea	1.50/0.14
44146 <b>C</b>	16" Scraper	02	12 ea	1.50/0.14
44131 <b>C</b>	10.5" High Heat Spatula	02	12 ea	1.50/0.14
44132 <b>C</b>	14" High Heat Spatula	02	12 ea	1.50/0.14
44133 <b>C</b>	16.25" High Heat Spatula	02	12 ea	1.50/0.14
44134 <b>C</b>	10.5" High Heat Scraper	02	12 ea	1.50/0.14
44135 <b>C</b>	14" High Heat Scraper	02	12 ea	1.50/0.14
44136 <b>C</b>	16.25" High Heat Scraper	02	12 ea	1.50/0.14
<b>High Heat Serving Spoons &amp; Turner</b>				
4415 <b>Δ</b>	11" Solid High Heat Serving Spoon	—	12 ea	1.50/0.14
4416 <b>Δ</b>	11" Perforated High Heat Serving Spoon	—	12 ea	1.50/0.14
4425 <b>Δ</b>	13" Solid High Heat Serving Spoon	—	12 ea	1.73/0.16
4426 <b>Δ</b>	13" Perforated High Heat Serving Spoon	—	12 ea	1.70/0.16
4900 <b>Δ</b>	13" Slotted Turner	—	12 ea	2.75/0.17
<b>Stainless Steel Serving Spoons</b>				
607813	13" Solid Spoon	—	12 ea	3.00/0.10
607815	15" Solid Spoon	—	12 ea	3.00/0.13
607813P	13" Perforated Spoon	—	12 ea	3.00/0.10
607815P	15" Perforated Spoon	—	12 ea	3.00/0.13
607813S	13" Slotted Spoon	—	12 ea	3.00/0.10
607815S	15" Slotted Spoon	—	12 ea	3.00/0.13
<b>Sparta Chef Series French Whips</b>				
40683	18" Chef Series Heavy-Weight French Whip	—	2 ea	1.50/0.28
40681	36" Chef Series Heavy-Weight French Whip	—	2 ea	4.20/0.46
40682	48" Chef Series Heavy-Weight French Whip	—	2 ea	5.14/0.60
<b>Sparta Spatulas &amp; Paddle Scrapers</b>				
40347 <b>Δ</b>	36" Stainless Steel Paddle Scraper	—	6 ea	13.75/0.55
40349 <b>Δ</b>	48" Stainless Steel Paddle Scraper	—	6 ea	14.00/0.63
40359 <b>Δ</b>	60" Stainless Steel Paddle Scraper	—	6 ea	18.60/0.88
40350	13.5" Nylon Handle with 4.5" x 7.5" Nylon Spatula Scraper	02	6 ea	2.75/0.23
40351	13.5" Nylon Handle with 4.5" x 7.5" Polyethylene Soft Spatula Scraper	02	6 ea	2.65/0.23
40352	40" Nylon Handle with 4.5" x 7.5" Nylon Paddle Scraper	02	6 ea	7.00/0.55
40353	48" Nylon Handle with 4.5" x 7.5" Nylon Paddle Scraper	02	6 ea	11.00/0.76
40354	48" Stainless Steel Handle with 4.5" x 7.5" Nylon Paddle Scraper	—	6 ea	15.30/0.76
40355	72" Stainless Steel Handle with 4.5" x 7.5" Nylon Paddle Scraper	—	6 ea	45.00/0.28
40356	48" Stainless Steel Handle with 6.5" x 9" Nylon Paddle Scraper	—	3 ea	8.60/0.76
40361	4.5" x 7" Standard Nylon Replacement Blade	02	6 ea	1.50/0.10

NSF Listed products are designated with a **Δ**

Cash 'N Carry products are designated with a **C**



# KITCHEN TOOLS



607400

## Meat Tenderizer

- Heavy duty solid cast aluminum with prong side for tenderizing and smooth side for thinning meats



607410

## Steak Weight

- Heavy iron weight transfers heat to speed cooking and brown evenly



60300

## Timer

- Long ringing timer
- Made of sturdy plastic



### Cash 'N Carry

Selected products also available in a cash 'n carry pack. See page 284.



6020

## Stainless Steel Peeler

- Peeler has swivel action stainless steel blade
- Tip can be used for coring and scraping



41076-1

41077-1

## Sparta® Foodservice Shovels

- Heavy duty one-piece plastic construction
- Supports heavy loads, safe to use with food, will not rust, and cleans up easily



White(02)



40690

40691

## Wrap-Around Vinyl Aprons

- 40690 has sturdy, reinforced ties
- 40691 for heavy duty protection from oils and grease

**WARNING:** Products identified on this page with the following symbol ▼ contain chemicals, including one or more phthalates, known to the State of California to cause cancer and birth defects and other reproductive harm.

Prod No	Description	Color	Pack	Cs Wt/Cube
<b>Meat Tenderizer</b>				
607400	14" Solid Cast Aluminum Meat Tenderizer	—	12 ea	13.23/0.69
<b>Steak Weight</b>				
607410	Cast Iron Steak Weight	—	12 ea	24.00/1.04
<b>Timer</b>				
60300	One Hour Timer	—	12 ea	6.00/0.88
<b>Stainless Steel Peeler</b>				
6020	Peeler with Stainless Steel Blade	—	6 ea	1.00/1.56
<b>Sparta Foodservice Shovels</b>				
41076-1	11" Wide Foodservice Shovel	02	1 ea	4.20/3.16
41077-1	14" Wide Foodservice Shovel	02	1 ea	5.80/2.74
<b>Vinyl Aprons</b>				
40690 ▼	Wrap Around Vinyl Apron	—	6 pk	34.75/1.30
40691 ▼	Wrap Around White Nitrile Heavy Duty Apron	—	12 ea	14.00/0.73

Cash 'N Carry products are designated with a C



# STORAGE & HANDLING

A leader in the industry, Carlisle ensures that all of our products are designed for safely storing and transporting food. Distinct color-coding, superior sealing and easy to clean surfaces are just some of the ways that Carlisle simplifies maintaining your food safety program.

<b>Product</b>	<b>Page</b>
Adapter Bars .....	176
Adapter Plates .....	176
Bains Maries	
Plastic .....	186
Stainless Steel .....	176
Bins, Ingredient .....	188
Containers	
Bains Maries .....	176 & 186
Food Boxes .....	182 & 183
Food Pans .....	174 & 175, 178-181
Rounds .....	186
Squares .....	184 & 185
Drain Grates .....	176
Economical Space Savers .....	185

<b>Product</b>	<b>Page</b>
Floor Rack System .....	188
Food Boxes, Containers	
StorPlus Food Storage Boxes & Lids .....	182 & 183
StorPlus Round Containers .....	186
StorPlus Square Food Storage Containers .....	184
Food Pans	
DuraPan Food Pan Accessories .....	174
DuraPan Food Pans .....	174-176
High Heat Pan .....	181
Polycarbonate Pans .....	180
Smart Lids .....	179
Top Notch Food Pans .....	174-178
Universal Food Pan Lids .....	178
Insets .....	177

## FOOD PANS & LIDS

Food pans are the back bone of any foodservice operation. For storing, preparing, and serving, they are a necessity. Only Carlisle offers you complete versatility with a broad range of food pans to meet your needs.

- Innovative solutions like our patented Top Notch® Food Pans in polycarbonate or high heat
- Durable solutions like our rugged DuraPan™ Food Pans in satin finish stainless steel

### DuraPan Covers

- Made of heavy gauge 18-8 stainless steel
- Available in solid or slotted styles
- Recessed handles offer a secure grip
- Notched lids allow easy access for serving spoons
- Hinged covers (607000H & 607802H) help maintain temperatures while allowing access to food



**DuraPans Covers, Recessed Handles**  
Large, recessed handles offer a secure grip. Notched lids allow easy access with serving spoons

### Full Shoulders

Prevent jamming during storage and provide added strength for longer life



### Double Reinforced Corners

With unique impact resistant edge design holds shape even under the toughest conditions

### Spoonable Bottoms

Add structural rigidity; allows easy access to food and makes clean up easier



### Steam Table Application

DuraPans impact resistant edge maintains shape better and lays flat, providing a tight seal for better temperature retention in steam tables

### Coldmaster® Application

Use DuraPans with Coldmaster Coldpans (shown on page 93) to keep foods cold without ice or electricity





Available in heavy gauge or light gauge, Carlisle offers a wide range of accessories including solid and slotted covers, drain shelves, divided pans, and adapter bars listed throughout this section.

Prod No	Description	Pack	Cs Wt/Cube
<b>Heavy Gauge</b>			
<b>Full-Size – 20.75" x 12.75"</b>			
608002 $\Delta$	Pan – 2.5" (10.4 qt)	6 ea	20.00/1.09
608004 $\Delta$	Pan – 4" (16.6 qt)	6 ea	26.00/1.76
608006 $\Delta$	Pan – 6" (24.9 qt)	6 ea	26.00/1.56
<b>Two-Thirds Size – 13.88" x 12.75"</b>			
608236 $\Delta$	Pan – 6" (16.2 qt)	6 ea	17.20/1.48
<b>One-Half Size – 12.75" x 10.38"</b>			
608122 $\Delta$	Pan – 2.5" (0.9 qt)	6 ea	10.50/0.48
608124 $\Delta$	Pan – 4" (1.4 qt)	6 ea	13.00/0.81
608126 $\Delta$	Pan – 6" (2.1 qt)	6 ea	16.00/1.03
<b>One-Third Size – 12.75" x 6.88"</b>			
608132 $\Delta$	Pan – 2.5" (3.4 qt)	6 ea	7.75/0.44
608134 $\Delta$	Pan – 4" (5.4 qt)	6 ea	18.00/1.01
608136 $\Delta$	Pan – 6" (8.1 qt)	6 ea	22.00/1.16
<b>One-Quarter Size – 10.38" x 6.38"</b>			
608142 $\Delta$	Pan – 2.5" (2.6 qt)	6 ea	12.00/0.42
608144 $\Delta$	Pan – 4" (4.2 qt)	6 ea	16.00/0.70
608146 $\Delta$	Pan – 6" (6.2 qt)	6 ea	20.00/0.86
<b>One-Sixth Size – 6.88" x 6.25"</b>			
608162 $\Delta$	Pan – 2.5" (1.6 qt)	6 ea	10.00/0.33
608164 $\Delta$	Pan – 4" (2.6 qt)	6 ea	11.00/0.40
608166 $\Delta$	Pan – 6" (3.9 qt)	6 ea	12.00/0.55
<b>One-Ninth Size – 6.88" x 4.25"</b>			
608192 $\Delta$	Pan – 2.5" (1.0 qt)	6 ea	2.83/0.22
608194 $\Delta$	Pan – 4" (1.7 qt)	6 ea	3.33/0.28
<b>Light Gauge</b>			
<b>Full-Size – 20.75" x 12.75"</b>			
607001 $\Delta$	Pan – 1" (4.2 qt)	6 ea	15.00/0.89
607002 $\Delta$	Pan – 2.5" (10.4 qt)	6 ea	15.00/1.03
607004 $\Delta$	Pan – 4" (16.6 qt)	6 ea	20.00/1.39
607006 $\Delta$	Pan – 6" (24.9 qt)	6 ea	19.40/2.12
607002P $\Delta$	Perforated Pan – 2.5"	6 ea	15.00/0.98
607004P $\Delta$	Perforated Pan – 4"	6 ea	20.00/1.39
607006P $\Delta$	Perforated Pan – 6"	6 ea	23.00/1.56
607000C $\Delta$	Solid Cover	6 ea	11.60/0.86
607000CS	Slotted Cover	6 ea	13.70/0.90
607000H	Hinged Flat Cover with Handles	6 ea	21.00/1.38
607802H	Hinged Dome Cover with Handles	3 ea	10.60/1.89

NSF Listed products are designated with a  $\Delta$

Prod No	Description	Pack	Cs Wt/Cube
<b>Two-Thirds Size – 13.88" x 12.75"</b>			
607232 $\Delta$	Pan – 2.5" (6.8 qt)	6 ea	25.00/1.08
607236 $\Delta$	Pan – 6" (16.2 qt)	6 ea	17.00/1.55
607230C $\Delta$	Solid Cover	6 ea	17.00/1.02
<b>One-Half Size – 12.75" x 10.38"</b>			
607122 $\Delta$	Pan – 2.5" (0.9 qt)	6 ea	8.40/0.46
607124 $\Delta$	Pan – 4" (1.4 qt)	6 ea	10.00/0.81
607126 $\Delta$	Pan – 6" (2.1 qt)	6 ea	11.80/1.05
607122P $\Delta$	Perforated Pan – 2.5"	6 ea	8.25/0.49
607124P $\Delta$	Perforated Pan – 4"	6 ea	10.00/0.81
607120C $\Delta$	Solid Cover	6 ea	7.50/0.44
607120CS	Slotted Cover	6 ea	6.20/0.41
<b>One-Half Long Size – 20.5" x 6.38"</b>			
60700HL2 $\Delta$	Pan – 2.5" (5.2 qt)	6 ea	21.80/0.90
60700HL4 $\Delta$	Pan – 4" (8.3 qt)	6 ea	12.80/0.95
60700HL6 $\Delta$	Pan – 6" (12.5 qt)	6 ea	13.80/1.14
60700HLC $\Delta$	Solid Cover	6 ea	21.80/0.74
<b>One-Third Size – 12.75" x 6.88"</b>			
607132 $\Delta$	Pan – 2.5" (3.4 qt)	6 ea	5.50/0.30
607134 $\Delta$	Pan – 4" (5.4 qt)	6 ea	7.00/0.53
607136 $\Delta$	Pan – 6" (8.1 qt)	6 ea	20.00/0.98
607130C $\Delta$	Solid Cover	6 ea	4.20/0.28
607130CS	Slotted Cover	6 ea	4.00/0.21
<b>One-Quarter Size – 10.38" x 6.38"</b>			
607142 $\Delta$	Pan – 2.5" (2.6 qt)	6 ea	9.00/0.51
607144 $\Delta$	Pan – 4" (4.2 qt)	6 ea	12.00/0.79
607146 $\Delta$	Pan – 6" (6.2 qt)	6 ea	16.60/0.95
607140C $\Delta$	Solid Cover	6 ea	4.25/0.20
607140CS	Slotted Cover	6 ea	8.00/0.39
<b>One-Sixth Size – 6.88" x 6.25"</b>			
607162 $\Delta$	Pan – 2.5" (1.6 qt)	6 ea	8.00/0.33
607164 $\Delta$	Pan – 4" (2.6 qt)	6 ea	10.00/0.40
607166 $\Delta$	Pan – 6" (3.9 qt)	6 ea	14.00/0.52
607160C $\Delta$	Solid Cover	6 ea	5.20/0.30
607160CS	Slotted Cover	6 ea	5.00/0.30
<b>One-Ninth Size – 6.88" x 4.25"</b>			
607192 $\Delta$	Pan – 2.5" (1.0 qt)	6 ea	13.00/0.22
607194 $\Delta$	Pan – 4" (1.7 qt)	6 ea	18.00/0.28
607190C $\Delta$	Solid Cover	6 ea	5.00/0.20
607190CS	Slotted Cover	6 ea	5.00/0.20

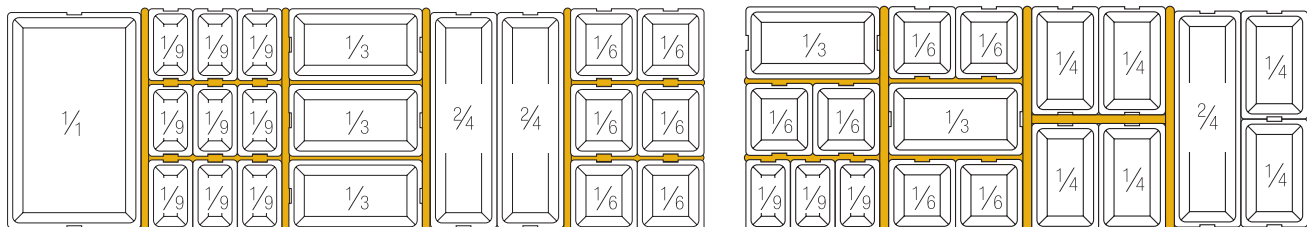

## FOOD PANS &amp; ACCESSORIES



Divided Pan with PC140N  
Cateraide™ Top Loader

### Drain Grates

- Chrome plated, heavy-duty grates with durable welded construction holds food above pan
- Use for cooling or draining foods
- Fits full size pans



### Adapter Bars

- Use adapter bars with DuraPans in steam table applications, Cateraides, or other standard transport containers
- Two sizes available to work with full or fractional size pans

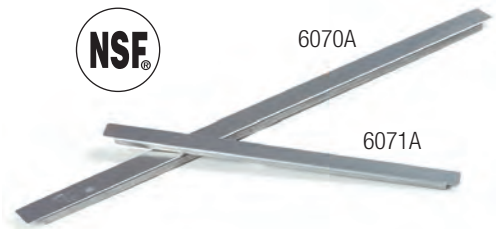

607712

### Stainless Steel Bains Maries

- Heavy gauge 18-8 stainless steel ideal for serving, storing, and preparing foods, sauces, and dressings
- Easy to clean, satin finish and smooth rounded edges
- Optional covers have recessed handles to allow stacking of covered containers

### Adapter Plates

- 18-8 stainless steel adapters fit standard steam table openings to hold insets and bains maries in prep and serving areas



## Insets

- Use in round steam tables or soup warmers and stations
- Offer heavy gauge, 18-8 stainless steel satin finish and smooth rounded edges
- Optional covers help maintain temperatures, sold separately
- Hinged covers clip to inset, allowing one-hand access
- Bakelite knob on hinged cover stays cool to the touch



Prod No	Description	Color	Pack	Cs Wt/Cube
<b>Divided DuraPans</b>				
607002D $\Delta$	Full-Size Divided Pan 2.5' Deep	—	6 ea	15.00/0.98
<b>Drain Grates</b>				
602202	Drain Grate - Fits Full-Size Food Pan	—	6 ea	7.00/1.29
602203	Drain Grate - Fits Half-Size Food Pan	—	6 ea	5.00/0.19
<b>Adapter Bars</b>				
6070A $\Delta$	20.5" Adapter Bar	—	12 ea	6.00/0.24
6071A $\Delta$	12.75" Adapter Bar	—	12 ea	3.00/0.09
<b>Adapter Plates</b>				
607712	Adapter Plate with Two 6.5" Inset Holes	—	12 ea	29.00/0.40
607714	Adapter Plate with One 6.5" and One 8.5" Inset Holes	—	12 ea	25.00/0.40
<b>Bains Maries</b>				
607901	1.25 qt Bains Marie	—	6 ea	7.00/0.27
607902	2 qt Bains Marie	—	6 ea	8.00/0.44
607904	4.25 qt Bains Marie	—	6 ea	7.80/0.81
607908	8.25 qt Bains Marie	—	6 ea	13.60/1.37
607912	12 qt Bains Marie	—	6 ea	19.00/2.19
607902C	2 qt Cover	—	6 ea	2.00/0.12
607904C	4.25 qt Cover	—	6 ea	2.20/0.17
607908C	8.25 qt Cover	—	6 ea	4.00/0.26
607912C	12 qt Cover	—	6 ea	6.00/0.30
<b>Insets</b>				
607704	4 qt Inset - Fits 6.5" Opening	—	6 ea	8.00/0.63
607707	7 qt Inset - Fits 8.5" Opening	—	6 ea	11.00/0.99
607711	11 qt Inset - Fits 10.5" Opening	—	6 ea	10.00/1.14
607704CS	4 qt Slotted Cover	—	6 ea	2.60/0.20
607707CS	7 qt Slotted Cover	—	6 ea	4.00/0.33
607711CS	11 qt Slotted Cover	—	6 ea	7.00/0.35
607707H	7 qt Hinged Cover	—	6 ea	6.40/0.59
607711H	11 qt Hinged Cover	—	6 ea	9.00/0.78

NSF Listed products are designated with a  $\Delta$

## FOOD PANS &amp; LIDS

**Top Notch® Food Pans**

- Easy-lift spoon notches are located at each end of the food pan for easy removal from steam tables and recessed counters
- Just place the end of a spoon or other utensil under the reinforced notch, lift, and remove food pan
- Polycarbonate pans withstand tough use; resist food acids and oils; and can withstand temperatures of -40°F to 212°F
- High-heat pans excel in high temperature applications (-40°F to 375°F)
- Easy-lift notch reduces direct hand-to-food contact for greater food safety
- Top Notch Food Pans meet specifications for use in food bars and steam tables
- Pans meet EN 631-1 Euro Norm standards\*\* for inter-stacking with existing pans
- NSF Listed; dishwasher safe

\* U.S. Patent No. 5676276

\*\* Excluding .17 and .11 sizes

**Universal Food Pan Lids**

- Universal Lids fit Carlisle Top Notch Food Pans as well as other major brands on the market
- Available in standard sizes
- Fits both gastronorm and standard size food pans
- Carlisle lids stack with themselves for easy storage
- Available in polycarbonate or high heat material
- NSF Listed; dishwasher safe

**Catering Application**

Top Notch Food Pans fit Carlisle Cateraides™ (see pages 134-136) and other standard transport containers for offsite catering, company lunches, etc.

**Back-of-the-House Application**

Top Notch Food Pans are great for back-of-the-house; at easy-to-reach prep stations or for refrigerated food storage. Drain shelves help keep food fresh.

**High Heat Applications**

Top Notch High Heat Food Pans provide the single container solution for cold storage, flash-freezing, microwave preheat/cooking, and prolonged high temperature retention in steam table applications.



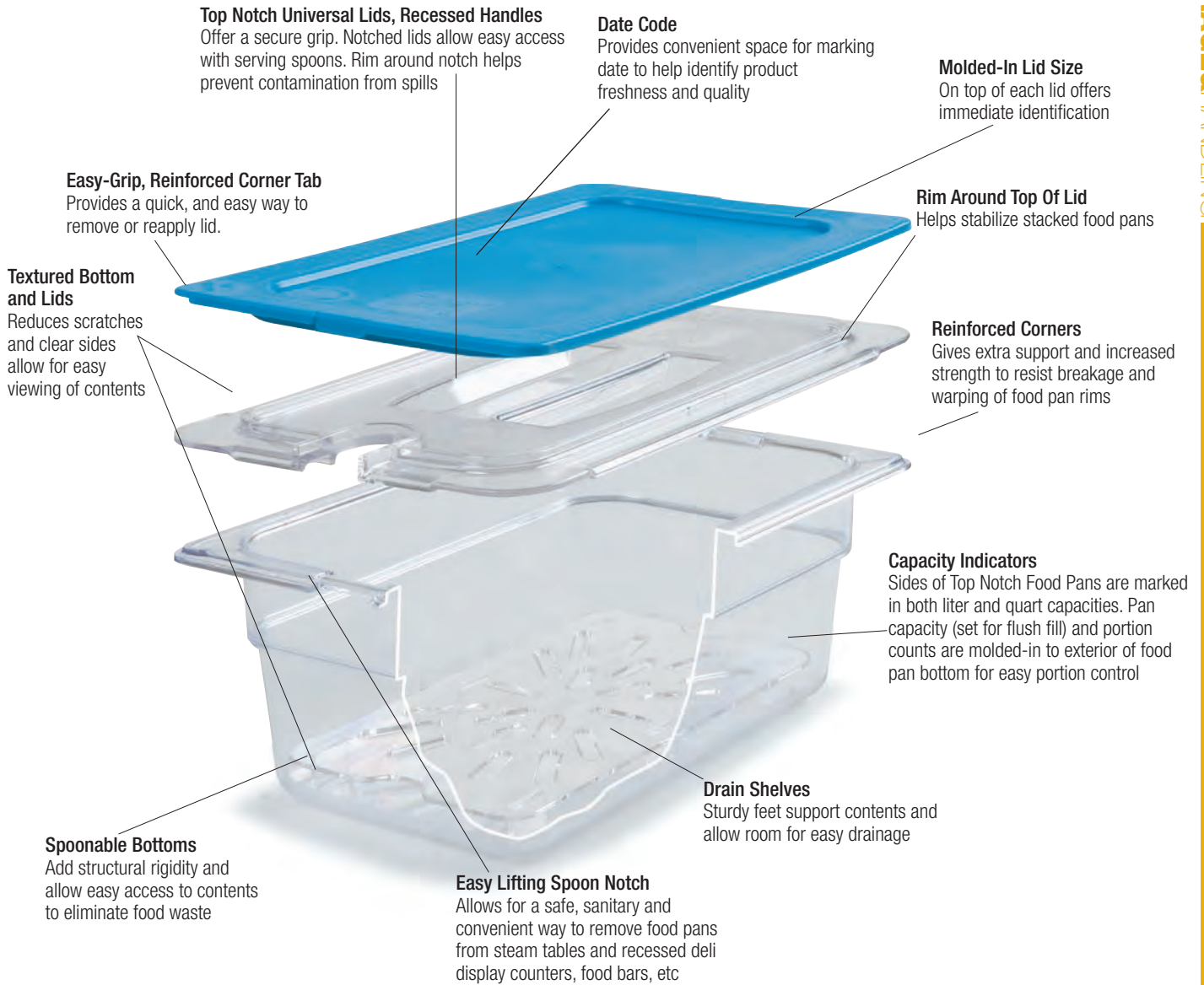

Use Top Notch Food Pans with Maximizer™, Six★Star™, and Five★Star™ Food Bars shown on pages 100 & 101 and with CATERAIDES shown on pages 134-136

### Smart Lids™

- Unique inside seal design provides superior leak-resistance and keeps your foods fresher, longer
- Perfect for transporting foods to offsite locations
- Smart Lids (combined with Top Notch Food Pans) fit inside CATERAIDE Top Loaders and End Loaders (shown on pages 134-136)
- Polyethylene material is dishwasher safe; for use in -40°F to 180°F

Color: Blue(14)

Smart Lid's unique inside seal design provides superior leak-resistance; protects against spills



# FOOD PANS & LIDS

## Polycarbonate Food Pans & Lids

- Polycarbonate pans and lids withstand tough use
- Resist food acids and oils; and can withstand temperatures of -40°F to 212°F
- For a leak-resistant seal use Smart Lids™ listed on page 179

Colors: Pans available in Clear(07), Black(03);  
PC Universal Lids and Drains in Clear(07)



Black(03)



Clear(07)



Blue(14)

Prod No	Description	Pack	Cs Wt/Cube
<b>Full-Size – 20.75" x 12.75"</b>			
10200 $\Delta$	Pan – 2.5" (7.6 qt)	6 ea	10.70/1.16
10201 $\Delta$	Pan – 4" (12.7 qt)	6 ea	14.30/1.84
10202 $\Delta$	Pan – 6" (19.4 qt)	6 ea	17.60/2.41
10203 $\Delta$	Pan – 8" (25.9 qt)	6 ea	19.50/3.42
10215 $\Delta$	Drain Shelf	6 ea	6.15/0.34
<b>One-Half Size – 12.75" x 10.38"</b>			
10220 $\Delta$ $\text{C}$	Pan – 2.5" (3.6 qt)	6 ea	5.65/0.56
10221 $\Delta$ $\text{C}$	Pan – 4" (5.6 qt)	6 ea	7.60/0.89
10222 $\Delta$ $\text{C}$	Pan – 6" (8.7 qt)	6 ea	9.50/1.27
10223* $\Delta$	Pan – 8" (11.4 qt)	6 ea	11.45/1.50
10235 $\Delta$	Drain Shelf	6 ea	2.60/0.23
<b>One-Half Long Size – 20.75" x 6.25"</b>			
10240 $\Delta$	Pan – 2.5" (2.9 qt)	6 ea	6.25/0.60
10241 $\Delta$	Pan – 4" (5.1 qt)	6 ea	7.95/0.94
<b>One-Third Size – 12.75" x 7"</b>			
10260 $\Delta$ $\text{C}$	Pan – 2.5" (2.4 qt)	6 ea	4.45/0.46
10261 $\Delta$ $\text{C}$	Pan – 4" (3.8 qt)	6 ea	5.95/0.73
10262 $\Delta$ $\text{C}$	Pan – 6" (5.7 qt)	6 ea	7.15/0.88
10269 $\Delta$	Pan – 8" (7.3 qt)	6 ea	4.35/0.88
10275 $\Delta$	Drain Shelf	6 ea	1.40/0.12
<b>One-Quarter Size – 10.25" x 6.38"</b>			
10280 $\Delta$ $\text{C}$	Pan – 2.5" (1.7 qt)	6 ea	3.65/0.36
10281 $\Delta$ $\text{C}$	Pan – 4" (2.8 qt)	6 ea	4.65/0.55
10282 $\Delta$ $\text{C}$	Pan – 6" (4.0 qt)	6 ea	6.10/0.69
10295 $\Delta$	Drain Shelf	6 ea	1.00/0.08
<b>One-Sixth Size – 6.75" x 6.38"</b>			
10300 $\Delta$ $\text{C}$	Pan – 2.5" (1.1 qt)	6 ea	2.35/0.26
10301 $\Delta$ $\text{C}$	Pan – 4" (1.7 qt)	6 ea	3.10/0.35
10302 $\Delta$ $\text{C}$	Pan – 6" (2.5 qt)	6 ea	3.80/0.45
10315 $\Delta$	Drain Shelf	6 ea	1.00/0.42
<b>One-Ninth Size – 6.75" x 4.25"</b>			
10320 $\Delta$ $\text{C}$	Pan – 2.5" (0.7 qt)	6 ea	1.85/0.18
10321 $\Delta$ $\text{C}$	Pan – 4" (1.0 qt)	6 ea	2.30/0.22
10355 $\Delta$	Drain Grate	6 ea	0.80/0.42

NSF Listed products are designated with a  $\Delta$

Cash 'N Carry products are designated with a  $\text{C}$

\* Not available in Black

Prod No	Description	Pack	Cs Wt/Cube
<b>Lids for Full-Size Pans</b>			
10210U $\Delta$	Handled Lid	6 ea	9.65/0.94
10211U $\Delta$	Handled Notched Lid	6 ea	9.65/0.89
10216U $\Delta$	Flat Lid	6 ea	9.10/0.59
10217U $\Delta$	Flat Lid Notched	6 ea	9.10/0.59
<b>Lids for One-Half Size Pans</b>			
10230U $\Delta$	Handled Lid	6 ea	4.20/0.42
10231U $\Delta$	Handled Notched Lid	6 ea	4.15/0.42
10236U $\Delta$	Flat Lid	6 ea	4.40/0.30
10237U $\Delta$	Flat Lid Notched	6 ea	4.40/0.30
<b>Lids for One-Half Long Size Pans</b>			
10250U $\Delta$	Handled Lid	6 ea	4.50/0.56
10256U $\Delta$	Flat Lid	6 ea	4.71/0.56
10257U $\Delta$	Flat Lid Notched	6 ea	4.69/0.56
<b>Lids for One-Third Size Pans</b>			
10270U $\Delta$	Handled Lid	6 ea	3.60/0.35
10271U $\Delta$	Handled Notched Lid	6 ea	3.55/0.33
10276U $\Delta$	Flat Lid	6 ea	3.00/0.21
10277U $\Delta$	Flat Lid Notched	6 ea	3.00/0.21
<b>Lids for One-Quarter Size Pans</b>			
10290U $\Delta$	Handled Lid	6 ea	2.45/0.25
10291U $\Delta$	Handled Notched Lid	6 ea	2.35/0.25
10296U $\Delta$	Flat Lid	6 ea	2.20/0.16
<b>Lids for One-Sixth Size Pans</b>			
10310U $\Delta$	Handled Lid	6 ea	1.70/0.16
10311U $\Delta$	Handled Notched Lid	6 ea	1.80/0.17
10316U $\Delta$	Flat Lid	6 ea	1.60/0.10
10317U $\Delta$	Flat Lid Notched	6 ea	1.60/0.10
<b>Lids for One-Ninth Size Pans</b>			
10336U $\Delta$	Flat Lid	6 ea	1.05/0.07
10337U $\Delta$	Flat Lid Notched	6 ea	1.05/0.07



### Cash 'N Carry

Selected products also available in a cash 'n carry pack. See page 284.

## High Heat Food Pans & Lids

- High heat pans excel in high temperature applications (-40°F to 375°F)
- For a leak-resistant seal use Smart Lids

Colors: Pans available in Amber(13), Black(03), 10520, High Heat Universal Lids, and Drains in Amber(13) only



Black(03)



Amber(13)



Blue(14)

Prod No	Description	Pack	Cs Wt/Cube
<b>Full-Size – 20.75" x 12.75"</b>			
10400 $\Delta$	Pan – 2.5" (7.6 qt)	6 ea	11.05/1.16
10401 $\Delta$	Pan – 4" (12.7 qt)	6 ea	15.00/1.84
10402 $\Delta$	Pan – 6" (19.4 qt)	6 ea	18.30/2.41
10415 $\Delta$	Drain Shelf	6 ea	6.36/0.34
<b>One-Half Size – 12.75" x 10.38"</b>			
10420 $\Delta$ $\text{\textcircled{C}}$	Pan – 2.5" (3.6 qt)	6 ea	5.90/0.57
10421 $\Delta$ $\text{\textcircled{C}}$	Pan – 4" (5.6 qt)	6 ea	8.00/0.89
10422 $\Delta$ $\text{\textcircled{C}}$	Pan – 6" (8.7 qt)	6 ea	9.95/1.27
10423 $\Delta$	Pan – 8" (11.4 qt)	6 ea	13.25/1.50
10435 $\Delta$	Drain Shelf	6 ea	2.75/0.23
<b>One-Half Long Size – 20.75" x 6.25"</b>			
10440 $\Delta$	Pan – 2.5" (2.9 qt)	6 ea	6.90/0.60
10441 $\Delta$	Pan – 4" (5.1 qt)	6 ea	7.15/0.94
<b>One-Third Size – 12.75" x 7"</b>			
10460 $\Delta$ $\text{\textcircled{C}}$	Pan – 2.5" (2.4 qt)	6 ea	4.65/0.46
10461 $\Delta$ $\text{\textcircled{C}}$	Pan – 4" (3.8 qt)	6 ea	5.95/0.73
10462 $\Delta$ $\text{\textcircled{C}}$	Pan – 6" (5.7 qt)	6 ea	7.50/0.89
10469 $\Delta$	Pan – 8" (7.3 qt)	6 ea	4.35/0.88
10475 $\Delta$	Drain Shelf	6 ea	1.44/0.12
<b>One-Quarter Size – 10.25" x 6.38"</b>			
10480 $\Delta$ $\text{\textcircled{C}}$	Pan – 2.5" (1.7 qt)	6 ea	3.80/0.36
10481 $\Delta$ $\text{\textcircled{C}}$	Pan – 4" (2.8 qt)	6 ea	4.75/0.55
10482 $\Delta$ $\text{\textcircled{C}}$	Pan – 6" (4.0 qt)	6 ea	6.10/0.69
10495 $\Delta$	Drain Shelf	6 ea	1.05/0.08
<b>One-Sixth Size – 6.75" x 6.38"</b>			
10500 $\Delta$ $\text{\textcircled{C}}$	Pan – 2.5" (1.1 qt)	6 ea	2.31/0.26
10501 $\Delta$ $\text{\textcircled{C}}$	Pan – 4" (1.7 qt)	6 ea	3.25/0.40
10502 $\Delta$ $\text{\textcircled{C}}$	Pan – 6" (2.5 qt)	6 ea	4.05/0.45
10515 $\Delta$	Drain Shelf	6 ea	1.00/0.11
<b>One-Ninth Size – 6.75" x 4.25"</b>			
10520 $\Delta$ $\text{\textcircled{C}}$	Pan – 2.5" (0.7 qt)	6 ea	1.95/0.20
10521 $\Delta$ $\text{\textcircled{C}}$	Pan – 4" (1.0 qt)	6 ea	2.45/0.26
10535 $\Delta$	Drain Grate	6 ea	0.80/0.42

NSF Listed products are designated with a  $\Delta$

Cash 'N Carry products are designated with a  $\text{\textcircled{C}}$



### Cash 'N Carry

Selected products also available in a cash 'n carry pack. See page 284.

Prod No	Description	Pack	Cs Wt/Cube
<b>Lids for Full Size Pans</b>			
10410U $\Delta$	Handled Lid	6 ea	10.92/0.94
10411U $\Delta$	Handled Notched Lid	6 ea	10.57/0.89
10416U $\Delta$	Flat Lid	6 ea	10.60/0.59
10417U $\Delta$	Flat Lid Notched	6 ea	10.60/0.59
<b>Lids for One-Half Size Pans</b>			
10430U $\Delta$	Handled Lid	6 ea	5.60/0.42
10431U $\Delta$	Handled Notched Lid	6 ea	4.80/0.42
10436U $\Delta$	Flat Lid	6 ea	5.10/0.30
10437U $\Delta$	Flat Lid Notched	6 ea	5.10/0.30
<b>Lids for One-Half Long Size Pans</b>			
10450U $\Delta$	Handled Lid	6 ea	4.95/0.56
10456U $\Delta$	Flat Lid	6 ea	5.44/0.56
10457U $\Delta$	Flat Lid Notched	6 ea	5.41/0.56
<b>Lids for One-Third Size Pans</b>			
10470U $\Delta$	Handled Lid	6 ea	3.42/0.39
10471U $\Delta$	Handled Notched Lid	6 ea	4.10/0.33
10476U $\Delta$	Flat Lid	6 ea	3.50/0.21
10477U $\Delta$	Flat Lid Notched	6 ea	3.50/0.21
<b>Lids for One-Quarter Size Pans</b>			
10490U $\Delta$	Handled Lid	6 ea	2.65/0.25
10491U $\Delta$	Handled Notched Lid	6 ea	2.65/0.25
10496U $\Delta$	Flat Lid	6 ea	2.60/0.16
10497U $\Delta$	Flat Lid Notched	6 ea	2.60/0.16
<b>Lids for One-Sixth Size Pans</b>			
10510U $\Delta$	Handled Lid	6 ea	2.10/0.16
10511U $\Delta$	Handled Notched Lid	6 ea	2.33/0.17
10516U $\Delta$	Flat Lid	6 ea	1.80/0.10
10517U $\Delta$	Flat Lid Notched	6 ea	1.80/0.10
<b>Lids One-Ninth Size Pan</b>			
10536U $\Delta$	Flat Lid	6 ea	0.97/0.07
10537U $\Delta$	Flat Lid Notched	6 ea	0.97/0.07
<b>Smart Lids</b>			
10212	Full Size Smart Lid	6 ea	7.00/0.59
10232	One-Half Size Smart Lid	6 ea	3.50/0.30
10272	One-Third Size Smart Lid	6 ea	2.50/0.21
10292	One-Quarter Size Smart Lid	6 ea	1.95/0.16
10312	One-Sixth Size Smart Lid	6 ea	1.40/0.10
10332	One-Ninth Size Smart Lid	6 ea	0.95/0.07

## FOOD STORAGE CONTAINERS



### StorPlus™ Food Storage Boxes & Lids

- Carlisle's exclusive color-coded boxes are one of the products designed to help control the potential for cross-contamination during the storage and transfer of ready-to-eat and raw foods

#### StorPlus Food Storage Boxes

- Reinforced top and bottom corners on both box and lid, help prevent chipping and cracking
- Quart, gallon, and liter capacity indicators (on 12" x 18" box) offer portion control for both domestic and international use
- All sizes stack for easy, efficient storage and fit standard carts and racks
- StorPlus boxes stack with other boxes on the market
- Smooth interior surface makes cleaning easy
- Boxes can be used for organizing and sorting kitchen supplies
- Boxes double as dough proofing bus boxes, warewashing tubs for kitchen overflow, or remote locations
- "Lock-Tight" lids can be reversed and used as bun pan or tray
- 18" x 26" colander is ideal for storing, draining, thawing, and marinating foods; keeps lettuce crisp, thaws and drains fish on ice, marinates chicken, etc.
- 10628 fits 18" x 26" x 6" or deeper boxes
- Polycarbonate boxes provide easy visibility, superior resistance to food acids and oils and withstands temperatures from -40°F to 212°F
- Polyethylene boxes offers economical storage and transport and withstands temperatures from -40°F to 180°F
- NSF Listed; dishwasher safe

#### Benefits of StorPlus Color-Coded Storage Boxes:

- Prevents cross-contamination
- RimGlow™ technology gives the boxes and lids a distinct, yet transparent color to segregate them by usage
- Can be used with Carlisle Spectrum® identification system for easy integration into existing programs
- Color-coded boxes help meet standards as part of a complete HACCP Program
- Follow ServSafe® recommended stacking order of:
  - Clear (cooked foods & dairy products) on top shelves
  - Green boxes (fresh fruits & vegetables)
  - Blue (raw fish and seafood)
  - Red boxes (storing raw meats)
  - Yellow boxes (raw poultry) at the bottom of stack

ServSafe® is a registered trademark of the National Restaurant Association



## Storplus Food Storage Boxes & Lids

**Reinforced Lid Corners**  
Help prevent chipping and cracking

**Textured Lid**  
Non-slip textured finish for longer wear

**Easy-Grip Reinforced Handles**  
Reinforcement ribs add strength and rigidity for a more secure grip

**Textured Finish**  
Non-slip textured finish on corners, sides, and bottom of box reduce scratches - keep boxes looking newer, longer

**Date Indicators**  
Convenient date indicators on all four sides and on lids for easy recognition



Use clear boxes for dairy foods, ready-to-eat, and cooked foods

**Material Choices**  
Available in durable polycarbonate or practical, economical polyethylene

**"Lock Tight" Stackable/Reversible Lids**  
Secure "bead and socket" latches firmly attach lids to boxes; prevent spills, moisture loss, and contamination

**Capacity Indicators (12" x 18" size only)**  
Allows "prepping" and "portioning" in the same container as transport and storage

**Reinforced Box Corners**  
Help prevent chipping and cracking



Use green boxes for fresh fruits and vegetables



Use blue boxes for raw fish and seafood



Use red boxes for storing raw meats



Use yellow boxes for raw poultry



White(02)



Red(05)



Clear(07)



Green(09)



Blue(14)



Yellow(22)

Prod No	Description	Color	Pack	Cs Wt/Cube
<b>Color-Coded Polycarbonate</b>				
<b>Clear Polycarbonate*</b>				
—	10610 $\Delta$	2 gal 12" x 18" x 3.5 Box	07	6 ea 10.85/1.11
10611C $\Delta$	10611 $\Delta$	3.5 gal 12" x 18" x 6" Box	05, 07, 09, 14, 22	6 ea 15.45/2.12
10612C $\Delta$	10612 $\Delta$	5 gal 12" x 18" x 9" Box	05, 07, 09, 14, 22	6 ea 19.50/2.82
10617C $\Delta$	10617 $\Delta$	12" x 18" Lid	05, 07, 09, 14, 22	6 ea 7.85/0.49
—	10620 $\Delta$	5 gal 18" x 26" x 3.5" Box	07	6 ea 23.40/2.38
10621C $\Delta$	10621 $\Delta$	8.5 gal 18" x 26" x 6" Box	07	6 ea 31.70/4.63
10622C $\Delta$	10622 $\Delta$	12.5 gal 18" x 26" x 9" Box	03, 05, 07, 09, 14, 22	4 ea 27.25/4.70
10623C $\Delta$	10623 $\Delta$	16.6 gal 18" x 26" x 12" Box	03, 05, 07, 09, 14, 22	3 ea 27.40/5.07
10624C $\Delta$	10624 $\Delta$	21.5 gal 18" x 26" x 15" Box	03, 05, 07, 09, 14, 22	3 ea 31.75/7.17
10627C $\Delta$	10627 $\Delta$	18" x 26" Lid	05, 07, 09, 14, 22	6 ea 14.50/1.13
—	10628 $\Delta$	18" x 26" x 5" Colander	07	6 ea 27.50/2.55
—	10629 $\Delta$	18" x 26" Drain Grate	07	6 ea 11.24/0.57
<b>White Polyethylene</b>				
10630 $\Delta$	2 gal 12" x 18" x 3.5" Box	02	6 ea	8.40/1.11
10631 $\Delta$	3.5 gal 12" x 18" x 6" Box	02	6 ea	12.20/2.16
10632 $\Delta$	5 gal 12" x 18" x 9" Box	02	6 ea	15.35/2.82
10637 $\Delta$	12" x 18" "Lock-Tight" Lid	02	6 ea	6.00/0.48
10640 $\Delta$	5 gal 18" x 26" x 3.5" Box	02	6 ea	18.25/2.38
10641 $\Delta$	8.5 gal 18" x 26" x 6" Box	02	6 ea	25.00/4.68
10642 $\Delta$	12.5 gal 18" x 26" x 9" Box	02	4 ea	20.45/4.73
10643 $\Delta$	16.6 gal 18" x 26" x 12" Box	02	3 ea	20.70/5.07
10644 $\Delta$	21.5 gal 18" x 26" x 15" Box	02	3 ea	24.00/7.17
10647 $\Delta$	18" x 26" "Lock-Tight" Lid	02	6 ea	12.10/1.13
10648 $\Delta$	18" x 26" x 5" Colander	02	6 ea	21.30/2.55

NSF Listed products are designated with a  $\Delta$

\*Clear polycarbonate food boxes comes in Clear(07) only

# FOOD STORAGE CONTAINERS

## StorPlus™ Square Food Storage Containers

- Unique reinforced stacking lugs on all four corners help prevent container “lock-up” or jamming when stacked
- Perfect for storing condiments, spices, toppings, leftover or preparation
- Color-coded capacity indicators are listed in both quarts and liters
- Date indicators on container sides and lid help maintain food quality
- Wide, easy-grip handles with drain holes for quicker drying
- Clear polycarbonate containers provide exceptional durability and can withstand temperatures from -40°F to 212°F
- Economical white polyethylene containers withstand temperatures from -40°F to 180°F
- Stackable with other popular brands
- Color-coded, textured snap-on lids fit both the polycarbonate and polyethylene containers
- Textured exterior provides a secure grip
- Smooth interior finish makes clean-up easy
- NSF Listed; dishwasher safe



### Textured Lids

Non-slip texturing provides secure stacking and scratch resistance. Snap-on lid fits both polycarbonate and polyethylene containers and are color-coded to match capacity indicators for quick identification.

### Wide, Easy Grip Handles

Wide, comfortable design with textured finish provides a secure grip. Drain holes in handles allow for quicker drying.

### Date Indicators

On all four sides help maintain food quality and make inventory control easy.

### Spoonable Bottoms

Makes removal of contents easier, helps prevent food waste, and promotes easy clean-up.



### Contents and Date Indicators

Provides convenient space for marking contents and date to help promote product freshness and quality.

### Stacking Lugs

Corner stacking lugs add strength, rigidity, and prevent jamming when stacked. Containers stack with other popular brands.

### Capacity Indicators

Listed in both gallons and liters, are color-coded to match lids for quick identification. Indicators allow prepping, portioning, measuring of contents and ingredients, and inventory control.

### Textured Finish

Non-slip textured finish on corners, edges, and bottom of container reduces scratches to keep containers looking like new longer.

### Economical Space Savers

- Square shape allows for practical storage in the freezer, cooler, or shelf
- Molded-in volume graduations indicate capacity
- Translucent polypropylene offers contact clarity for easy identification of products
- Withstand temperatures from 32° to 170°F
- Economical white polyethylene withstands temperatures from -40° to 180° F
- NSF Listed; dishwasher safe

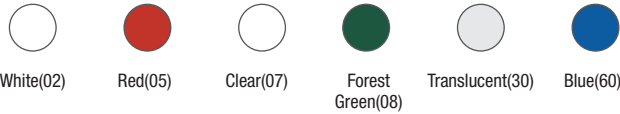

Prod No	Description	Color	Pack	Cs Wt/Cube
<b>StorPlus Square Polycarbonate Food Storage Containers</b>				
10720 $\Delta$	2 qt, 7.13" Sq x 3.81" H Polycarbonate Container	07	6 ea	3.95/0.56
10721 $\Delta$	4 qt, 7.13" Sq x 7.31" H Polycarbonate Container	07	6 ea	6.00/0.73
10722 $\Delta$	6 qt, 8.75" Sq x 7.31" H Polycarbonate Container	07	6 ea	8.15/1.16
10723 $\Delta$	8 qt, 8.75" Sq x 9" H Polycarbonate Container	07	6 ea	9.40/1.20
10724 $\Delta$	12 qt, 11.13" Sq x 8.25" H Polycarbonate Container	07	6 ea	14.00/2.41
10725 $\Delta$	18 qt, 11.13" Sq x 12.56" H Polycarbonate Container	07	6 ea	18.35/3.11
10726 $\Delta$	22 qt, 11.13" Sq x 15.75" H Polycarbonate Container	07	6 ea	22.80/3.61
<b>StorPlus Square Polyethylene Food Storage Containers</b>				
10730 $\Delta$	2 qt, 7.13" Sq x 3.81" H Polyethylene Container	02	6 ea	3.50/0.56
10731 $\Delta$	4 qt, 7.13" Sq x 7.31" H Polyethylene Container	02	6 ea	5.40/0.73
10732 $\Delta$	6 qt, 8.75" Sq x 7.31" H Polyethylene Container	02	6 ea	7.30/1.18
10733 $\Delta$	8 qt, 8.75" Sq x 9" H Polyethylene Container	02	6 ea	8.40/1.23
10734 $\Delta$	12 qt, 11.13" Sq x 8.25" H Polyethylene Container	02	6 ea	12.50/2.41
10735 $\Delta$	18 qt, 11.13" Sq x 12.56" H Polyethylene Container	02	6 ea	16.50/3.11
10736 $\Delta$	22 qt, 11.13" Sq x 15.75" H Polyethylene Container	02	6 ea	20.50/3.61
<b>StorPlus Square Container Lids</b>				
10740 $\Delta$	2-4 qt, 7.31" Sq x .62" H Lid	05	6 ea	1.30/0.13
10741 $\Delta$	6-8 qt, 9" Sq x .62" H Lid	08	6 ea	1.90/0.18
10742 $\Delta$	12-18-22 qt, 11.38" Sq x .62" H Lid	60	6 ea	2.90/0.28
<b>Economical Polypropylene Space Savers</b>				
ST1532 $\Delta$	2 qt, 6.62" Sq x 4.12" H Polypropylene Container	30	12 ea	5.80/0.93
ST1544 $\Delta$	4 qt, 6.62" Sq x 8.12" H Polypropylene Container	30	12 ea	9.46/1.18
ST1556 $\Delta$	6 qt, 8.60" Sq x 6.87" H Polypropylene Container	30	12 ea	11.60/1.85
ST1568 $\Delta$	8 qt, 8.60" Sq x 9.25" H Polypropylene Container	30	12 ea	13.90/2.05
ST1629 $\Delta$	18 qt, 14.18" x 8.31" x 12.75" H Polypropylene Container	30	6 ea	10.40/1.78
<b>Economical Polyethylene Space Savers</b>				
1532 $\Delta$	2 qt, 6.62" Sq x 4.12" H Polyethylene Container	02	12 ea	5.80/0.93
1544 $\Delta$	4 qt, 6.62" Sq x 8.12" H Polyethylene Container	02	12 ea	9.25/1.18
1556 $\Delta$	6 qt, 8.60" Sq x 8.12" H Polyethylene Container	02	12 ea	12.10/1.85
1568 $\Delta$	8 qt, 8.60" Sq x 9.25" H Polyethylene Container	02	12 ea	14.70/2.05
1629 $\Delta$	18 qt, 14.18" x 8.31" x 12.75" H Polyethylene Container	02	12 ea	11.10/1.78
<b>Economical Space Saver Lids</b>				
ST1573	2-4 qt, 6.62" Sq x .25" H Lid	30	12 ea	1.45/0.11
ST1587	6-8 qt, 8.60" Sq x .25" H Lid	30	12 ea	2.86/0.20
ST1630	18 qt, 14.37" x 8.5" x 0.5" H Lid	30	6 ea	2.80/0.23

NSF Listed products are designated with a  $\Delta$

## FOOD STORAGE CONTAINERS

**StorPlus™ Round Containers**

- Super-tough clear polycarbonate for ultimate durability allows easy food content identification at a glance
- Exclusive Carlisle spoonable bottom for increased yield and less food waste
- Tight double-sealing lids protect against spills and extend freshness
- Molded-in capacity indicators in quarts and liters for simple portion and inventory control
- StorPlus containers stack with other major brands for convenient storage; stacking shoulder prevents jamming
- Date indicator lids help maintain food quality and control inventory turns, interchangeable with other brands
- Clear polycarbonate containers can withstand temperatures from -40°F to 212°F
- NSF Listed; dishwasher safe

**Bains Maries**

- Carlisle Bains Marie are the original round food storage containers
- Outside stacking lugs prevent jamming
- Snap-on, air-tight lids are tabbed for easy on and off
- Smooth interior cleans easily, leaving no food traps
- Molded-in handles for easy lifting
- 12, 18, & 22 qt sizes have recessed handles for extra strength and stability in lifting, as well as graduated U.S. measurements shown on the side of the container
- 2, 3.5, 6, & 8 qt sizes can be imprinted
- Clear polypropylene containers are translucent and seamless, offering contact clarity for easy identification of products
- Polypropylene containers withstand temperatures from 32° to 170°F
- Economical white polyethylene containers will withstand temperatures from -40° to 180° F
- NSF Listed; dishwasher safe





White(02)



Red(05)



Clear(07)

Forest  
Green(08)

Translucent(30)



Blue(60)

Prod No	Description	Color	Pack	Cs Wt/Cube
<b>StorPlus Round Food Storage Containers</b>				
10761 $\Delta$	1 qt Round Container	07	12 ea	4.20/0.44
10763 $\Delta$	2 qt Round Container	07	12 ea	6.56/0.67
10764 $\Delta$	4 qt Round Container	07	12 ea	10.87/0.88
10765 $\Delta$	6 qt Round Container	07	12 ea	12.17/1.31
10766 $\Delta$	8 qt Round Container	07	12 ea	14.53/1.45
10767 $\Delta$	12 qt Round Container	07	6 ea	11.24/1.74
10768 $\Delta$	18 qt Round Container	07	6 ea	16.24/2.53
10769 $\Delta$	22 qt Round Container	07	6 ea	20.93/3.23
<b>StorPlus Round Container Lids</b>				
10770 $\Delta$	1 qt Round Lid	05, 08, 30, 60	12 ea	0.40/0.18
10771 $\Delta$	2-4 qt Round Lid	05, 08, 30, 60	12 ea	2.40/0.39
10772 $\Delta$	6-8 qt Round Lid	05, 08, 30, 60	12 ea	3.27/0.43
10773 $\Delta$	12-18-22 qt Round Lid	05, 08, 30, 60	6 ea	3.49/0.46
<b>Bains Marie Polypropylene Containers</b>				
0205 $\Delta$	2 qt Container, 6.56"D x 4.38"H	30	12 ea	5.02/0.71
0355 $\Delta$	3.5 qt Container, 6.56"D x 7.63"H	30	12 ea	7.25/1.11
0605 $\Delta$	6 qt Container, 7.63"D x 8.13"H	30	12 ea	9.35/2.34
0805 $\Delta$	8 qt Container, 7.63"D x 10.75"H	30	12 ea	11.95/3.42
1205 $\Delta$	12 qt Container, 12.25"D x 8.75"H	30	6 ea	8.78/2.24
1805 $\Delta$	18 qt Container, 12.38"D x 13"H	30	6 ea	10.15/3.07
2205 $\Delta$	22 qt Container, 12.25"D x 15.44"H	30	6 ea	12.92/4.20
<b>Bains Marie Polypropylene Container Lids</b>				
0202 $\Delta$	2 – 3.5 qt Lid, 6.69"D x .31"H	30	12 ea	1.26/0.12
0602 $\Delta$	6 – 8 qt Lid, 8.06"D x .38"H	30	12 ea	2.00/0.21
1252 $\Delta$	12 – 18 – 22 qt Lid, 12.38"D x .75"H	30	6 ea	3.10/0.45
<b>Bains Marie Polyethylene Containers</b>				
0200 $\Delta$	2 qt Container, 6.56"D x 4.44"H	02	12 ea	5.15/0.71
0350 $\Delta$	3.5 qt Container, 6.56"D x 7.63"H	02	12 ea	7.60/1.11
0600 $\Delta$	6 qt Container, 7.63"D x 8.13"H	02	12 ea	9.55/2.34
0800 $\Delta$	8 qt Container, 7.625"D x 10.75"H	02	12 ea	12.55/3.42
1200 $\Delta$	12 qt Container, 12.25"D x 8.75"H	02	6 ea	8.70/2.24
1800 $\Delta$	18 qt Container, 12.38"D x 13"H	02	6 ea	10.55/3.07
2200 $\Delta$	22 qt Container, 12.25"D x 15.44"H	02	6 ea	13.09/4.20
<b>Bains Marie Polyethylene Container Lids</b>				
0203 $\Delta$	2 – 3.5 qt Lid, 6.69"D x .31"H	02	12 ea	1.31/0.12
0603 $\Delta$	6 – 8 qt Lid, 8.63"D x .38"H	02	12 ea	1.90/0.21
1202 $\Delta$	12 – 18 – 22 qt Lid, 12.38"D x .75"H	02	6 ea	3.12/0.45

NSF Listed products are designated with a  $\Delta$

# INGREDIENT BINS & FLOOR SYSTEMS



## Ingredient Bins

- Portable, convenient storage bins for large quantities of sugar, flour, etc.
- Lids slide open for easy access
- Heavy-duty, non-marking casters
- Replacement Parts for BIN27, BIN36, & BIN44 shown in chart below

## Floor Rack System

- Interlocking modular system provides a raised surface in dry and cooling storage areas
- Perfect for areas where moisture collects on the floor
- Open design allows for air circulation
- 12" square units lock together, holds up to 3,000 pounds per square foot
- Made of FDA approved high density polyethylene, withstands temperatures from -40° to 180° F
- NSF Listed; dishwasher safe or clean with hose



White(02)



Gray(23)

Prod No	Description	Color	Pack	Cs Wt/Cube
<b>Ingredient Bins</b>				
BIN27	27 gal Capacity Bin, 28.5"L x 12.69"W x 27.88"H	02	1 ea	27.80/6.61
BIN36	36 gal Capacity Bin, 29.5"L x 15.38"W x 28.25"H	02	1 ea	28.40/8.00
BIN44	44 gal Capacity Bin, 29.5"L x 18.13"W x 29"H	02	1 ea	32.30/9.56
BIN27L	Replacement lid for BIN27	—	1 ea	4.50/0.64
BIN36L	Replacement lid for BIN36	—	1 ea	5.65/0.64
BIN44L	Replacement lid for BIN44	—	1 ea	5.85/0.64
<b>Floor Rack</b>				
2710 <span style="color: orange;">Δ</span>	12" x 12" x 1.5" Floor Rack	23	12 ea	19.15/2.09

NSF Listed products are designated with a Δ

Note: Capacities are based on liquid measurements to rim, i.e. flush fill



# WAREWASHING

In foodservice, warewashing is all about efficiency, durability and simplicity. No one makes warewashing easier than Carlisle. We offer every rack, basket and accessory you need to not only get the job done, but to get it done efficiently.

<b>Product</b>	<b>Page</b>
Bus Boxes . . . . .	202
Color-Coded Glass Racks . . . . .	192-194
Cylinders, Dispensers & Carriers . . . . .	200
Dish Racks	
All-Purpose Plate & Tray Rack . . . . .	198
Combination/Flatware Rack . . . . .	198
Cup Racks . . . . .	198
Peg Racks . . . . .	198
Open/Bowl Racks . . . . .	198
Dollies . . . . .	200
Dust Covers . . . . .	201
Glass Rack Sizing Guide . . . . .	195
Glass Racks	
9-Compartment . . . . .	194
16-Compartment . . . . .	192
20-Compartment . . . . .	191
25-Compartment . . . . .	192
30-Compartment . . . . .	191
36-Compartment . . . . .	192
49-Compartment . . . . .	194

<b>Product</b>	<b>Page</b>
Half Size Stack-All Racks . . . . .	200
Hold Down Grid . . . . .	200
OptiClean Dish Racks . . . . .	198
Plaque-A-Rack System . . . . .	196 & 197
Rack Cover . . . . .	201
Rack Dollies . . . . .	200
Save-All Compartmented Bus Boxes . . . . .	202
Sizing Guide . . . . .	195
Specialty Racks	
Bakery Tray & Sheet Pan Rack . . . . .	199
Food Pan/Insulated Meal Delivery Tray Rack . . . . .	199
Plate Cover Rack . . . . .	199
Warewashing Accessories . . . . .	200-202
Washing Baskets, Flatware . . . . .	200

# OPTICLEAN® GLASS RACKS

## Build Your Perfect System – The Easy Way

- OptiClean's basic three-component system of base racks and open and divided extenders allow you to construct the exact configuration you need
- Sure-Lock Extender design makes alterations quick and easy
- The user-friendly product numbering system refers to the exact type of rack you're ordering, without any complicated formulas
- Each number consists of an "R" followed by a descriptor – "G" for Glass, "W" for NeWave, "P" for Peg, etc
- Glass and cup racks are further defined by their number of compartments, ie: RG16 for a 16-compartment glass rack base
- To add extenders to your order, just add a dash and the number of extenders you need to the end of the basic product number, such as "RG16-3" for a 16-compartment glass rack with three extenders (note: each extender adds approximately 1.5" of additional height to the inside compartment of the rack)
- Use the unique Plaque-A-Rack System shown on pages 196 & 197 for the ultimate in easy-to-use rack identification

## Carlisle's Glass Rack Compatibility Chart

- Carlisle's Glass Rack Compatibility Chart is available at [www.carlislefsp.com/findrack](http://www.carlislefsp.com/findrack)
- Once there you can find recommendations for glass racks designed to be used with Anchor Hocking, Cardinal, Libby, and Oneida Glassware as well as Carlisle Tumblers
- Glass Rack recommendations are based on both the measurements provided by each glassware manufacturer and the minimum clearance required for optimum cleaning performance
- Because actual glasses vary in size, you may prefer to use our glass rack sizing guide shown on page 195

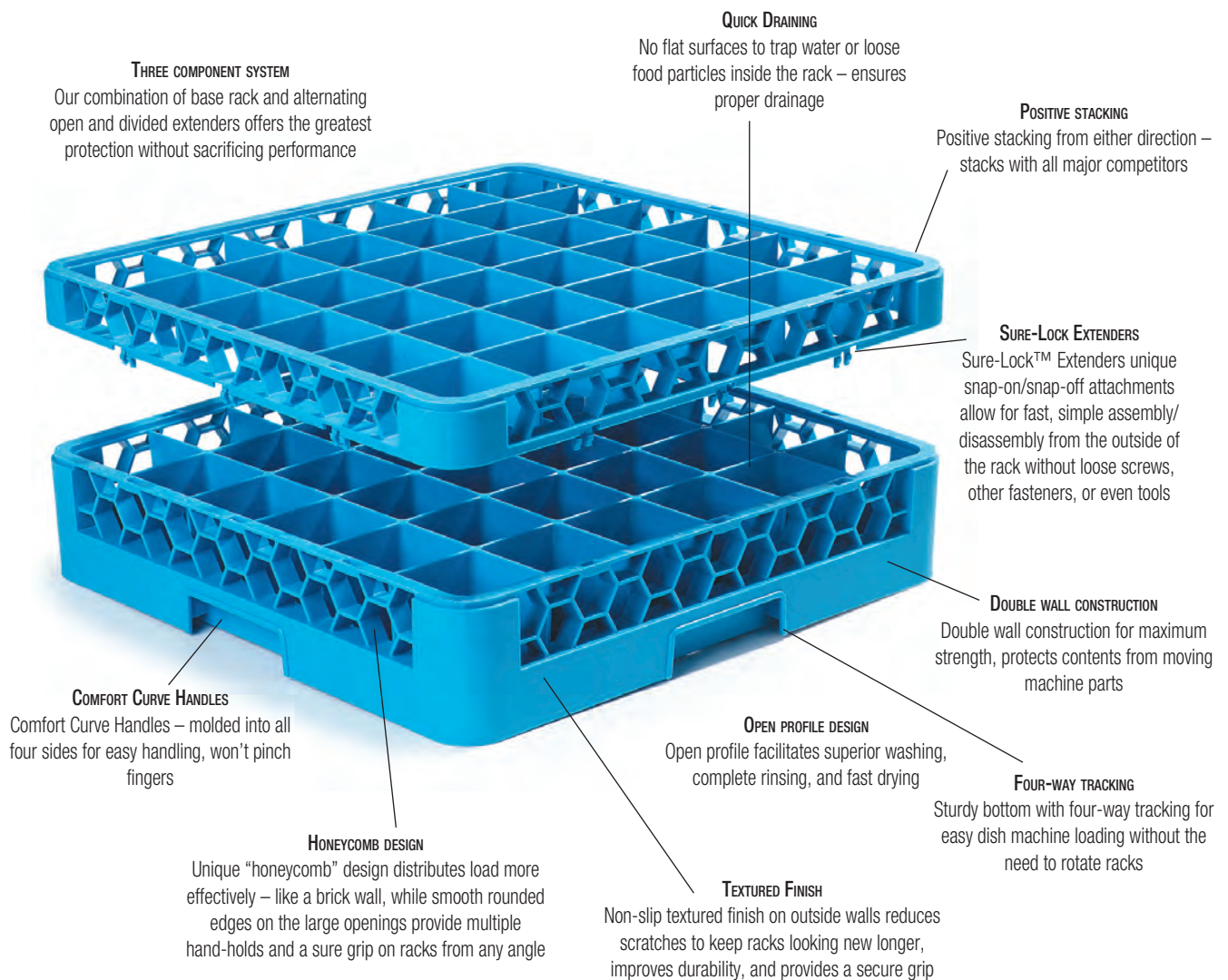

All OptiClean Racks have an outside measurement of 19.75" x 19.75"



### OptiClean NeWave Glass Racks

- Same features as our OptiClean Glass Racks with an added practical interior design that holds 20% more glasses than comparable square racks
- NeWave Glass Racks are a green choice as they help to lower your chemical usage and labor costs
- Rounded design holds glasses securely in place, resulting in less movement and breakage
- NeWave offers two compartment sizes designed to fit the most popular sizes of glassware and tumblers
- NSF Listed



RW20-1C

### NeWave 20-Compartment Glass Racks

- Use for glasses & tumblers

### NeWave 30-Compartment Glass Racks

- Use for glasses & tumblers



RW30-2



Blue(14)

Prod No	Description	Glass Dia**	Glass Height	Color	Pack	Cs Wt/Cube
<b>20-Compartment NeWave Glass Rack - Compartment Size 3.81" Dia</b>						
RW20 $\Delta$	20-Compartment with Integrated Extender	3.56"	4.75"	14	4 ea	28.90/1.35
RW20-1 $\Delta$	20-Compartment with 2 Extenders	3.56"	6.34"	14	3 ea	28.70/5.46
RW20-2 $\Delta$	20-Compartment with 3 Extenders	3.56"	7.94"	14	2 ea	22.00/4.48
RW20-3 $\Delta$	20-Compartment with 4 Extenders	3.56"	9.5"	14	2 ea	25.60/5.30
REW20S	20-Compartment Extender	3.56"	1.5"	14	6 ea	13.90/2.77
<b>30-Compartment NeWave Glass Rack - Compartment Size 3.13" Dia</b>						
RW30 $\Delta$	30-Compartment with Integrated Extender	2.88"	4.75"	14	4 ea	31.80/1.35
RW30-1 $\Delta$	30-Compartment with 2 Extenders	2.88"	6.34"	14	3 ea	31.70/5.46
RW30-2 $\Delta$	30-Compartment with 3 Extenders	2.88"	7.94"	14	2 ea	24.00/4.48
RW30-3 $\Delta$	30-Compartment with 4 Extenders	2.88"	9.5"	14	2 ea	26.70/5.30
REW30S	30-Compartment Extender	2.88"	1.5"	14	6 ea	15.60/2.77

NSF Listed products are designated with a  $\Delta$

\*\*Dimensions shown are for the recommended maximum glass size for the compartment

# OPTICLEAN® GLASS RACKS

## OptiClean Glass Racks & Color-Coded Glass Racks

- Carlisle's OptiClean system includes a full range of glass racks designed to meet your needs
- Full dividers in the base offer complete protection for delicate rims
- Solid dividers in The OptiClean Glass Racks with Color-Coded Extenders make it easy to identify glass rack size or match specific glassware with a specific rack simply by color
- NSF Listed

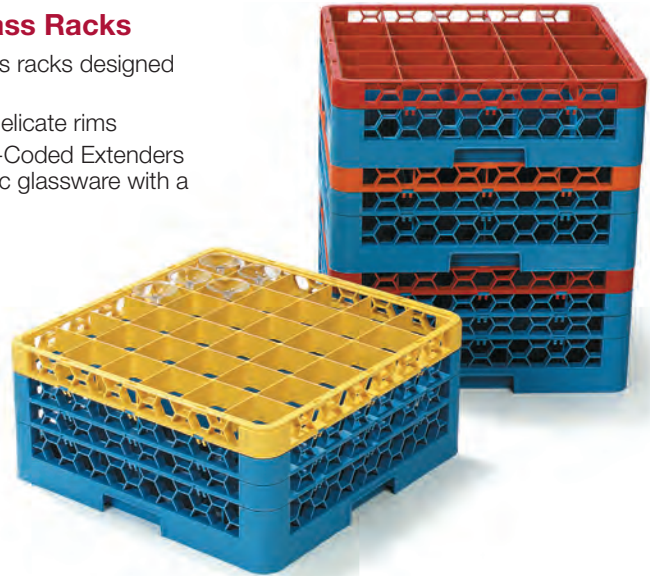

RG16-1



RG16-2C

### 16-Compartment Glass Racks & Color-Coded Glass Racks

- Perfect for large cocktail glasses and delicate wine stems with oversize bowls



### 25-Compartment Glass Racks & Color-Coded Glass Racks

- Use for large diameter beverage glasses, red wine stems, goblets, and most rocks glasses



RG25-1



RG25-1C



RG36-1

### 36-Compartment Glass Racks & Color-Coded Glass Racks

- Use with tumblers, white wine glasses, and other narrow bowl stems



RG36-3C



Prod No	Description	Glass Dia**	Glass Height	Color	Pack	Cs Wt/Cube
<b>16-Compartment OptiClean Glass Rack - Compartment Size 4.44" Square</b>						
RG16 Δ	16-Compartment	4.19"	3.19"	14	6 ea	29.65/5.99
RG16-1 Δ	16-Compartment with 1 Extender	4.19"	4.75"	14	4 ea	25.60/5.42
RG16-2 Δ	16-Compartment with 2 Extenders	4.19"	6.34"	14	3 ea	23.00/5.46
RG16-3 Δ	16-Compartment with 3 Extenders	4.19"	7.94"	14	2 ea	19.30/4.48
RG16-4 Δ	16-Compartment with 4 Extenders	4.19"	9.5"	14	2 ea	20.75/5.30
RE16	16-Compt Divided Extender	4.19"	1.5"	14	6 ea	10.75/2.77
RE*	Open Extender	—	1.5"	14	6 ea	7.75/2.77
<b>16-Compartment OptiClean Color-Coded Glass Rack - Compartment Size 4.44" Square</b>						
RG16-1C Δ	16-Compartment with 1 Extender	4.19"	4.75"	412	4 ea	25.60/5.42
RG16-2C Δ	16-Compartment with 2 Extenders	4.19"	6.34"	412	3 ea	23.00/5.46
RG16-3C Δ	16-Compartment with 3 Extenders	4.19"	7.94"	412	2 ea	19.30/4.48
RG16-4C Δ	16-Compartment with 4 Extenders	4.19"	9.5"	412	2 ea	20.75/5.30
RE16C	16-Compartment Divided Extender	4.19"	1.5"	24	6 ea	10.75/2.77
<b>25-Compartment OptiClean Glass Rack - Compartment Size 3.5" Square</b>						
RG25 Δ	25-Compartment	3.25"	3.19"	14	6 ea	30.30/5.99
RG25-1 Δ	25-Compartment with 1 Extender	3.25"	4.75"	14	4 ea	29.30/5.58
RG25-2 Δ	25-Compartment with 2 Extenders	3.25"	6.34"	14	3 ea	25.20/5.42
RG25-3 Δ	25-Compartment with 3 Extenders	3.25"	7.94"	14	2 ea	21.10/4.51
RG25-4 Δ	25-Compartment with 4 Extenders	3.25"	9.5"	14	2 ea	23.00/5.30
RE25	25-Compartment Divided Extender	3.25"	1.5"	14	6 ea	12.15/2.77
RE*	Open Extender	—	1.5"	14	6 ea	7.75/2.77
<b>25-Compartment OptiClean Color-Coded Glass Rack - Compartment Size 3.5" Square</b>						
RG25-1C Δ	25-Compartment with 1 Extender	3.25"	4.75"	410	4 ea	29.30/5.58
RG25-2C Δ	25-Compartment with 2 Extenders	3.25"	6.34"	410	3 ea	25.20/5.42
RG25-3C Δ	25-Compartment with 3 Extenders	3.25"	7.94"	410	2 ea	21.10/4.51
RG25-4C Δ	25-Compartment with 4 Extenders	3.25"	9.5"	410	2 ea	23.00/5.30
RE25C	25-Compartment Divided Extender	3.25"	1.5"	05	6 ea	12.15/2.77
<b>36-Compartment OptiClean Glass Rack - Compartment Size 2.94" Square</b>						
RG36 Δ	36-Compartment	2.69"	3.19"	14	6 ea	35.55/5.99
RG36-1 Δ	36-Compartment with 1 Extender	2.69"	4.75"	14	4 ea	31.80/5.58
RG36-2 Δ	36-Compartment with 2 Extenders	2.69"	6.34"	14	3 ea	27.10/5.46
RG36-3 Δ	36-Compartment with 3 Extenders	2.69"	7.94"	14	2 ea	22.70/4.45
RG36-4 Δ	36-Compartment with 4 Extenders	2.69"	9.5"	14	2 ea	26.00/5.30
RE36	36-Compartment Divided Extender	2.69"	1.5"	14	6 ea	13.35/2.77
RE*	Open Extender/Hgt: 1.5"	—	1.5"	14	6 ea	7.75/2.77
<b>36-Compartment OptiClean Color-Coded Glass Rack - Compartment Size 2.94" Square</b>						
RG36-1C Δ	36-Compartment with 1 Extender	2.69"	4.75"	411	4 ea	31.80/5.58
RG36-2C Δ	36-Compartment with 2 Extenders	2.69"	6.34"	411	3 ea	27.10/5.46
RG36-3C Δ	36-Compartment with 3 Extenders	2.69"	7.94"	411	2 ea	22.70/4.45
RG36-4C Δ	36-Compartment with 4 Extenders	2.69"	9.5"	411	2 ea	26.00/5.30
RE36C	36-Compartment Divided Extender	2.69"	1.5"	04	6 ea	13.35/2.77

NSF Listed products are designated with a Δ

\* Note: The RE Open Extender can be used with any OptiClean Glass or Dish Rack

\*\*Dimensions shown are for the recommended maximum glass size for the compartment



# OPTICLEAN® GLASS RACKS

## 9-Compartment Glass Racks & Color-Coded Glass Racks

- Use with large brandy snifters, grande margaritas, carafes, and other items with a wide diameter



RG9-1



## 49-Compartment Glass Racks & Color-Coded Glass Racks

- Ideal for juice glasses, narrow champagne flutes, cordials, and shot glasses



RG49-1



RG49-1C



Green(09)



Blue(14)



Lavender(89)



Green Blue(413)



Lavender Blue(414)

Prod No	Description	Glass Dia**	Glass Height	Color	Pack	Cs Wt/Cube
<b>9-Compartment Glass Rack - Compartment Size 5.81" Square</b>						
RG9 $\Delta$	9-Compartment	5.56"	3.19"	14	6 ea	28.50/6.21
RG9-1 $\Delta$	9-Compartment with 1 Extender	5.56"	4.75"	14	4 ea	23.65/5.80
RG9-2 $\Delta$	9-Compartment with 2 Extenders	5.56"	6.34"	14	3 ea	21.35/5.55
RG9-3 $\Delta$	9-Compartment with 3 Extenders	5.56"	7.94"	14	2 ea	18.00/4.54
RE9	9-Compartment Divided Extender	5.56"	9.5"	14	6 ea	9.60/2.77
RE*	Open Extender	—	1.5"	14	6 ea	7.75/2.77
<b>9-Compartment Color-Coded Glass Rack - Compartment Size 5.81" Square</b>						
RG9-1C $\Delta$	9-Compartment with 1 Extender	5.56"	4.75"	413	4 ea	23.65/5.80
RG9-2C $\Delta$	9-Compartment with 2 Extenders	5.56"	6.34"	413	3 ea	21.35/5.55
RG9-3C $\Delta$	9-Compartment with 3 Extenders	5.56"	7.94"	413	2 ea	18.00/4.54
RE9C	9-Compartment Divided Extender	5.56"	1.5"	09	6 ea	9.60/2.77
<b>49-Compartment Glass Rack - Compartment Size 2.38" Square</b>						
RG49 $\Delta$	49-Compartment	2.13"	3.19"	14	6 ea	37.85/6.21
RG49-1 $\Delta$	49-Compartment with 1 Extender	2.13"	4.75"	14	4 ea	31.30/5.80
RG49-2 $\Delta$	49-Compartment with 2 Extenders	2.13"	6.34"	14	3 ea	31.50/5.55
RG49-3 $\Delta$	49-Compartment with 3 Extenders	2.13"	7.94"	14	2 ea	23.20/4.45
RE49	49-Compartment Divided Extenders	2.13"	1.5"	14	6 ea	14.90/2.77
RE*	Open Extender	—	1.5"	14	6 ea	7.75/2.77
<b>49-Compartment Color-Coded Glass Rack - Compartment Size 2.38" Square</b>						
RG49-1C $\Delta$	49-Compartment with 1 Extender	2.13"	4.75"	414	4 ea	31.30/5.80
RG49-2C $\Delta$	49-Compartment with 2 Extenders	2.13"	6.34"	414	3 ea	31.50/5.55
RG49-3C $\Delta$	49-Compartment with 3 Extenders	2.13"	7.94"	414	2 ea	23.20/4.45
RE49C	49-Compartment Divided Extender	2.13"	1.5"	89	6 ea	14.90/2.77
RE*	Open Extender	—	1.5"	14	6 ea	7.75/2.77

NSF Listed products are designated with a  $\Delta$

\* Note: The RE Open Extender can be used with any OptiClean Glass or Dish Rack

\*\*Dimensions shown are for the recommended maximum glass size for the compartment



## Glass Rack Sizing Guide

### Instructions:

1. Place glass upside down on top of the middle circle of the sizing guide; center of the glass (or the stem on stemware) should be over the center of the guide.
2. Look down on the base of the glass.
3. Note the smallest square on the guide where the largest outside diameter of your glass lines up completely within the square without touching it – this is the number of compartments your rack needs to have.
4. Place lip of glass against the base line of the vertical guide on the right-hand side of the page with the base/foot of the glass pointing straight up towards the top of the page.
5. While holding the glass against the vertical guide, note where the base/foot of the glass lines up on the vertical guide – the next line above the base/foot on the guide indicates the number of extenders your rack will require.
6. Carlisle's unique OptiClean Warewashing rack system allows you to build the perfect rack for any application. Glasses with a maximum height exceeding 10.5" will need more than five extenders. Custom racks requiring more than five extenders are available for order by contacting a Carlisle FoodService Products customer service representative. Each extender adds approximately 1.5" of additional height to the inside compartment of the rack.

For glasses with a maximum diameter exceeding 6", Carlisle FoodService Products recommends using the RTP peg rack. The RTP peg rack can be custom ordered to accommodate any glass height.

Please contact a Carlisle FoodService Products customer service representative to place your order, or for more information about building the ideal rack for your needs.

### Glass Rack Sizing Guide

Note: Guide below represents diameter/size of recommended glass to fit corresponding compartment.

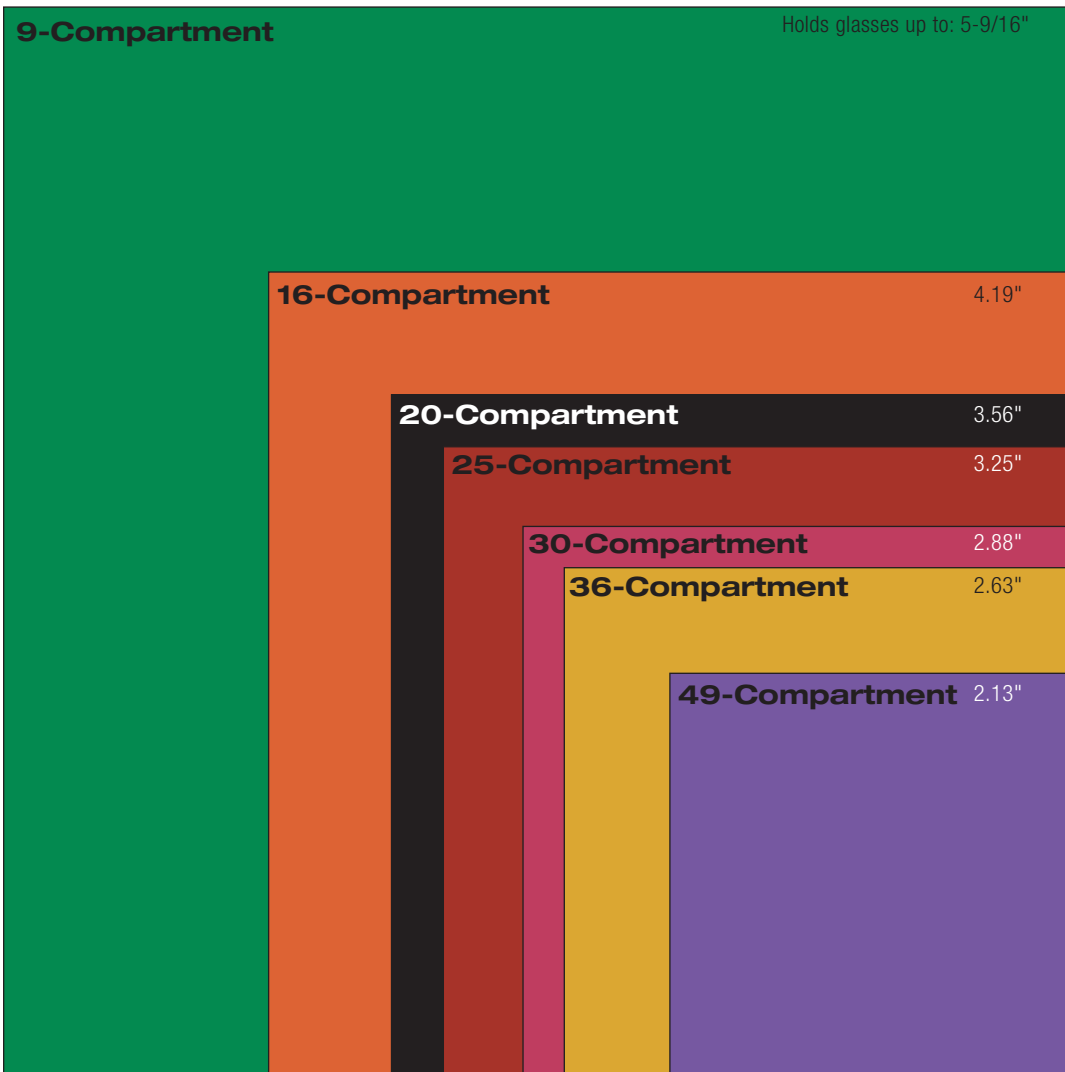

9.5"  
Glass Rack with  
4 Extenders or  
NeWave with 3  
Extenders

7.946"  
Glass Rack with  
3 Extenders or  
NeWave with 2  
Extenders

6.34"  
Glass Rack with  
2 Extenders or  
NeWave with 1  
Extender

4.75"  
Glass Rack with  
1 Extender or  
NeWave Base

3.19"  
Base

# PLAQUE-A-RACK

Carlisle's Plaque-A-Rack System is the proven standard in custom rack labeling. And, with our color-coded racks (shown on pages 192-194) Carlisle offers the widest combination of identification options in the industry. You can identify your racks by contents, silhouette, name, location (usage/storage), and color code for a totally customized system. Order custom designed plaques to meet your own unique needs. The highly visible plaques fit up to three across on both bases and extenders for complete versatility. Plaques can be easily added, removed, or changed as needed. Plaque-A-Rack is also the only rack identification system that will allow you to easily put identifiers in multiple languages on the same rack. Sturdy reusable plaques are made from a high-impact plastic and won't come off during the normal wear and tear of daily usage – offering a permanent identification system for the life of your racks.



Plaque example shown above: XRG25-2 with 203, 303, 103

- Plaque-A-Rack provides four ways to customize your Glass Rack System:
  - glassware silhouette
  - glassware style by name
  - location of glassware usage or storage
  - custom color coding options
- Plaques are hot stamped with either a glassware silhouette, glassware name, usage, or storage area location
- Plaques are Carlisle Blue(14), unless otherwise specified
- All plaques are 3" long by 1" high
- Racks can be ordered with up to three possible plaque imprints
- There is a \$3.36 U.S. list price charge per rack for each Plaque-A-Rack order (includes 2 plaques on 2 sides); special orders for plaques on all four sides have a \$6.72 U.S. list price (includes 2 plaques on 4 sides)
- Plaques may also be ordered separately at \$0.84 U.S. list price each
- Plaques are placed horizontally on two opposite sides of the rack along the top most edge
- Plaques snap on for a tight fit; won't fall off during normal use
- Plaques can be removed if necessary and are re-usable
- Allow ten working days for shipment of your standard order
- Plaques sold in full case quantities only
- Custom plaque imprints available; minimum order 24 pieces
- Please allow 4-6 weeks from approval of sample for custom plaques
- Custom imprinted plaques are \$0.84 U.S. list price each with an additional \$50 U.S. net price setup fee and a \$16 U.S. net price film charge
- An additional \$115 U.S. net price dye charge will apply to any plaque order that does not include racks
- For custom color coding, please specify which color is to be used for each rack
- All plaque sales are final

## How To Order Racks With Imprinted Plaques

Follow instructions below and refer to the charts on the facing page for catalog numbers.

Step 1: Choose the glass rack that best fits your glassware.

Step 2: Plaque-A-Rack glass racks are identified by an "X" preceding the standard glass rack catalog number (example: "X"RG25-1 25-Compartment Plaque-A-Rack glass rack with one extender).

Step 3: Choose the different imprints you want from the types of plaque imprints available.

- **Silhouette**
- **Name of glassware**
- **Location**

Plaques Are Available In Blue(14)

Plus— six custom colors

**Standard Color:**



Blue (14) with White type

**Custom Colors:**



Dark Blue (60) with White type



Green (09) with White type



Orange (24) with Black type



Purple (68) with White type



Red (05) with White type



Yellow (04) with Black type

Step 4: Place the three digit plaque catalog imprint product number next to the standard glass rack catalog number.

EXAMPLE:

Rack Choice: RG25-1

Silhouette: Red Wine













Glassware Name: Red Wine

Location: Service Bar















Catalog No.: XRG25-1      204      304      104

LOCATION	
CAT. NUMBER	IMPRINT
100	(BLANK)
101	KITCHEN
102	DINING
103	BANQUET
104	SERV. BAR
105	POOLSIDE
106	STORAGE
107	RM SERV
108	BALLROOM
109	BAR
110	HOUSEKEEPING

GLASS RACK		
CATALOG NUMBER		
XRG16	XRG25-2	XRG36-4
XRG16-1	XRG25-3	XRG9
XRG16-2	XRG25-4	XRG9-1
XRG16-3	XRW30	XRG9-2
XRG16-4	XRW30-1	XRG9-3
XRW20	XRW30-2	XRG49
XRW20-1	XRW30-3	XRG49-1
XRW20-2	XRG36	XRG49-2
XRW20-3	XRG36-1	XRG49-3
XRG25	XRG36-2	
XRG25-1	XRG36-3	

SILHOUETTE	
CAT.#	IMPRINT
PLQ	(BLANK)
201	
202	
203	
204	
205	
206	
207	
208	
209	
210	
211	
212	
213	

NAME OF GLASS	
CAT.#	IMPRINT
PLQ	(BLANK)
301	CHAMPAGNE
302	CHAMPAGNE
303	WHITE WINE
304	RED WINE
305	ROCKS
306	WATER
307	COOLER
308	PILSNER
309	STEIN
310	PARFAIT
311	BRANDY
312	TULIP
313	SOUR

SILHOUETTE	
CAT.#	IMPRINT
214	
215	
217	
218	
219	
221	
222	
223	
224	
226	
227	
228	
229	
230	
235	

NAME OF GLASS	
CAT.#	IMPRINT
314	MUG
315	FOOTED CUP
317	HI BALL
318	ICED TEA
319	FLUTED
321	GOBLET
322	WINE
323	MARGARITA
324	BEER
326	HURRICANE
327	MARTINI
328	CORDIAL
329	DESSERT
330	CUP
335	OLD FASHION
633	COFFEE CUP

## DISH & SPECIALITY RACKS

### OptiClean Dish Racks

- OptiClean Dish Racks offer the safest and most sanitary cleaning choices for everything from the most fragile tableware to heavy-duty kitchen items such as utensils and cutlery
- They offer the same great features such as sturdy double wall construction and Comfort Curve™ Handles molded into all four sides
- NSF Listed

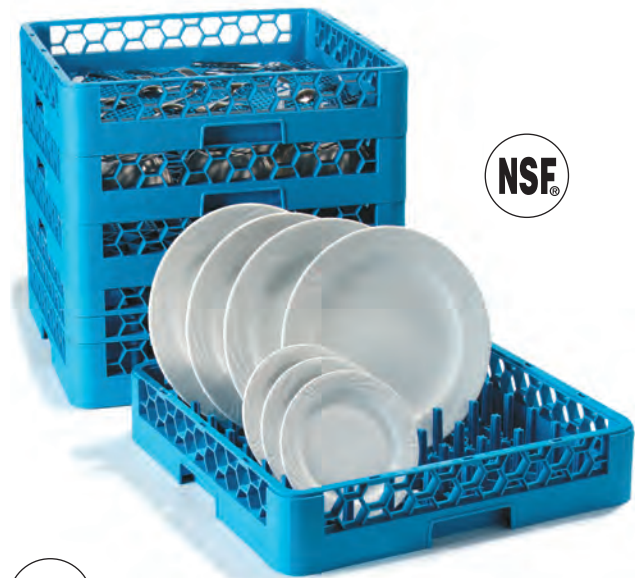

### OptiClean Peg Racks

- Holds plates, trays, and platters at the best angle to take full advantage of today's multiple spray, high pressure dishwashers
- Plate locks hold dishes firmly in place to protect delicate rims, reduce chipping and breakage
- Use with additional Open Extenders (RE) to create the perfect rack for irregular or oversize drinkware
- NSF Listed



### OptiClean Tall Peg Plate & Tray Rack

- Extra tall 2.94" pegs are ideal for charger plates, pasta bowls, large platters, and trays

### OptiClean Open End Peg Rack

- Tall 2.94" pegs with open ended design hold all types of trays, standard size baking sheets and other long items



RB



RF



RC20-1

### OptiClean Open/Bowl Rack

- Sturdy open bottom rack is ideal for all large bowls, containers, brushes, cookware, and cutlery

### Combination/Flatware Rack

- Bottom grid allows for free flow of water and air
- Keeps flatware in place for thorough washing and drying
- Perfect for ramekins, and other small items
- NSF Listed

### Cup Racks

- Tilted design promotes thorough washing of rims and interiors
- Encourages bases to drain more efficiently
- 16-Compartment holds larger diameter cups and mugs in tilted position; compartment size: 4.34" x 4.34"
- 20-Compartment works with most standard size cups; compartment size: 4.34" x 3.41"
- NSF Listed



### OptiClean Bakery Tray & Sheet Pan Rack

- Rack securely holds sheet or bun pans low enough to fit standard height dish machine openings
- Contents are angled to take full advantage of multiple spray arms
- NSF Listed



RSP

### OptiClean Food Pan/Insulated Meal Delivery Tray Rack

- Accommodates all sizes of 2.5" deep food pans and standard steam table inserts
- Racks are angled for thorough cleaning
- Perfect for health care or correctional facilities using insulated meal delivery compartment trays
- NSF Listed

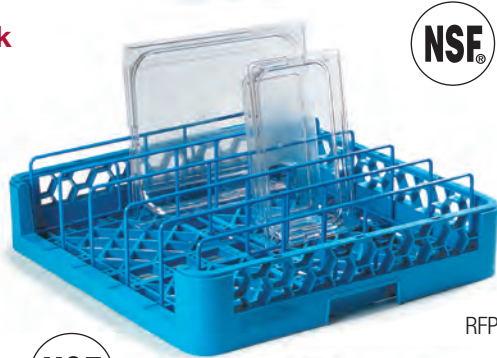

RFP

### OptiClean Plate Cover Rack

- Use with plate covers, dishwasher safe insulated dome covers, or dishwasher safe pellet bases
- Specially designed insert keeps contents separated during washing
- NSF Listed



RPC



Blue(14)

Prod No	Description	Glass Dia	Glass Height	Color	Pack	Cs Wt/Cube
<b>Peg Racks &amp; Extender</b>						
RP	All-Purpose Plate & Tray Rack	—	—	14	6 ea	29.00/5.66
RTP $\Delta$	Tall Peg Plate & Tray Rack	—	—	14	6 ea	27.70/5.74
ROP $\Delta$	Open End Peg Rack	—	—	14	6 ea	26.75/5.87
RE*	Open Extender	—	—	14	6 ea	7.75/2.77
<b>Open/Bowl Rack &amp; Extender</b>						
RB $\Delta$	Open/Bowl Rack	—	—	14	6 ea	22.25/6.18
RE*	Open Extender	—	—	14	6 ea	7.75/2.77
<b>OptiClean Combination/Flatware Rack</b>						
RF $\Delta$	Combination/Flatware Rack	—	—	14	6 ea	25.15/5.93
RE*	Open Extender	—	—	14	6 ea	7.75/2.77
<b>Cup Racks</b>						
RC16 $\Delta$	16-Compartment Cup Rack	—	—	14	6 ea	32.00/5.99
RC16-1 $\Delta$	16-Compartment Cup Rack with 1 Open Extender	—	—	14	4 ea	24.85/5.55
RC20 $\Delta$	20-Compartment Cup Rack	—	—	14	6 ea	32.20/5.93
RC20-1 $\Delta$	20-Compartment Cup Rack with 1 Open Extender	—	—	14	4 ea	25.60/5.77
<b>Bakery Tray &amp; Sheet Pan Rack</b>						
RSP $\Delta$	Bakery Tray & Sheet Pan Rack	—	—	14	3 ea	19.20/3.28
<b>Food Pan/Insulated Meal Delivery Tray Rack</b>						
RFP $\Delta$	Food Pan/Insulated Meal Delivery Tray Rack	—	—	14	3 ea	20.50/4.23
<b>Plate Cover Rack</b>						
RPC $\Delta$	Plate Cover Rack	—	—	14	3 ea	21.60/3.94

NSF Listed products are designated with a  $\Delta$

\* Note: The RE Open Extender can be used with any OptiClean Glass or Dish Rack

## OPTICLEAN® ACCESSORIES

**Hold Down Grid**

- Use with small, light-weight, or delicate items to prevent them from being displaced by high pressure sprayers
- Snaps down securely and fits all OptiClean Glass & Dish Racks



C93

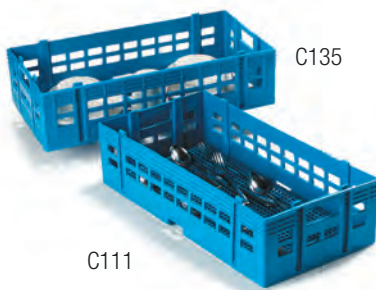

C111

**Half Size Stack-All™ Racks**

- Compact 10" x 19.75" size will work in any 19.75" dishwasher
- Sturdy single wall construction
- Open design for superior water and air circulation
- Made of high impact polypropylene
- NSF Listed

**Perma-Sil™ Cylinders & Carriers****Flatware Cylinders**

- Meshed bottom and open sides are best for the dispersion of water and air; ideal for washing or storing flatware

**Carriers**

- Heavy gauge wire construction is chrome plated
- Vinyl-coated insulated handle



C35P

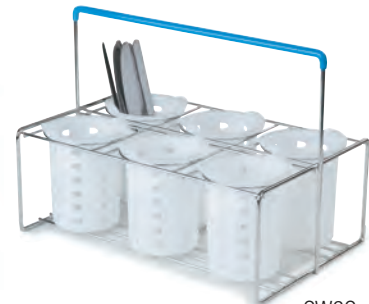

CW6C

**Perma-San™ Flatware Washing Baskets**

- Open design for easy cleaning of vertically stored flatware
- Use with RF Flatware Rack or RB Open/Bowl Rack as part of a complete flatware sanitizing system
- Tough polypropylene material resists grease and detergents
- NSF Listed



C32P1

C32P2



C2236H

C2220A

**E-Z Glide™ Rack Dollies****Aluminum Dollies**

- Hold and transport any 19.75" square stack of glass racks
- Large 4" ball bearing swivel casters with non-marking rubber wheels
- 300 lb weight capacity

**Polypropylene Dollies**

- C2236/C2236H injection molded dollies squared corners are designed to hold any standard 19.75" racks including older style square racks
- 350 lb weight capacity
- Dollies trap water from wet racks; convenient drain feature makes emptying water easy

## OptiClean Dust Covers

- Heavy-duty vinyl covers keep tableware clean during storage
- Easily converts warewashing racks into storage racks
- Combine with E-Z Glide Dollies and Rack Covers (shown left) for a complete storage system



RDC

## OptiClean Rack Cover

- Hard cover protects rack contents during storage



RHC



White(02)    Black(03)    Clear(07)    Blue(14)    Chrome(38)

Prod No	Description	Glass Dia	Glass Height	Color	Pack	Cs Wt/Cube
<b>Hold Down Grid</b>						
C93 $\Delta$	Vinyl Coated Wire Grid	—	—	14	6 ea	22.00/1.29
<b>Half Size Stack-All Racks</b>						
C135 $\Delta$	Open Bowl/Cup/Glass Rack	—	4.5"	14	6 ea	15.80/3.97
C111 $\Delta$	Flatware Rack	—	4.5"	14	6 ea	17.20/3.91
<b>Perma-Sil Cylinders &amp; Carriers</b>						
C35P	Poly Cylinder	—	—	02	12 ea	3.30/0.86
CW6C	6-Compartment Portable Carrier	—	—	38	6 ea	23.00/5.25
C32P1	Flatware Basket without Handles	—	—	14	6 ea	15.60/4.13
C32P2	Flatware Basket with Handles	—	—	14	6 ea	17.00/4.13
<b>E-Z Glide Rack Dollies</b>						
C2220A	Open Aluminum Dolly, No Handle	—	—	14	1 ea	13.50/1.92
C2222A	Open Aluminum Dolly with Handle	—	—	14	1 ea	18.50/3.37
C2236	Warewashing Rack Dolly, No Handle	—	—	03, 14	1 ea	18.50/2.83
C2236H	Warewashing Rack Dolly with Handle	—	—	03, 14	1 ea	22.70/4.35
C2237	Handle for C2236 & C2236H	—	—		1 ea	5.80/1.22
C2222C	Replacement Caster for C2220A & C2222A	—	—		1 ea	2.70/0.21
C2222HD	Handle for C2220A & C2222A	—	—		1 ea	7.00/3.37
<b>Rack Cover</b>						
RHC	Rack Cover	—	—	02	1 ea	2.75/0.35
<b>Dust Covers</b>						
RDC $\nabla$	36" Long Rack Dust Cover	—	—	07	3 ea	4.65/0.57
RDC1 $\nabla$	48" Long Rack Dust Cover	—	—	07	3 ea	5.75/0.60

NSF Listed products are designated with a  $\Delta$

**WARNING:** Products identified on this page with the following symbol  $\nabla$  contain chemicals, including one or more phthalates, known to the State of California to cause cancer and birth defects and other reproductive harm.

# WAREWASHING ACCESSORIES

## Save-All™ Compartmented Bus Boxes

- Silverware tray and heavy-duty bus boxes feature contoured handles for easy handling
- Scuff, grease, and stain-resistant
- Silverware Tray measures 21.25" x 11.5" x 3.75" H
- 0386 Save-All Bus Box has separate compartments, one for flatware, one for plates and debris; measures 22" x 17" x 5" H
- Dishwasher safe



## Bus Boxes

- Unique reinforced rims reduce bending, bowing, and breaking – protecting your valuable tableware investment
- Comfort Curve™ handles for a sure, comfortable grip
- Contour lid design allows easy box-on-box stacking
- 44010, 44011, 44012 in white are NSF Listed



44011SKD



Brown(01)



White(02)



Black(03)



Gray(23)

Prod No	Description	Color	Pack	Cs Wt/Cube
<b>Save-All Compartmented Bus Boxes</b>				
1071	Save-All Silverware Tray	23	6 ea	10.53/1.99
0386	Save-All Bus Box	23	12 ea	34.90/3.68
<b>Bus Boxes</b>				
44010	Bus Box 15" x 20" x 5" Deep	01, 02, 03, 23	12 ea	24.80/3.49
44011	Bus Box 15" x 20" x 7" Deep	01, 02, 03, 23	12 ea	26.56/3.82
44012	Universal Lid	01, 02, 03, 23	12 ea	12.90/0.95
44010SKD*	Bus Box Skid 15" x 20" x 5" Deep	03, 23	300 ea	585.00/73.94
44011SKD*	Bus Box Skid 15" x 20" x 7" Deep	03, 23	240 ea	550.08/64.17

\*Note: 44010SKD, 44011SKD cannot ship UPS/FedEx Ground





# CLEANING TOOLS

Carlisle has the right professional grade cleaning tools to help you run a smarter, safer and more profitable operation. Our outstanding selection offers innovative, hard-working products from special equipment brushes to butcher block brushes. Carlisle is the only company you need for all of your cleaning tool needs.

<b>Product</b>	<b>Page</b>
21 Key Brushes . . . . .	.204
All Purpose Utility Scrub Brushes . . . . .	.210
Atlas Multi-Purpose Brushes . . . . .	.206
Bake Pan Lip Brush . . . . .	.206
Butcher Block Brushes . . . . .	.217
Clean-Up Brushes . . . . .	.211
Counter Top & Radiator Brushes . . . . .	.220
Cutter Brush . . . . .	.215
Cutting Board Brush . . . . .	.206
Dish Brushes . . . . .	.207
Dusters . . . . .	.220
Ergonomic Hand Scrubs . . . . .	.210
Grill Bricks, Screens & Polishing Pads . . . . .	.216
Hand Held Window Squeegees . . . . .	.219
Handle Guide . . . . .	.220
Hand & Nail Brushes . . . . .	.209
High Temperature Equipment Brushes . . . . .	.212
Hot Dog Roller Brush . . . . .	.215

<b>Product</b>	<b>Page</b>
Iron Handle Brush . . . . .	.208
Large Sponge . . . . .	.218
Low Temperature Equipment Brushes . . . . .	.212
Meat Slicer Cleaning Tool . . . . .	.215
Microfiber . . . . .	.218
Oven/Broiler Brushes & Scrapers . . . . .	.214
Polypropylene Block Kitchen Brushes . . . . .	.210
Scratch Brushes . . . . .	.216
Scrubs & Sponges . . . . .	.207
Sparta Bottle & Jar Brushes . . . . .	.208
Sparta Coffee Service Brushes . . . . .	.212
Sparta Glass Washing Brushes . . . . .	.208
Sparta Spectrum Series . . . . .	.205
Spouts, Pumps & Valves . . . . .	.213
Square Steri- & Suds-Pails . . . . .	.218
Toothbrush Style Utility Brushes . . . . .	.216
Window Scrapers . . . . .	.219

# FOOD SAFETY



Maintain a healthy foodservice environment with the Sparta® 21 Key brush solution!

- Prevents cross-contamination with designated brushes for specific areas and tasks
- Provides a basic guideline for stocking your kitchen with the brushes you need



## Pastry/Basting Brushes



**#1 Hot use**  
4037400



**#2 Cold use**  
40401



**#3 Silicone Basting Brush**  
4040505

## Wet Floor Cleaning



**#4 24" Double Foam Rubber Floor Squeegee**  
40082



**#5 Hi-Lo™ Floor Scrub**  
40423

## Dry Floor Cleaning



**#6 Duo-Sweep™ Angle Broom**  
36885



**#7 24" Omni Floor Sweep**  
41881

## Food Preparation



**#8 Vegetable Brush**  
40164

## General Cleanup



**#9 8" Polyester Scrub Brush**  
40541



**#10 20" Polyester Scrub Brush**  
40501



**#11 6" Cutting Board Brush**  
40521



**#12 Scratch Brush with Scraper**  
40671



**#13 Boiler Master Brush**  
40290



**#14 L-Tipped Teflon Fryer Brush**  
40111

## Beverage Service



**#15 12" Carafe/Bottle Brush**  
40000



**#16 Coffee Decanter Brush**  
40025

## Drain Maintenance



**#17 Floor Drain Brush**  
40146



**#18 36" Plastic Drain Brush Handle**  
40236



**#19 Drain Opening Tool**  
40144

## Washroom/Personal Hygiene



**#20 Hand and Nail Brush**  
40020



**#21 Polyester Bowl Brush**  
40140

Visit [www.carlislefsp.com](http://www.carlislefsp.com) for more information and a complete product listing.

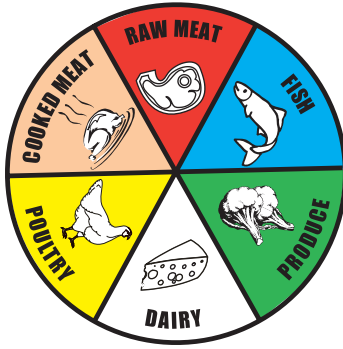

The key to running a successful foodservice operation is all in the details. You know the one detail your customers pay the most attention to is cleanliness. Over 75% of consumers have said that they have had a bad experience in a restaurant they thought wasn't clean. Of those, 80% never complained – but they also never went back. Your customers take the cleanliness of your operation seriously, just as you take their health and safety seriously too.

In this day of rapid turnover, constant training issues, and ever increasing concern over foodborne illness you need cleaning policies that are simple to understand, procedures that are easy to teach, and HACCP routines that are easy to implement and monitor.

Carlisle has been a leader in foodservice and food processing sanitation for decades. Our Sparta brand brushes are the literally the industry standard for cleaning foodservice and food processing operations the world over. With the most specialized tools designed for specific applications, Carlisle has exactly what you need for any cleaning task.

The three most critical cleaning issues that any good defense against preventable foodborne illness concentrates on are:

- Frequent and thorough hand washing by all employees
- Keeping food prep and food contact surfaces clean and sanitized
- Taking simple steps to identify and eliminate cross-contamination hazards

## 21 Key Brushes

Our 21 Key Brush Program represents the basic selection that every foodservice operation needs. It covers front-of-house floor care and general cleaning, back-of-house equipment and food prep station maintenance, and even personal hygiene and restroom care. One of these basics is our Hand & Nail Brush. It is specifically designed to clean where even people with good habits might miss. One should be at every hand wash station you have.

## Kitchen Brush Guide (pages 290 & 291)

This quick and easy visual reference helps you pick out all of the specialty brushes you need to keep the equipment you own clean and up to code - and your prep areas sparkling. Don't see exactly what you want? No problem. Carlisle's knowledgeable staff can help you and your dealer select the right tool for the job from our thousands of options. We can even help you with brushes designed to your unique specifications.

## Sparta Spectrum Series

The original Sparta Spectrum color-code system takes the guess work out of cross-contamination prevention and helps you identify potential problems at a glance – before they have a chance to become an issue. This full-line of Brushes and Cleaning Tools coordinate with other products like our unique color-coded StorPlus Food Boxes, Spectrum Cutting Boards, and other industry standard coded tools to help you set-up easy to understand and train zone/task isolation practices.

- Blue – raw seafood
- Green – raw produce
- Red – raw meats
- Yellow – raw poultry
- Tan – cooked foods
- White – dairy



# SMALLWARES BRUSHES

## Atlas Multi-Purpose Brushes

- Round or oval head Atlas brushes for cleaning steam kettles, vats, beverage servers, pots, pans, crocks, and tanks
- Rounded heads and ends protect against scratching and clean in all directions
- Medium stiff polyester bristles provide aggressive cleaning
- Base resins used to produce blocks and bristles are made of FDA compliant materials

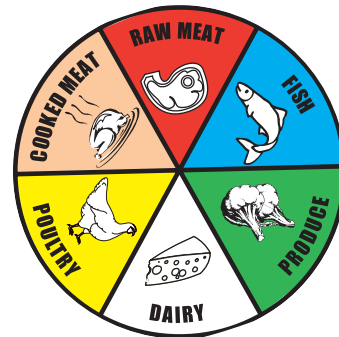

## Cutting Board Brush

- Ergonomically shaped handles and crimped staple set polyester bristles are rugged and will not absorb food oils or moisture



40024

## Bake Pan Lip Brush

- Easy cleaning of rolled lips and edges on baking pans
- Stiff polyester bristles patterned in a flat V-shape for maximum pan contact
- Plastic block with contoured handle provides a convenient grip and protects hands from metal edges on pans and other equipment



### Scrubs & Sponges

- 36752 and 36753 are a long-lasting 400 series stainless that won't rust or splinter
- 36396 is not recommended for coated cookware, soft plastics, fine china or polished stainless steel as scratching can occur

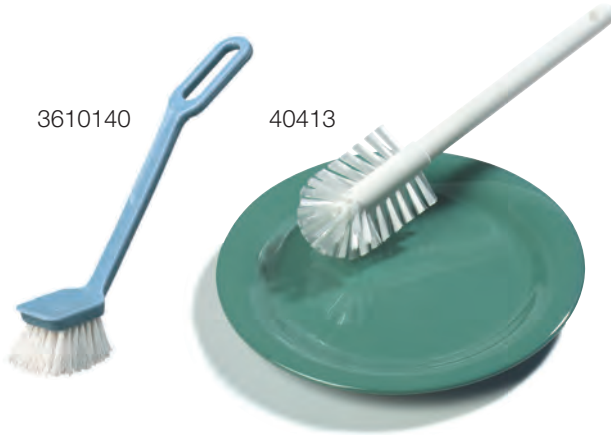

### Dish Brushes

- 40413 has a 180° stapleset brush head and full end bristles to prevent splash back when in use cleaning dishes, utensils and fry pans
- 367600TC has a flattened side to cover the surface area better and help remove food residue



Prod No	Description	Recommended For Cleaning	Color	Pack	Cs Wt/Cube
<b>Multi-Purpose Brushes</b>					
40000	12" Handle, 2.75" Round with Soft Polyester Bristles	Drinkware/Dishes	02, 04, 05, 09, 14	12 ea	2.40/0.65
40001	16" Handle, 3.25" Round with Soft Polyester Bristles	Drinkware/Dishes	01, 02, 04, 05, 09, 14, 68	12 ea	5.00/0.65
40002	16" Handle, 3.5" x 5" Oval with Polyester Bristles	Pots/Pans/Tanks	02, 04, 05, 09, 14	6 ea	4.00/0.77
40003	30" Handle, 3.5" x 5" Oval with Polyester Bristles	Pots/Pans/Tanks	02, 04, 05, 09, 14	6 ea	6.75/1.62
40004	16" Handle, 3" Round with Polyester Bristles	Pots/Pans/Tanks	02, 04, 05, 09, 14	6 ea	3.60/0.65
40006	30" Handle, 3" Round with Polyester Bristles	Pots/Pans/Tanks	02, 04, 05, 09, 14	6 ea	5.00/1.62
40005	16" Handle, 4" Round with Polyester Bristles	Pots/Pans/Tanks	02, 04, 05, 09, 14	6 ea	4.55/0.65
40007	30" Handle, 4" Round with Polyester Bristles	Pots/Pans/Tanks	02, 04, 05, 09, 14	6 ea	5.00/1.62
40010	16" Handle, 5" Round with Polyester Bristles	Pots/Pans/Tanks	02, 04, 05, 09, 14	6 ea	5.25/1.06
40008	30" Handle, 5" Round with Polyester Bristles	Pots/Pans/Tanks	02, 04, 05, 09, 14	6 ea	6.75/1.62
<b>Cutting Board Brush</b>					
40521	6" Cutting Board Brush with Polyester Bristles, 1.38" trim	Cutting Boards/Flat Surfaces	02, 04, 05, 09, 14, 25	12 ea	5.20/0.30
<b>Bake Pan Lip Brush</b>					
40024	6" Bake Pan Lip Brush with Polyester Bristles, 1" trim	Baking Pans	02, 04, 05, 09, 14	12 ea	5.00/0.30
<b>Scrubs &amp; Sponges</b>					
36396	9" x 6" x .25" Medium Duty Scour Pad 10 ea/pack, 6 packs/case	Pots/Pans/Equipment	08	6 ea	7.00/0.83
36752	35 g Stainless Steel Scrub, 400 Series 12 ea/pack, 6 packs/case	Pots/Pans/Oven	00	6 ea	7.00/0.47
36753	50 g Stainless Steel Scrub, 400 Series 12 ea/pack, 6 packs/case	Pots/Pans/Oven	00	6 ea	11.50/1.26
365501	8.25" x 4.25" x 2.25" Extra Large Sponge	Dishes	00	24 ea	1.44/2.15
<b>Dish Brushes</b>					
40413	12" Handle Dish Brush with Polyester Bristles, 2.75" trim	Dishes/Utensils	00	12 ea	4.00/0.65
367600TC	11" Handle Dish Brush with Polyester Bristles, 2.75" trim	Dishes/Utensils	02	6 ea	1.90/0.38
3610140	8" Dish & Sink Brush	Dishes/Utensils	00	48 ea	7.68/0.46

## SMALLWARES &amp; HAND BRUSHES

**Sparta® Glass Washing Brushes**

- All plastic construction helps prevent glasses from being chipped or broken and helps seal out moisture
- Positive-suction, molded plastic base provides a tight grip in sinks and on countertops
- Heavy-duty staple set polyester bristles with densely filled dome top holds up to extreme use

40461



40460



41506



40468



40467



40466



40415

**Sparta Bottle & Jar Brushes**

- Wirewound brushes have a small diameter handle and soft bristles for easy and delicate cleaning of jars, bottles, and glasses with smaller openings
- 40415 Bottle Brush is perfect for cleaning wine bottles, ketchup bottles, squeeze bottles, etc.

**Iron Handle Brush**

- Economical Iron Handle Style Scrub Brush has Polypropylene bristles staple set into plastic block
- Pointed edge to allow cleaning in corners

36289



## Hand & Nail Brushes

- Long bristles along sides clean fingers top and bottom while short bristles in center clean under fingernails
- Works better than soap and water alone for cleaning under fingernails where bacteria, dirt, and other contaminants can become trapped
- New improved stiffer center bristles offer a more thorough cleaning
- 40021 kit includes a 5" x 2" brush, cord to secure the brush in place, hanging hook, and an adhesive backed hand washing instruction decal in English and Spanish



### Cash 'N Carry

Selected products also available in a cash 'n carry pack. See page 286.



Standard(00)

White(02)

Black(03)

Prod No	Description	Recommended For Cleaning	Color	Pack	Cs Wt/Cube
<b>Sparta Glass Washing Brushes</b>					
40460	8" Twin Glass Washer, 2.88" trim	Drinkware	03	6 ea	5.00/1.25
40461	8" Triple Glass Washer, 2.88 trim	Drinkware	02, 03	6 ea	10.00/1.87
41506	9.5" Pilsner, Hurricane & Standard Style Triple Glass Washer	Drinkware	00	6 ea	10.15/1.87
40465	Standard Refill Brush	Drinkware	03	12 ea	3.20/0.45
<b>Sparta Bottle &amp; Jar Brushes</b>					
40466	12" Handle Pint Bottle Brush with Polyester Bristles, 2.5" - 3.5" trim	Jars/Carafes/Bottles	00	12 ea	4.00/0.65
40467	16" Handle Quart Bottle Brush with Polyester Bristles, 3" - 4.25" trim	Jars/Carafes/Bottles	02	12 ea	5.00/0.65
40468	16" Handle Half Gallon Brush with Polyester Bristles, 4" - 4.5" trim	Jars/Carafes/Bottles	00	12 ea	5.26/1.28
40415	16.5" Handle Small Bottle Neck Brush with Soft Nylon Bristles	Small Neck Bottles	00	12 ea	1.70/0.34
<b>Iron Handle Brush</b>					
36289	6" Iron Handle Brush with Polypropylene Bristles	Medium Scrubbing/Corner Areas	00	48 ea	18.24/0.70
<b>Hand &amp; Nail Brushes</b>					
36239	3.5" Plastic Block Hand & Nail Brush	Hands & Nails	00	24 ea	1.68/0.09
40020	5" Handle Hand & Nail with Polyester Bristles	Hands & Nails	00	12 ea	4.30/0.27
40021 <b>C</b>	5" Handle Hand & Nail Brush Kit	Hands & Nails	00	12 ea	5.45/0.44
40022	36" Replacement Coiled Vinyl Security Line	—	00	12 ea	0.50/0.17
40023	Replacement Hook only for Hand & Nail Brush Pack	—	00	12 ea	1.00/0.05

Cash 'N Carry products are designated with a **C**





## Clean-Up Brushes

- Non-porous plastic blocks are economical and sanitary
- Plastic blocks will not splinter, crack, or absorb oils and water
- 45463, 45493 have hardwood block design with palmyra bristles



Prod No	Description	Recommended For Cleaning	Color	Pack	Cs Wt/Cube
<b>All Purpose Utility Scrub Brushes</b>					
40541	8" Utility Scrub Brush with Polyester Bristles, 2" trim	Pots/Pan/Medium Scrubbing	02, 03, 04, 05, 09, 14, 24, 68	12 ea	6.80/0.65
40501	20" Utility Scrub Brush with Polyester Bristles, 2" trim	Pots/Pan/Medium Scrubbing	02, 03, 04, 05, 09, 14, 24, 68	12 ea	9.55/1.15
<b>Polypropylene Block Kitchen Brushes</b>					
40545	8" Brush with Medium Stiff Polyester Bristles, 1.6" trim	Pots/Pan/Medium Scrubbing	00	12 ea	6.30/0.65
40546	8" Brush with Medium Stiff Polyester Bristles, 1.6" trim	Pots/Pan/Medium Scrubbing	02	12 ea	8.00/0.65
40542	8" Brush with Medium Stiff Nylon Bristles, 1.4" trim	Pots/Pan/Medium Scrubbing	00	12 ea	8.00/0.65
40500	20" Brush with Medium Stiff Nylon Bristles, 1.6" trim	Pots/Pan/Medium Scrubbing	00	12 ea	8.95/1.17
<b>Ergonomic Hand Scrubs</b>					
36506	8" Utility Scrub with Crimped Polypropylene Bristles, 2" trim	Pots/Pan/Medium Scrubbing	03	12 ea	6.68/0.72
36506L	20" Utility Scrub with Crimped Polypropylene Bristles, 2" trim	Pots/Pan/Medium Scrubbing	03	12 ea	9.19/1.25
<b>Clean-Up Brushes</b>					
365015	6" Brush with Polypropylene Bristles, 1.38" trim	Pots/Pan/Medium Scrubbing	00	12 ea	4.00/0.29
36505	8.5" Brush with Polypropylene Bristles, 2" trim	Pots/Pan/Medium Scrubbing	00, 01, 14	12 ea	5.36/0.74
36505L	20" Brush with Polypropylene Bristles, 2" trim	Pots/Pan/Medium Scrubbing	00, 01, 14	12 ea	10.92/1.35
45463	8.5" Utility Scrub Brush with Stiff Palmyra Bristles	Wok/Gong/Electric Griddles	00	12 ea	7.00/0.70
45493	20" Utility Scrub Brush with Stiff Palmyra Bristles	Wok/Gong/Electric Griddles	00	12 ea	9.30/1.35

## EQUIPMENT BRUSHES

## High Temperature Equipment Brushes

- All of our high temperature brushes have stiff, Teflon® bristles that withstand temperatures up to 500°F
- High temperature brushes save time since equipment can be cleaned while it is still warm
- Plastic handles provide a “cool touch”



## Low Temperature Equipment Brushes

- 40040 and 40042 Tank and Kettle Brushes have bristles on all sides to provide complete cleaning and can be used with a handle to reach the bottom of kettles and tanks
- 40150 Kettle Drain Valve Brush is a perfect solution for cleaning bacteria prone areas of kettles
- 40028 Dishwasher Spray Arm Brushes have long handles to reach spray arms for thorough cleaning
- 40152 Cool Temperature Fryer Brush has the same shape as our High Temp Fryer Brush(40111) but is used in cool cleaning

## Sparta Coffee Service Brushes

- Brushes are designed to clean all glass and Pyrex® pots and dispensers
- 40025 Coffee Decanter Brush is shaped like the inside of the most popular coffee decanters for quick and easy use
- Use 40673 Urn Brush for quick and easy clean-up of glass gauges on coffee urns
- 40154 Creamer and Percolator Brush is designed for cleaning spouts and tubing on percolators, hot beverage servers, and creamers
- 40153 Curved Coffee Maker Brush is a semi-circular wire wound brush that contours to the inside of coffee pots



## Spouts, Pumps & Valves

- Twisted in wire nylon bristles
- 40180 Tee, Fitting, and Valve Brush is perfect for straight pipes, tees, and valves
- 40155 Condiment Dispenser Spout Brush has flexible wire for efficient cleaning of bacteria prone spouts
- 40156 Condiment Dispenser Plunger Brush has rose-bud tip for efficient dispenser cleaning
- 40157 Beer Tap Line Brush for maintaining quality control of beer on tap

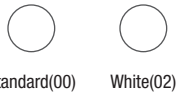

Prod No	Description	Recommended For Cleaning	Color	Pack	Cs Wt/Cube
<b>High Temperature Equipment Brushes</b>					
40110*	28" Straight Utility Brush with 1.38" Teflon Bristles, 1.38" trim	Fryer	00	12 ea	5.90/0.34
40111*	23" L-Tipped Fryer Brush with .88" Teflon Bristles, .88" trim	Fryer	00	12 ea	5.35/0.37
40112*	24" Looped Fryer Basket Brush with 2" Teflon Bristles, 2" trim	Fryer	00	6 ea	3.85/0.34
40114*	3" Wide Brush with Teflon Bristles, .94" - 1" trim	Waffle/Griddles	00	12 ea	2.35/0.16
40115*	1" Round Brush with Teflon Bristles, 2" trim	Waffle/Griddles	00	12 ea	1.85/0.10
40113*	20" Utility Brush with Teflon Bristles, 2" trim	Panini Grills	00	12 ea	11.90/1.06
<b>Low Temperature Equipment Brushes</b>					
40040	Tank & Kettle Brush with Nylon Bristles, 5.25" x 7.5" trim	Kettle & Tank	00	12 ea	10.66/1.06
40042	Tank & Kettle Brush with Nylon Bristles, 5.5" x 9.5" trim	Kettle & Tank	00	12 ea	15.00/1.28
40150	28" Kettle Valve with Stiff Polyester Bristles, 1.38" trim	Kettle Valve	00	12 ea	5.65/0.36
40028	35" Dishwasher Spray Arm with Polyester Bristles, 1" trim	Dishwasher	00	12 ea	6.00/0.55
40152	23" Cool L-Tipped Fryer with Polyester Bristles, .88" trim	Fryer	00	12 ea	5.10/0.34
<b>Sparta Coffee Service Brushes</b>					
40025	16" Coffee Decanter Brush with Soft Polyester Bristles, 4.6" - 6.4" trim	Coffee Decanter	00	6 ea	3.65/1.34
40673	25" Handle Urn Brush with Polyester Bristles, .63" trim	Coffee Urn & Tap	00	12 ea	0.94/0.07
40154	12" Creamer Brush with Polyester Bristles, 1" x 1.5" trim	Coffee Spout	00	24 ea	0.66/0.38
40153	10" Curved Coffee Maker Brush with Soft Polyester Bristles, 1.5" trim	Coffee Maker	00	12 ea	3.00/0.44
<b>Spouts, Pumps &amp; Valve Brushes</b>					
36552	8" Spout Brush	Spouts/Faucets	00	144 ea	4.62/0.32
40157	5.25" Beer Tap with Polyester Bristles, .25" trim	Beer Taps	00	24 ea	0.30/0.05
40180	15" Valve & Fitting with Polyester Bristles, 1" trim	Valves & Fittings	02	12 ea	4.00/0.20
40155	13" Spout Brush with Polyester Bristles, .44" trim	Condiment Pumps	00	12 ea	0.46/0.13
40156	10.5" Plunger Brush with Polyester Bristles, .94" trim	Condiment Pumps	00	12 ea	0.85/0.13

\*Teflon® is a registered trademark of E.I. DuPont® DeNemours & Co., Inc.

## WIRE BRUSHES

### Oven/Broiler Brushes & Scrapers

- Wire bristles and stainless steel metal scrapers make removal of heavy carbon deposits, rust, and burned-on food build-up easy and quick
- Broiler Master features a specially treated wooden head with two-sided stainless (40290) or carbon steel (40026) bristles, a metal end scraper and a 30" handle
- 40294 Double Broiler King features sturdy construction with two heads featuring carbon steel flat bristles on one side and carbon steel wire bristles on the other; bolted together on a heavy hardwood handle for very heavy use
- 40291 Oven Brush features crimped brass wire bristles and a full length stainless steel scraper for cleaning high-temperature stack ovens
- 40293 Pizza Oven Brush has crimped brass wire bristles and a full length aluminum scraper on a low-profile head for cleaning the narrow spaces inside pizza ovens
- 45772 Pizza/BBQ Oven Brush has carbon steel bristles and permanent 30" hardwood handle



40026



40290



40294



41520



40291



40293



45772



363725

Equipment must be turned off prior to using Oven & Grill Brushes



# UNIQUE EQUIPMENT BRUSHES

## Meat Slicer Cleaning Tool

- Helps keep hands and fingers away from slicer blade
- Easy clean-up of slicers without disassembling slicer
- Slicer tool has scraper on one end for scraping hardened foods
- Scrub pad wraps around meat slicer tool for a one-time thorough cleaning



40728

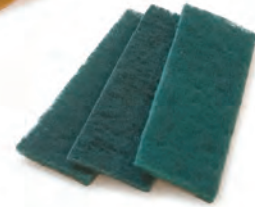

40729

## Hot Dog Roller Brush

- 41169 has special “V” shaped stiff polyester bristle design to clean hot dog rollers and connecting points at the side walls at the same time



41169

## Cutter Brush

- 2.5" long, extra stiff nylon bristles reach through the grid of stainless steel cutters



40529



Standard(00)



Green(08)



Tan(25)

Prod No	Description	Recommended For Cleaning	Color	Pack	Cs Wt/Cube
<b>Oven/Broiler Brushes &amp; Scrapers</b>					
40026	30" Broiler Master with Carbon Steel Bristles	Broiler	00	6 ea	15.35/1.62
40290	30" Broiler Master with Stainless Steel Bristles	Broiler	00	6 ea	15.00/1.62
40294	48" Double Broiler King with Carbon Steel Flat & Wire Bristles	Broiler	00	2 ea	7.00/1.54
41520	42" Oven Brush & Scraper with Brass Wire Bristles (includes Handle)	Oven	00	1 ea	2.60/0.55
40291*	8.5" Oven Brush & Scraper with Brass Wire Bristles (Head only)	Oven	00	12 ea	13.00/0.44
40293*	10" Pizza Oven Brush with Scraper with Brass Wire Bristles (Head only)	Pizza Oven	00	12 ea	10.70/0.22
45772	39" Pizza/BBQ Oven Brush with Carbon Steel Wire Bristles	Pizza/BBQ Oven	00	12 ea	19.00/1.21
363725	Oven & Grill Brush with Scraper & Flat Wire Stainless Steel Bristles	Oven/Grill	00	1 ea	3.00/0.64
<b>Meat Slicer Cleaning Tool</b>					
40728	Meat Slicer Cleaning Tool	Meat Slicer Blade	25	12 ea	3.50/0.23
40729	Meat Slicer Scrub Pad	Meat Slicer Blade	08	12 pk	3.41/1.14
<b>Hot Dog Roller Brush</b>					
41169	24" Hot Dog Roller Brush with Stiff Polyester Bristles	Hot Dog Roller	00	12 ea	6.05/0.34
<b>Cutter Brush</b>					
40529	2.5" Vegetable Cutter Brush with Nylon Bristles, 2" trim	Lettuce & Onion Cutters	00	12 ea	6.00/0.30

\*40291 & 40293 do not include handles; use with handle 40275 shown on page 236

# WIRE BRUSHES & SCRAPERS

## Toothbrush Style Utility Brushes

- Narrow profile cleans tight kitchen spaces and around ceramic tile
- Available in a choice of .5" long stiff nylon bristles for normal cleaning; stainless steel or brass bristles for tougher cleaning jobs



## Grill Bricks, Screens & Polishing Pads

- Apply with cooking oil to protect the grill cure and remove excess cooked-on foods
- 40710 Grill Brick is a fast, efficient, and sanitary way to clean hot or cold grills
- Plastic wrapping on Grill Brick dissolves to eliminate mess
- 40713 Grill Screen and 40711 Grill Polishing Pad attach to the 40712 Grill Pad Holder for a complete grill maintenance system



40710



40712

Equipment must be turned off prior to using Oven & Grill Brushes

40672    40670    40671    45779



45571



## Scratch Brushes

- Compact profile for heavy scraping and cleaning in tight, narrow spaces
- Available with wood handles for cleaning hot grills and ovens
- With carbon steel wire, or stainless steel wire

Equipment must be turned off prior to using Oven & Grill Brushes

## Butcher Block Brushes

- Aggressive tempered steel wire bristles scrape away contaminated layers of wooden butcher blocks and wooden cutting boards

40676

45781



Standard(00)

Prod No	Description	Recommended For Cleaning	Color	Pack	Cs Wt/Cube
<b>Toothbrush Style Utility Brushes</b>					
40674	7" Plastic Handle with .5" Nylon Bristles	Tile/General Purpose	00	12 ea	0.50/0.03
40675	7" Plastic Handle with .5" Stainless Steel Bristles	Ovens/Grills/Small tough areas	00	12 ea	0.55/0.02
41270	7" Plastic Handle with .5" Brass Bristles	Ovens/Grills/Small tough areas	00	12 ea	1.00/0.06
<b>Grill Bricks, Screens &amp; Polishing Pads</b>					
40710	3.5" x 4" x 8" Grill Brick	Grill	00	12 ea	8.00/0.92
40713	4" x 5.5" Grill Screen 20 ea/pack, 10 packs/case	Grill	00	10 pk	3.75/0.13
40711	4" x 5" x .25" Grill Polishing Pads 10 ea/pack, 6 packs/case	Grill	00	6 pk	4.60/0.70
40712	Grill Pad Holder	Grill	00	10 ea	6.00/0.32
<b>Scratch Brushes</b>					
40670	11.5" Plastic Handle with Carbon Steel Bristles	Grills/Ovens	00	12 ea	4.06/0.22
40671	11.5" Plastic Handle Scraper with Carbon Steel Bristles	Grills/Ovens	00	12 ea	4.50/0.22
40672	11.5" Plastic Handle Scraper with Stainless Steel Bristles	Grills/Ovens	00	12 ea	4.60/0.22
45773	14" Wood Handle Scraper with Tempered Steel Bristles	Grills/Ovens	00	12 ea	5.10/0.29
45571	20" Wood Handle Scraper with Carbon Steel Bristles	Hot Grills/Ovens	00	12 ea	10.00/4.14
45779	11" Heavy-Duty Wood Handle Scraper with Tempered Steel Bristles	Hot Grills/Ovens	00	12 ea	7.00/0.34
<b>Butcher Block Brushes</b>					
40676	4" x 9" Brush with Flat Steel Bristles	Butcher Block	00	12 ea	23.75/1.05
45781	2.63" x 7.75" Brush with Steel Bristles	Butcher Block	00	12 ea	10.70/0.35

## TABLETOP & COUNTER CLEANING

### Square Steri- & Suds-Pail®

- 3, 6 and 8 quart Pails meet board of health & HACCP guidelines for dedicated containers
- Use red Steri-Pails for sanitizing solutions, green Suds-Pails for cleaning solutions
- Pails have both standard and metric measurements on the interior walls
- Helper handles for better control
- Instructions for mixing and using sanitizing solutions is printed on the pails in English, Spanish and French
- Made of sturdy, dishwasher safe plastic



11833

11828

11832

36334

### Microfiber

- Carlisle's complete line of Microfiber products can save you significant time, money, and labor compared to traditional cleaning tools
- Unique ultra-fine filament combined with our exclusive polyester/polyamide nylon blend cleans better and last longer than other microfibers
- Cloths remove up to 400% more dirt, dust, and grime with a single pass compared to traditional cleaning products
- Carlisle microfibers can significantly reduce your chemical usage in a broad number of common cleaning tasks because they clean better themselves
- Provides effective cleaning after more than 500 uses (use & launder)
- Long product life could save you as much as 60% per year over the cost of traditional alternatives



### Microfiber Cleaning/Polish Cloths

- Recommended use: Polishing cloth for mirrors, glass and metal; cleaning cloth for dusting counters, walls and equipment
- Use the ultra-fine suede finish polishing keeps surfaces gleaming without sprays and chemicals
- Super-tough terry cleaning cloths work better and last longer than cotton rags
- Microfiber loops hold dirt and grease - won't redeposit
- Rinse clean and dry fast

### Large Sponge

- Natural color, synthetic material



365501



# HAND SQUEEGEES & SCRAPERS

## Hand Held Window Squeegees

- Recommended use: Cleaning windows
- Double blade squeegees use red rubber with a screw-in metal frame
- Single blade squeegees use black rubber in a quick release channel style frame



## Window Scrapers

- Professional 4" wide scraper with plastic handle
- 4" scraper blade has one sharp edge and one dull edge

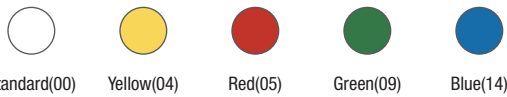

Prod No	Description	Recommended For Cleaning	Color	Pack	Cs Wt/Cube
<b>Square Steri- &amp; Suds-Pail</b>					
11828	3 qt Square Steri-Pail	Hold Sanitizers	05	12 ea	4.48/1.31
11829	6 qt Square Steri-Pail	Hold Sanitizers	05	12 ea	7.25/2.24
11830	8 qt Square Steri-Pail	Hold Sanitizers	05	12 ea	12.63/3.03
11831	3 qt Square Suds-Pail	Hold Cleaning Solutions	09	12 ea	4.48/1.31
11832	6 qt Square Suds-Pail	Hold Cleaning Solutions	09	12 ea	7.25/2.24
11833	8 qt Square Suds-Pail	Hold Cleaning Solutions	09	12 ea	12.63/3.03
<b>Microfiber Cleaning/Polish Cloths</b>					
36333	16" x 16" Microfiber Fine Polishing Cloth 12 per pack/12 packs per case	Mirrors/Glass/Metal	14	12 pks	1.20/0.17
36334	16" x 16" Terry Microfiber Cleaning Cloth	Counters/Walls/Equipment	04, 05, 09, 14	12 ea	1.20/0.17
<b>Large Sponge</b>					
365501	8.25" x 4.25" x 2.25" Large Sponge	Floors/Counters	00	24 ea	1.44/2.15
<b>Hand Held Window Squeegees</b>					
40073	10" Double-Blade with Metal Handle	Windows/Equipment	00	12 ea	9.00/1.06
41027	12" Double-Blade with Metal Handle	Windows	00	12 ea	9.40/0.20
40074	14" Double-Blade with Metal Handle	Windows	00	12 ea	9.55/1.30
40070	12" Single-Blade with Metal Handle	Windows	00	12 ea	9.50/1.07
40071	16" Single-Blade with Metal Handle	Windows	00	12 ea	11.00/1.39
<b>Window Scrapers</b>					
365117	Complete Scraper with 6" Plastic Handle Head & Blade	Tables/Floors/Windows	00	10 ea	3.10/0.26
365120	4" Replacement Blade Dispenser 10 per pack/10 packs per case	—	00	10 pks	2.00/0.89

# DUSTERS

## Counter Top & Radiator Brushes

- Wide variety of bristle and handle choices
- 36211's flagged bristles are ideal for cleaning up fine particles and dust
- 45411 .5" Narrow Profile Radiator Brush cleans counter tops, between equipment and counter tops, and refrigerated cooling coils



## Dusters

- 363404 has soft flagged filament for thorough cleaning
- 45733 and 363156 available with static active 100% lambswool; lambswool is electrostatically charged to attract lint and dust particles
- Telescopic handles for cleaning hard to reach areas



Prod No	Description	Recommended For Cleaning	Color	Pack	Cs Wt/Cube
<b>Counter Top &amp; Radiator Brushes</b>					
40480	8" Plastic Handle with White Polyester Bristles, 2.5" trim	Counters/Tables	01, 02, 04, 05, 09, 14, 24, 68	12 ea	7.66/1.35
40481	8" Plastic Handle with Black Polyester Bristles, 2.5" trim	Counters/Tables	00	12 ea	9.00/1.35
40485	8" Wood Handle with Horsehair & Polypropylene Blend Bristles, 2.5" trim	Counters/Tables	00	12 ea	9.00/1.35
36211	8" Plastic Counter Brush, 2.5" trim	Counters/Tables	23, 24	12 ea	9.00/1.37
45411	24" Radiator Brush with Horsehair-Polypropylene Bristles, 2" trim	Radiators/Narrow Areas	03	12 ea	4.10/0.33
<b>Dusters</b>					
363404	9" Flagged Polypropylene Duster	Walls/Ceilings	14	12 ea	4.92/4.48
365450	34" – 59" Metal Telescopic Handle	Attach to 363404	00	12 ea	6.96/0.24
45733	30" – 42" Telescopic Plastic Handle with Lambswool	Vents/Blinds	00	12 ea	4.00/0.30
363156	52" – 81" Telescopic Poly Wool Duster	Vents/Blinds	00	12 ea	3.96/0.61

## Handle Guide

Prod No	Page	Description	Type of Handle	Recommended Handle
<b>Equipment Brushes</b>				
40040	227	Tank & Kettle Brush	Threaded	40230
40042	227	Tank & Kettle Brush	Threaded	40230
40026	230	30" Broiler Master	Threaded	020-30B
40290	230	30" Broiler Master	Threaded	020-30B
40291	230	8.5" Oven Brush & Scraper	Threaded	40275
40293	230	10" Pizza Oven Brush	Threaded	40275
41520	230	42" Oven Brush & Scraper	Threaded	020-40
<b>Hand Squeegees</b>				
40070	250	12" Single-Blade Squeegee	Tapered	365408
40071	250	16" Single-Blade Squeegee	Tapered	365408
40073	250	10" Double-Blade Squeegee	Tapered	365408
40074	250	14" Double-Blade Squeegee	Tapered	365408
41027	250	12" Double-Blade Squeegee	Tapered	365408



# FLOOR&RESTROOM CARE

Dedicated to floor care and cleanliness, Carlisle is proud to offer a full line of floor care products. From mops to squeegees and even drain openers, we take pride in our ability to offer you only the best in floor care.

<b>Product</b>	<b>Page</b>
Brooms	
Angle Brooms . . . . .	222 & 223
Natural Corn & Blend Brooms . . . . .	.225
Recycled Broom . . . . .	.223
Synthetic Corn Broom . . . . .	.225
Brush Racks . . . . .	236 & 237
Brushes	
Dual Surface Brushes . . . . .	.228
Swivel Floor Brushes . . . . .	.228
Tile & Grout Brushes . . . . .	.229
Dust & Lobby Pans & Combos . . . . .	.224
Dust Mops & Handles . . . . .	238 & 239
Floor & Deck Scrub Brushes . . . . .	.228
Floor Maintenance	
Caution Barriers & Cones . . . . .	.248
Floor Drain Brush & Drain Opener . . . . .	.249
Boot 'N Shoe Brush . . . . .	.250
Wet Floor Signs . . . . .	.248
Floor Squeegees	
Double Foam Squeegees . . . . .	230 & 231
Rubber Squeegees . . . . .	.232
Versa Clean Brush & Squeegees . . . . .	.233

<b>Product</b>	<b>Page</b>
Floor Sweeps	
All Purpose Omni Sweep . . . . .	.226
Fine Floor Sweeps . . . . .	.226
Heavy Floor Sweeps . . . . .	.227
Medium Floor Sweeps . . . . .	.226
Multi-Surface Floor Sweeper . . . . .	.224
Handles . . . . .	234-236
Handle Guide . . . . .	251 & 252
Microfiber System . . . . .	.238
Rectangular Microfiber Bucket . . . . .	.238
Mops, Mop Handles & Accessories	
Cut-End Mops . . . . .	.244
Looped-End Mops . . . . .	241-243
Mop Bucket/Wringer Combos . . . . .	.247
Mop Handles . . . . .	.246
Screw Top Mops . . . . .	.244
Sponge Mops . . . . .	.245
Restroom Maintenance	
Bowl Brushes . . . . .	.250
Ergonomic Force Cup . . . . .	.250
Rotary Brushes . . . . .	.229
Squeegees . . . . .	230-233



# UPRIGHT BROOMS

## Duo-Sweep® Angle Brooms

- Recommended use: General purpose, reaching into corners, along walls and into hard to reach areas
- Excellent balance to reduce sweeping fatigue
- Durable, long-lasting polypropylene bristles
- Standard color (00) angle brooms have two handle holes; one angled, one upright
- Colored angle brooms have one upright hole
- Sparta Spectrum Duo-Sweep's 41082 and 41083 are available in a variety of colors to help facilitate HACCP zone identification



36865



36885

41082



41083



## Duo-Sweep® Brooms

- Recommended use: General purpose, reaching into corners, along walls and into hard to reach areas
- Two handle holes; upright hole for general purpose sweeping or angle hole for reaching into corners, along walls, or into hard to reach areas
- Flagged blue synthetic filament for fine debris; stiff black synthetic filament for heavier sweeping
- Black synthetic filament that can be easily cleaned to extend broom life; guaranteed to outlast up to four corn brooms

36859



36863



36883



36860



36864



36884





### Recycled Angle Broom

- Recommended use: Smooth or rough surface
- Contains 80% recycled flagged PET bristles and 60% recycled polypropylene copolymer shroud for increased stability
- Economical long lasting flagged bristles sweeps up even the smallest particles
- Includes 48" durable vinyl coated metal handle with swivel hanging cap for storage



### Economy Upright Angle Broom

- Recommended use: General purpose sweeping
- Economic, all-purpose 8.75" wide angle broom
- Pivoting hanging hole at top for storage
- 50.5" plastic coated metal handle



Prod No	Description	Trim	Color	Pack	Cs Wt/Cube
<b>Flagged Duo-Sweep Angle Brooms</b>					
36861	6.5" Flagged Duo-Sweep Angle Broom with 30" Metal Handle	5.5" - 7"	00	12 ea	9.00/0.31
36865	12" Flagged Duo-Sweep Medium Duty Angle Broom with 48" Metal Handle	5.5" - 7"	00	12 ea	9.00/5.08
41082	12" Flagged Spectrum Duo-Sweep Broom with 48" Fiberglass Handle	5.5" - 7"	01, 02, 04, 05, 09, 14, 24, 25, 68	12 ea	28.00/4.89
36867	12" Flagged Duo-Sweep Angle Broom (Head Only)	5.5" - 7"	00, 01, 02, 04, 05, 09, 14, 24, 25	12 ea	12.70/1.56
<b>Unflagged Duo-Sweep Angle Brooms</b>					
36885	12" Unflagged Duo-Sweep Heavy Duty Angle Broom with 48" Metal Handle	5.5" - 7"	00	12 ea	21.04/0.31
41083	12" Unflagged Spectrum Duo-Sweep Broom with 48" Fiberglass Handle	5.5" - 7"	01, 02, 04, 05, 09, 14, 24, 68	12 ea	21.34/4.87
36868	12" Unflagged Duo-Sweep 12" Angle Broom (Head Only)	5.5" - 7"	01, 02, 04, 05, 09, 14	12 ea	12.44/1.43
<b>Flagged Duo-Sweep Brooms</b>					
36859	7.5" Flagged Duo-Sweep Lobby Broom with 30" Black Metal Handle	4"	14	12 ea	9.00/1.33
36863	11" Flagged Duo-Sweep Light Industrial Broom with 48" Blue Metal Handle	4"	14	12 ea	15.50/4.63
36883	13" Flagged Duo-Sweep Warehouse Broom with 48" Blue Metal Handle	7"	14	12 ea	17.00/3.92
<b>Unflagged Duo-Sweep Brooms</b>					
36860	7.5" Unflagged Duo-Sweep Lobby Broom with 30" Black Metal Handle	4"	03	12 ea	9.50/1.33
36864	11" Unflagged Duo-Sweep Light Industrial Broom with 48" Blue Metal Handle	4"	03	12 ea	16.00/4.47
36884	13" Unflagged Duo-Sweep Warehouse Broom with 48" Black Metal Handle	7"	03	12 ea	22.50/4.63
<b>Recycled Angle Broom</b>					
40650	12" Flagged Recycled Angle Broom with 48" Steel Handle	6" - 7"	00	12 ea	22.00/5.23
<b>Economy Upright Angle Broom</b>					
367016TC	8.75" Wide Angle Upright Broom	4"	00	12 ea	18.48/1.85

# DUST & LOBBY PANS

## Multi-Surface Floor Sweeper

- Recommended use: In any foodservice establishment
- Brushless mechanical sweeper has non-marking rubber blades that grab fine particles and heavy debris from various types of floor surfaces
- Soft non-marking wheels which glide on carpet, hardwood, vinyl and tile floors
- Sweeper's corner brushes allow the sweeper to pick-up close to baseboards
- Large capacity dust bins thoroughly clean blades as they rotate; won't re-deposit dirt like ordinary sweepers
- Easy one touch doors for emptying debris
- Provides a 7.13" and 10" sweeping path
- Made of durable ABS plastic
- Ergonomic swivel handle is made of galvanized steel



### Cash 'N Carry

Selected products also available in a cash 'n carry pack. See page 286.

## Lobby Pan & Broom Combos

- Recommended use: In any foodservice establishment
- Lobby pans and brooms with sectional handles to give you over 50% reduction in carton size; lower cube saves warehouse space and shipping costs
- The lobby pans pivot and lock into place during use and release for easy carrying or emptying
- Handles feature a pivoting hanging hole at top for storage
- 361415 Combo includes the following:
  - Handy clip to attach broom for convenient storage
  - Serrated edge along the bail allowing you to comb the broom's bristles and drop debris into the pan
  - 30" two-piece handle made from vinyl coated steel
- 361416 Combo includes the following:
  - Slanted edge on pan lays flat on the floor to facilitate easy sweeping
  - Adjustable position head for more functional use in corners and under counters or tables



## Dust & Lobby Pans

- Recommended use: In any foodservice establishment
- Dust Pans are available in metal or plastic as well as in a "flip-up" lobby style or hand held
- Dustpan (361437) features a 90° threaded handle hole to convert it to an economy lobby dustpan



# CORN & UPRIGHT BROOMS



## Natural Corn & Blend Brooms

- Recommended use: Sweeps fine particles indoors and outdoors
- Corn brooms have heavy-duty lacquered wood handles and a high bristle fill count
- 41354 Heavy-duty warehouse broom has metal retaining bands and strong synthetic stitching for long-lasting use
- 41350 Janitor broom has wide fan head for greater reach
- 41349 Housekeeping brooms provide excellent durability at an economical price
- 40634 is made of 100% corn fiber

## Synthetic Corn Broom

- Recommended use: Indoors and outdoors on any type of surface
- Stiff flagged bristles sweep up particles and debris from any type of floor surface
- Metal shroud and band stand give extra support under heavy use
- Heavy-duty lacquered wood handle

Prod No	Description	Color	Pack	Cs Wt/Cube
<b>Multi-Surface Floor Sweeper</b>				
36399 <b>C</b>	9.5" Multi-Surface Sweeper	14	4 ea	10.30/0.91
36400 <b>C</b>	12" Multi-Surface Sweeper	14	4 ea	12.00/1.56
<b>Lobby Pan &amp; Broom Combos</b>				
361415 <b>C</b>	Duo-Pan Lobby Pan & Duo-Sweep Broom Combo	03	1 ea	3.75/0.46
361412 <b>C</b>	Broom Handle Clip for 361415	03	12 ea	5.04/0.16
361416 <b>C</b>	Duo-Pan II Lobby Pan & Broom Combo	03	4 ea	12.00/1.56
<b>Lobby &amp; Dust Pans</b>				
361437	12" Wide Rubberized Plastic Dustpan	03	24 ea	12.96/3.13
36236	12" Metal Dustpan	03	12 ea	14.04/2.08
361410	12" Duo-Pan Plastic Lobby Pan with Metal Handle	03	6 ea	14.50/2.05
36141003-1 <b>C</b>	12" Duo-Pan Plastic Lobby Pan with Metal Handle	03	1 ea	3.02/1.16
40663	12" Wide Steel Lobby Pan with Steel Handle	00	6 ea	26.00/4.29
<b>Natural Corn &amp; Blend Brooms</b>				
41354	56" Heavy-Duty Warehouse Broom 30#, 5-Sew	67	12 ea	36.25/4.76
41350	56" Janitor Broom 29#, 5-Sew	67	12 ea	31.00/3.38
41352	55" Housekeeping Broom 22#, 4-Sew	00	12 ea	24.00/3.76
41349	55" Housekeeping Broom 19#, 3-Sew	67	12 ea	34.00/3.76
3682	40" Lobby Broom 9#, 3-Sew	00	12 ea	9.00/3.96
36633	10" Whisk Broom, 2-Sew	00	12 ea	4.40/0.42
40634	56" Length 100% Corn Janitor Broom 28#, 5-Sew	00	6 ea	15.00/2.57
<b>Synthetic Corn Broom</b>				
45643	48" Synthetic Flagged Corn Broom, #18	04	12 ea	18.86/3.44

Cash 'N Carry products are designated with a **C**

# FLOOR SWEEPS



41881  
41880  
shown with 40225 Handle

## All Purpose Omni Sweep®

- Recommended use: Indoor and outdoor sweeping of all floor types
- Unique Omni Sweep's patent pending design combines the features of fine, medium, and heavy floor sweeps all in one convenient product
- Synthetic bristles have pitched angle for fast, effective sweeping on all types of floor surfaces
- Short, heavy bristles in front easily sweeps up heavy debris Long, fine/medium bristles in back sweep fine dust and particles
- Graduating trim from 1.63" to 2.38"
- Handles not included; see pages 251 & 252 for handle recommendations

## Sweep Complete™ Floor Sweeps

- Recommended use: Indoor and outdoor sweeping of all floor types
- Plastic block with medium and heavy duty 3" PPY trim bristles
- Block has rubber squeegee on one side to help remove liquids without the need for a separate tool
- Includes 60", 3-piece aluminum handle with brace



### Cash 'N Carry

Selected products also available in a cash 'n carry pack. See page 288.



36219618



36204824



40562

## Fine Floor Sweeps

- Recommended use: Flagged bristles for fine powder and dust removal on polished wood, marble, terrazzo, or ceramic tile floors
- Fine floor sweeps use soak proof foam blocks to resist splitting and cracking and are unaffected by moisture
- Handles not included; see pages 251 & 252 for handle recommendations

## Medium Floor Sweeps

- Recommended use: For general sweeping of smooth concrete, unpolished wood, vinyl and tile floors
- Medium floor sweeps use soak proof foam blocks to resist splitting and cracking and are unaffected by moisture
- Black natural tampico bristles have medium stiffness and excellent bristle return
- Black natural horsehair bristles combined with medium stiffness polypropylene provide medium to fine sweeping
- Black polypropylene bristles are extremely durable and maintain shape





36207218



45222  
367624

40621  
367618

### Heavy Floor Sweeps

- Recommended use: For coarse, rough surfaces such as asphalt, textured concrete, textured tiles, or any other uneven flooring surface
- Heavy-duty maroon polypropylene bristles provide aggressive cleaning, maintain shape and are extremely durable
- Heavy floor sweeps use soak proof foam blocks to resist splitting and cracking and are unaffected by moisture
- Handles not included; see pages 251 & 252 for handle recommendations

### Heavy-Duty Floor Sweeps

- Recommended use: For outdoor use on sidewalks, parking lots, entry ways, and storage areas
- Palmyra stalk fiber bristles provide heavy removal of trash and accumulated debris
- Orange polypropylene bristles provide long life without being affected by chemicals and solvents
- Rugged hardwood blocks provide durability for aggressive cleaning
- Handles not included; see pages 251 & 252 for handle recommendations



Black(03)



Blue(14)



Gray(23)



Orange(24)

Prod No	Description	Handle	Color	Pack	Cs Wt/Cube
<b>Omni Sweeps</b>					
41880	18" Omni Sweep Plastic Block, 1.63" - 2.38" trim	Threaded	00	12 ea	21.00/2.14
41881	24" Omni Sweep Plastic Block, 1.63" - 2.38" trim	Threaded	00	12 ea	27.75/2.61
<b>Sweep Complete Floor Sweeps</b>					
36219618 <b>C</b>	18" Sweep Complete Floor Sweep w/Squeegee, 3" trim	—	14	6 ea	17.47/1.95
36219624 <b>C</b>	24" Sweep Complete Floor Sweep w/Squeegee, 3" trim	—	14	6 ea	21.12/2.37
<b>Fine Floor Sweeps</b>					
36204818	18" Foam Block with Gray Polypropylene, 3" trim	Tapered	23	12 ea	23.00/1.95
36204824	24" Foam Block with Gray Polypropylene, 3" trim	Tapered	23	12 ea	26.00/2.46
<b>Medium Floor Sweeps</b>					
40564	18" Foam Block with Black Tampico, 3" trim	Tapered	00	12 ea	25.00/1.17
40565	24" Foam Block with Black Tampico, 3" trim	Tapered	00	12 ea	34.00/2.61
40561	18" Foam Block with Horsehair-Polypropylene Blend, 3" trim	Tapered	00	12 ea	25.00/2.14
40562	24" Foam Block with Horsehair-Polypropylene Blend, 3" trim	Tapered	00	12 ea	31.50/2.61
362208P18	18" Foam Block with Black Polypropylene, 3" trim	Tapered	03	12 ea	23.00/2.02
362208P24	24" Foam Block with Black Polypropylene, 3" trim	Tapered	03	12 ea	27.64/2.56
<b>Heavy Floor Sweeps</b>					
36207218	18" PPY Sweep, Foam Block, 3.25" trim	Tapered	00	12 ea	21.60/2.01
36207224	24" PPY Sweep, Foam Block, 3.25" trim	Tapered	00	12 ea	35.52/2.63
<b>Heavy-Duty Floor Sweeps</b>					
40621	18" Palmyra Sweep with Hardwood Block, 3.5" trim	Threaded/Tapered	00	12 ea	24.00/2.14
45222	24" Palmyra Sweep with Hardwood Block, 3.5" trim	Threaded/Tapered	00	12 ea	43.00/3.63
367618	18" PPY Sweep, Hardwood Block, 3.25" trim	Threaded/Tapered	24	12 ea	20.00/2.27
367624	24" PPY Sweep, Hardwood Block, 3.25" trim	Threaded/Tapered	24	12 ea	29.26/2.46

Cash 'N Carry products are designated with a **C**

# FLOOR & DECK SCRUB BRUSHES

## Floor & Deck Scrub Brushes

- Recommended use: Cleaning kitchen floors and decks
- Provides excellent scrubbing characteristics and easy to use sizes
- Natural hardwood block



## Dual Surface Brushes

- Recommended use: Cleaning under counters, around equipment, and along baseboards
- Floor scrubs are made with three different brush surfaces for cleaning at different angles
- Non-absorbent plastic blocks and synthetic bristles wash easily and prevent gathering of mold and mildew



## Swivel Floor Brushes

- Recommended use: Clean baseboards, walls and around kitchen equipment
- The low profile design of our patented\* Swivel Scrub® Brush allows it to get into places that would be impossible with a normal floor brush
- 40430 All-Around™ Brush has 4" x 9" swivel head with crimped polypropylene bristles
- 36219663 polypropylene-fill scrub comes with 48" handle

\*U.S. Patent No. 4763377

## Tile & Grout Brushes

- Recommended use: Removing stubborn stains from grouted tile
- 365320 has bevel cut stiff crimped nylon bristles and a swivel head for hard to reach areas
- 41323 with molded-in scraper is a dual purpose brush that can be held in your hand or used with a handle in two different positions for effective cleaning
- 41323 has FDA approved block and bristles
- Handles sold separately; see pages 251 & 252 for more handle recommendations



## ROTARY BRUSHES



### Only Carlisle Colortech™ Rotary Brushes Outlast Floor Pads More Than 200 To 1\*

Featuring the Daily Cleaning Rotary Brush — specifically designed for cleaning of all high gloss floor surfaces while still maintaining floor shine. Ask your Carlisle Representative for more information.

#### Rotary Brushes Advantages Over Pads:

- Reduces packaging, storage, waste and lowers labor cost
- Eliminates pad tearing and the need to re-center pads
- Brushes perform well on all types of surfaces including new or old floors with uneven surfaces

\* Based on an independent 2009 University of Illinois Colortech™ Rotary Brush Study – Durability/Sustainability



Prod No	Description	Handle	Color	Pack	Cs Wt/Cube
<b>Floor &amp; Deck Scrub Brushes</b>					
36175	10" Wood Block with Stiff Polypropylene Bristles	Threaded/Tapered	14	12 ea	11.50/0.75
36275	12" Wood Block with Stiff Polypropylene Bristles	Threaded/Tapered	14	12 ea	14.50/0.97
36193	10" Wood Block with Tampico Bristles	Threaded/Tapered	00	12 ea	11.75/0.82
36192	10" Wood Block with Palmyra Bristles	Threaded/Tapered	00	12 ea	12.00/0.87
36292	12" Wood Block with Palmyra Bristles	Threaded/Tapered	00	12 ea	15.00/0.97
<b>Dual Surface Brushes</b>					
40423	10" Hi-Lo Floor Scrub Brush	Threaded	01, 02, 03, 04, 05, 09, 24, 68	12 ea	16.00/1.28
36197	10" Dual Surface Scrub Brush	Threaded	14	12 ea	14.14/1.95
36190	10" Dual Surface Scrub Brush with Squeegee	Threaded	14	12 ea	13.75/1.56
40422	10" Dual Surface Scrub Brush with End Bristles	Threaded	00*, 05, 09, 14	12 ea	16.45/1.34
<b>Swivel Floor Brushes</b>					
365300**	8" Heavy-Duty Daily Swivel Scrub with Nylon Grit Bristles	Threaded	14	12 ea	9.50/0.68
365310**	8" Swivel Scrub with Heavy Nylon Grit Bristles	Threaded	27	12 ea	9.50/0.68
40430	9" All-Around Scrub Brush with Stiff Polypropylene Bristles	Threaded	00*	12 ea	13.00/1.83
36219663	8" Polypropylene-Fill Swivel Scrub with 48" Handle	—	00	4 ea	6.12/1.84
<b>Tile &amp; Grout Brushes</b>					
365320	7.5" Swivel Head Grout Line Brush, Nylon Bristle	Threaded/Tapered	03	12 ea	3.60/0.33
365351	8.5" Grout Brush, Nylon Bristle	—	03	24 ea	2.00/0.26
41323	9" Tile & Grout Brush	Threaded	02, 04, 05, 09, 14	12 ea	7.50/0.44

\*\*U.S. Patent No. 4763377

# FLOOR SQUEEGEES

## Double Foam Squeegees with Metal Frame

- Recommended use: Heavy-duty removal of dirt, liquids and debris on uneven floor surfaces; Anti-flammatory areas
- Rugged black neoprene for heavy-duty removal of dirt, water and debris
- Medium flexibility and non-marking
- Handles sold separately; see pages 251 & 252 for additional handle recommendations



366530



366824

## Double Moss Foam Rubber with Metal Frame

- Recommended use: Removal of dirt, liquids and debris on uneven or smooth floor surfaces; Anti-flammatory areas
- Moss Foam squeegee is designed for uneven, grouted and smooth surface floors
- Red Moss Foam is fat and oil resistant
- Handles sold separately; see pages 251 & 252 for additional handle recommendations

## Double Foam Rubber Squeegee with Plastic Frame

- Recommended use: HACCP establishments; removal of dirt, liquids and debris on uneven or smooth floor surfaces; Anti-flammatory areas
- Hygienic all plastic construction squeegees are easy to sanitize and available in HACCP colors
- All plastic construction will not rust or bend and helps prevent hazard sparks when cleaning-up flammable fluids
- Handles sold separately; see pages 251 & 252 for additional handle recommendations



41568

41567



366922

## Double Moss Foam Rubber Squeegee with Plastic Frame

- Recommended use: Removal of dirt, liquids and debris on uneven or smooth floor surfaces; Anti-flammatory areas
- All plastic construction will not rust or bend and helps prevent hazard sparks when cleaning-up flammable fluids
- Handles sold separately; see pages 251 & 252 for additional handle recommendations



## Double Foam Rubber Squeegee/Brush with Plastic Frame

- Recommended use: Combination of squeegee and scrubbing bristles is perfect for heavy duty floor care
- Handles sold separately; see pages 251 & 252 for additional handle recommendations

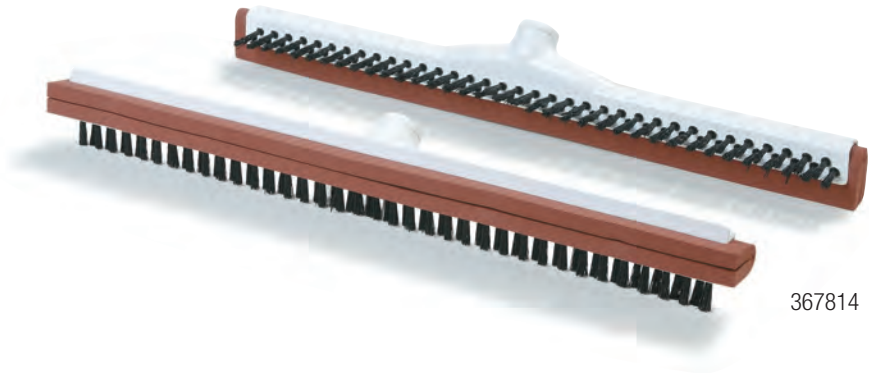

367814



Prod No	Description	Handle Style	Color	Pack	Cs Wt/Cube
<b>Double Foam Squeegees with Metal Frame</b>					
40081	18" Double Foam Neoprene Rubber	1.13" Tapered	00	6 ea	9.20/0.77
40082	24" Double Foam Neoprene Rubber	1.13" Tapered	00	6 ea	14.00/1.00
40083	30" Double Foam Neoprene Rubber	1.13" Tapered	00	6 ea	14.20/1.25
40107	18" Double Foam Neoprene Rubber Refill	—	00	12 ea	1.55/0.20
40108	24" Double Foam Neoprene Rubber Refill	—	00	12 ea	2.01/0.20
40109	30" Double Foam Neoprene Rubber Refill	—	00	12 ea	3.00/0.32
<b>Double Moss Foam Rubber with Metal Frame</b>					
366318	18" Soft Black Foam Rubber	.94" Tapered	00	10 ea	5.80/0.54
366324	22" Soft Black Foam Rubber	.94" Tapered	00	10 ea	8.30/1.03
366824	22" Soft Black Heavy-Duty Foam Rubber	Threaded	00	10 ea	12.00/1.03
366330	30" Reinforced Soft Black Foam Rubber	.94" Tapered	00	10 ea	16.00/1.58
366530	30" Reinforced Red Foam Rubber	.94" Tapered	00	10 ea	16.00/1.58
<b>Double Foam Rubber Squeegee with Plastic Frame</b>					
41567	18" Double Foam Rubber Floor Squeegee	Threaded	02, 04, 05, 09, 14, 24, 68	6 ea	4.40/0.67
41568	24" Double Foam Rubber Floor Squeegee	Threaded	02, 04, 05, 09, 14, 24, 68	6 ea	5.27/0.87
<b>Double Moss Foam Rubber Squeegee with Plastic Frame</b>					
366918	18" Red Foam Rubber	.94" Threaded	00	10 ea	7.50/1.34
366922	22" Red Foam Rubber	.94" Threaded	00	10 ea	10.60/1.97
<b>Double Foam Rubber/Brush with Plastic Frame</b>					
367814	14" Red Double Foam Red Rubber	Threaded	00	10 ea	6.30/1.05
367818	18" Red Double Foam Red Rubber	Threaded	00	10 ea	6.30/1.05

## FLOOR SQUEEGEES (CONT)

### Curved End Rubber Squeegee with Metal Frame

- Recommended use: Allows more control of liquid removal
- Single rubber blade design
- Curved end controls liquid better
- Handles sold separately; see pages 251 & 252 or additional handle recommendations



36324C



40078



40076

### Straight Rubber Squeegee with Metal Frame

- Recommended use: For heavy duty use
- Non-marking single red gum rubber blade with medium flexibility
- Heavy duty steel frame with red powder coating
- Handles sold separately; see pages 251 & 252 for additional handle recommendations

### One-Piece Rubber Squeegee with Plastic Frame

- Recommended use: HACCP establishments, heavy duty use
- Sanitary, solid one-piece construction minimizes contamination areas
- All plastic construction will not rust or bend and helps prevent hazard sparks when cleaning-up flammable fluids
- Integral blade eliminates seams and crevices getting rid of places for bacteria to grow
- Available in eight HACCP colors
- Handles sold separately; see pages 251 & 252 for additional handle recommendations



36568



36567

## VersaClean™ Brush & Squeegee

- Recommended use: For carpets, rugs and uneven bare floors
- Exclusive NSF Listed brush cleans up wet or dry spills
- Scrub heavy tile, grout or even rough concrete surfaces clean
- VersaClean Brushes can be used as an agitator for stubborn spots
- Built-in, one-piece squeegee cleans up wet surfaces quickly
- Unique electrostatic pull-broom action will pick-up light flyaway debris from carpets, rugs, or bare floors
- Made of rubber-like material; resists most chemicals and withstands temperatures up to 212° F



Squeegee cleans up wet surfaces quickly



Picks up light debris from carpet, rugs, or bare floors



Use as an agitator for stubborn spots on tile or concrete



Built-in one-piece squeegee works on rough concrete surface



Standard(00)



White(02)



Black(03)



Yellow(04)



Red(05)



Green(09)



Blue(14)



Orange(24)



Purple(68)

Prod No	Description	Handle Style	Color	Pack	Cs Wt/Cube
<b>Single Curved End Rubber Squeegee with Metal Frame</b>					
36324C	24" Curved End Black Rubber Squeegee	1.13" Tapered	00	6 ea	15.00/0.35
36336C	36" Curved End Black Rubber Squeegee	1.13" Tapered	00	6 ea	22.00/0.37
40078	24" Curved End Red Gum Rubber Squeegee	1.13" Tapered	00	6 ea	15.00/1.00
<b>Single Straight Rubber Squeegee with Metal Frame</b>					
40075	18" Straight Red Gum Squeegee	1.13" Tapered	00	6 ea	10.95/0.77
40076	24" Straight Red Gum Squeegee	1.13" Tapered	00	6 ea	14.15/0.99
40077	36" Straight Red Gum Squeegee	1.13" Tapered	00	6 ea	23.00/1.46
<b>One-Piece Rubber Squeegee with Plastic Frame</b>					
36567	20" Solid, One-Piece Rubber Squeegee	Threaded	02, 03, 04, 05, 09, 14, 24, 68	6 ea	5.50/0.51
36568	24" Solid, One-Piece Rubber Squeegee	Threaded	02, 03, 04, 05, 09, 14, 24, 68	6 ea	6.50/0.61
<b>VersaClean Brush &amp; Squeegee</b>					
36592 Δ	VersaClean Brush with Squeegee	Threaded	03	12 ea	11.00/1.08
36596 Δ	VersaClean Brush with Squeegee	Threaded	03	12 ea	14.00/1.42

NSF Listed products are designated with a Δ

# HANDLES

Carlisle offers a large selection of Flo-Pac® and Sparta® professional quality handles that include fiberglass, plastic, metal, hardwood, telescoping and flo-thru.

## Color-Coded Fiberglass Handles

- Recommended use: During heavy use or in food contact areas
- More sanitary and durable than wood handles
- Self-Locking Flex-Tip Handle (41225, 40225, 40227) offers greater flexibility and reduces handle stress



## Plastic Handles

- Recommended use: In food contact areas
- A variety of sizes with reinforced threaded tip





### 3-Piece Aluminum Handle

- Recommended use: With floor sweeps and in outdoor use
- Utilizes metal y-connectors to secure sections
- Packed in POS packaging for easy display
- Compact size saves on shipping costs



40224

### Telescopic Handles

- Recommended use: For window brushes, squeegees and ceiling dusters
- Adjusts quickly to desired length



365408

41020



Prod No	Description	Handle Dia	Handle Style	Color	Pack	Cs Wt/Cube
<b>Color-Coded Fiberglass Handles</b>						
41225	48" Fiberglass Handle with Self-Locking Flex-Tip	1"	Threaded	00*, 04, 05, 09, 14	12 ea	10.50/0.64
40225	60" Fiberglass Handle with Self-Locking Flex-Tip	1"	Threaded	01, 02, 03, 04, 05, 09, 14, 24, 25, 68	12 ea	13.00/0.80
40227	60" Solid Foam Filled Fiberglass Handle with Self-Locking Flex-Tip	1"	Tapered/Threaded	02, 04, 05, 09, 14	12 ea	16.00/0.80
40220	60" Fiberglass Handle	1"	Tapered/Threaded	01, 02, 04, 05, 09, 14	12 ea	12.00/2.14
40210	60" Economy Fiberglass Handle	.94"	Female Threaded	01, 02, 04, 05, 09, 14	12 ea	10.26/0.89
41020	54" to 8' Threaded Telescoping Fiberglass Handle	1"	Threaded Telescoping	01, 02, 04, 05, 09, 14	12 ea	28.00/1.00
<b>Plastic Handles</b>						
40230	36" Plastic Handle with Reinforced Tip	1"	Threaded	00*	12 ea	17.70/0.55
40233	48" Plastic Handle with Reinforced Tip	1"	Threaded	00*	12 ea	22.00/0.76
40232	60" Plastic Handle with Reinforced Tip	1"	Threaded	00*	12 ea	27.00/0.91
<b>3-Piece Aluminum Handle</b>						
40224	60" 3-Piece Aluminum Handle with Standard Thread	1"	Threaded	00	12 ea	13.00/0.80
<b>Telescopic Handles</b>						
365408	54" to 8' Aluminum Telescopic Handle with Locking Joints	1"	European Tapered/ Standard Threaded	00	10 ea	11.90/0.48
41020	54" to 8' Fiberglass Telescopic Handle	1"	Threaded	01, 02, 04, 05, 09, 14, 25	12 ea	28.00/1.00

# WOOD HANDLES & ACCESSORIES

## Coated Metal Handles

- Recommended use: Alternative to wood handles; Duo-Sweep replacement handle
- Soak proof handles won't crack or splinter
- Plastic hanging cap



## Wood Handles

- Recommended use: Outdoor use and/or as a economical alternative
- Made of lacquered hardwood for consistent dependability

### Metal Threaded Wood Handles

- Metal end increases durability and handle life

### Tapered Wood Handle

- Precision cut tapered end



## Color-Coded Brush Rack

- Recommended use: Storing handles, squeegees and mops
- Heavy gauge aluminum rack promotes fast drying bristles and helps prevent handle breakage and damage to walls and counters
- Extra deep (2.25") frame extends out from wall to allow brushes to hang with bristles facing the wall
- Holds up to 10 drilled handle brushes or other kitchen tools
- Mounting holes are 16" on center, screws for mounting included

### Roll 'N Grip Plus

- Recommended use: Storing handles, squeegees and mops
- Constructed of light-weight, durable ABS and rubber
- Fold-up hanging hooks for smaller items; hold up to 1.5 pounds each
- For use in temperatures from -4°F to 176°F
- Grips accommodate items from .63" - 1.25" in diameter and 0.4 - 8.25 pounds



40737



#### Cash 'N Carry

Selected products also available in a cash 'n carry pack. See page 286.



40731

### Roll 'N Grip™ Broom & Brush Holder System

- Recommended use: Storing handles, squeegees and
- Adjustable rack holds a variety of handle diameters
- Comes with a convenient hook for tools and brushes (additional hooks and grippers are available by special order)
- Rack anchor holes are 16" on center (mounting screws included)



White(00)



Aluminum(00)\*



Black(03)



Yellow(04)



Red(05)



Green(09)



Blue(14)

Prod No	Description	Handle Dia	Handle Style	Color	Pack	Cs Wt/Cube
<b>Coated Metal Handles</b>						
3620194	48" Light Weight Powder Coated Metal Handle with Plastic Tip	.88"	Threaded	14	12 ea	7.85/0.71
3620294	48" Plastic Coated Metal Handle	.94"	Threaded	03	12 ea	8.00/0.46
<b>Wood Threaded Handles</b>						
40271	60" Wood Handle	.94"	Threaded	00	12 ea	13.36/0.49
40267	60" Wood Handle	1.13"	Threaded	00	12 ea	16.00/0.62
<b>Metal Threaded Handles</b>						
40275	40" Metal Tip Wood Handle	.88"	Metal Thread	00	12 ea	9.65/0.40
45267	60" Wood Handle with Metal Tip	.94"	Metal Thread	00	12 ea	13.75/0.49
<b>Tapered Handles</b>						
40261	54" Wood Handle	1.13"	Tapered	00	12 ea	15.00/0.59
40262	60" Wood Handle	1.13"	Tapered	00	12 ea	16.80/0.66
<b>Color-Coded Brush Rack</b>						
40735	17" Brush Rack	—	—	00*, 04, 05, 09, 14	12 ea	3.50/0.77
<b>Roll 'N Grip Plus</b>						
40737 <b>C</b>	Roll 'N Grip Plus Broom & Brush Holder	—	—	00	24 ea	35.00/2.68
<b>Roll 'N Grip Broom &amp; Brush Holder System</b>						
40731	Roll 'N Grip Broom & Brush Holder System	—	—	00	12 ea	9.00/1.06
40732	Roll 'N Grip Holder (2 per pack) with 4 Wood Screws	—	—	00	12 pk	3.35/0.30
40733	Roll 'N Grip Hooks (2 per pack) with 4 Wood Screws	—	—	00	12 pk	0.50/0.16

Cash 'N Carry products are designated with a **C**

# MICROFIBER SYSTEM & DUST MOPS

## Microfiber Dry Mops

- Recommended use: Perfect for healthcare and hospitality
- Traditional looped fringe keeps dust down
- Cut-end with microfiber center clings to dust like a magnet
- Quickly attaches itself to aluminum head
- Machine washable



3633118



3633218

3633519

## Microfiber Wet Mop

- Recommended use: Perfect for healthcare and hospitality
- Dries quicker, cleans more thoroughly than a standard mop
- Looped end microfiber reduces drag on floor
- Machine washable and still effective with over 500 washings
- Quickly attaches itself to aluminum head

## Aluminum Flat Mop Heads & Telescoping Handle For Microfiber

- Recommended use: With Microfiber Dry Mops and Wet Mops

### Mop Heads

- Heavy duty construction and swivel mechanism
- For use with wet and dry microfiber flat mops

### Handle

- 70" telescopic handle for use with Aluminum flat mop heads



3633670

3633519

## Rectangular Microfiber Bucket

- Recommended use: With Microfiber wet mops
- Rectangular bucket with 6 gallon capacity
- Includes snap-on lid and clip-on plastic sleeve for window washers and squeegees
- Molded-in graduations
- Ergonomic handle for easy transportation



3633019



3647524

41672

## Value Line Tie Back Dust Mops & Frames

- Recommended use: For daily sweeping of smooth indoor floors; great for schools, cafeterias, offices, etc.
- An economical choice for a cotton dust mop with full tie back
- Frame is constructed of heavy gauge metal
- Zinc plating reduces rust and corrosion



## Wedge Dust Mop

- Recommended use: For daily sweeping of smooth indoor floors; great for schools, cafeterias, offices, etc.
- Cotton dust mop with frame
- Threaded handle hole
- Handles sold separately; see pages 251 & 252 for additional handle recommendations



## Dust Mop Handles

- Recommended use: With Carlisle dust mops
- 364105 secures quickly to all dust mop frames; one-piece polyurethane connector requires no locking mechanism and provides 360° cleaning
- 362013 and 45850 have clip-on connectors that easily attach to dust mop frame; handle and frame combination give 360° cleaning



Standard(00)

Red(05)

Green(09)

Blue(14)

Gray(23)

Prod No	Description	Handle Dia	Handle Style	Color	Pack	Cs Wt/Cube
<b>Microfiber Dry Mops</b>						
3633118	18" Microfiber Dry Mop Pad	—	—	14	12 ea	3.10/0.41
3633124	24" Microfiber Dry Mop Pad	—	—	14	12 ea	4.25/0.80
3633136	36" Microfiber Dry Mop Pad	—	—	14	12 ea	6.55/0.90
<b>Microfiber Wet Mops</b>						
3633218	18" Microfiber Wet Mop Pad	—	—	05, 09, 14	12 ea	2.10/0.21
3633224	24" Microfiber Wet Mop Pad	—	—	14	12 ea	2.80/0.33
<b>Aluminum Flat Mop Heads</b>						
3633519	18" Aluminum Flat Mop Head	—	3633670	00	12 ea	8.60/0.98
3633525	24" Aluminum Flat Mop Head	—	3633670	00	12 ea	10.90/1.25
3633537	36" Aluminum Flat Mop Head	—	3633670	00	12 ea	13.30/1.92
<b>Telescoping Handle</b>						
3633670	70" Aluminum Telescopic Handle	—	—	00	12 ea	3.70/1.20
<b>Rectangular Microfiber Bucket</b>						
3633019	6 gal Rectangular Microfiber Bucket	—	—	23	3 ea	12.50/1.15
<b>Value Line Tie Back Dust Mops</b>						
3647524	24" Dust Mop, Fits 5" Wide Frame	—	—	00	12 ea	15.96/1.08
3647536	36" Dust Mop, Fits 5" Wide Frame	—	—	00	12 ea	18.96/1.42
3647548	48" Dust Mop, Fits 5" Wide Frame	—	—	00	12 ea	24.96/1.83
<b>Wedge Dust Mop</b>						
36490	Wedge Dust Mop	—	Threaded	00	12 ea	7.20/1.07
36490R	Wedge Mop Replacement	—	Threaded	00	12 ea	5.04/1.07
<b>Dust Mop Frames</b>						
41672	24" Mop Frame, 5" Wide	—	Clip-On/Flexible	00	12 ea	12.75/0.42
41673	36" Mop Frame, 5" Wide	—	Clip-On/Flexible	00	12 ea	17.00/0.62
3647248	48" Mop Frame, 5" Wide	—	Clip-On/Flexible	00	12 ea	24.00/1.01
<b>Dust Mop Handles</b>						
364105	60" Vinyl Coated Metal Dust Mop Handle with Flexible Connector	.94"	—	00	12 ea	15.00/2.10
45850	60" Wood Dust Mop Handle with Clip-On Connector	.94"	—	00	12 ea	20.00/1.63
362013	60" Vinyl Coated Metal Dust Mop Handle with Clip-On Connector	.94"	—	00	12 ea	20.10/2.54

# WET MOP BASICS

Use the guide below to help choose the right products for your floor care needs.



## BANDSTYLES



### Wide Band

Vinyl coated mesh. 5" Width



### Narrow Band

Textured polyester tape. 1.25" Width



### Screw Top

Textured polyester tape with a metal screw on attachment. 1.25" Width

## YARN

- It is important to choose the right mop in order to get maximum efficiency
- Some yarns naturally perform specific cleaning tasks better than others

Yarn	Advantages	Disadvantages	Use
<b>Cotton</b>	Good absorption & retention with limited shrinkage & a low initial cost.	Break-in period required. Slow drying yarn leads to mildew & deterioration. Lints.	Designed for general use. Scrubbing & cleaning up liquids.
<b>Synthetic</b>	Long stable fiber offers excellent tensile strength without linting.	Higher cost. Poor absorption.	Rough surfaces.
<b>Cotton/Synthetic Blend</b>	Excellent choice for performance, price & durability. Synthetic fiber offers durability & color options.	Possible shrinkage.	Requested by professionals who require a better, longer lasting mop.
<b>Rayon</b>	Absorbs quickly with easy release. Dries fast & is mildew resistant. Cleaner yarn with less linting.	Shrinks when laundered and has less liquid retention.	Use for applying liquids such as disinfectant or floor finishes.

## Yarn Ply

- The term yarn ply = number of strands twisted together to make a single yarn strand
- Although more plies give added strength, it does not always mean higher quality yarn
- More strands can add durability, but they decrease absorbency
- It is better & more cost effective to choose a higher quality yarn than a high ply, low quality yarn

## Twist

- The "twist" of a yarn is a result of how tightly the fiber strands are wound together
- A tightly twisted yarn might have more strength & last longer, but it can have less absorbency
- The best choice is determined by the type & quality of the yarn, as well as the mop's construction
- Mops with looped-end construction allow the yarn to have a loose twist without the fraying

## CUT-END VS LOOPED-END MOPS

### Cut-End

- Cut-end mops are the most popular
- Low purchase price & perceived as economical
- Cannot be laundered & must be purchased more often, making the ultimate cost higher
- Cover less area per pass when mopping
- Cut end mops fray & unravel with use & have a tendency to leave behind loose strands & lint

### Looped-End

- Outlast cut-end mops 8 to 1
- Superior performance & last longer than cut-end style mops
- Launderable
- Their tailband style gives better mopping coverage
- The looped-ends prevent fraying & unraveling so you can enjoy reduced labor costs & lower replacement cost
- Although the initial cost may be more expensive than a cut-end style, the life expectancy makes looped-end mops a more economical choice

# MOPPING SOLUTIONS

## Synthetic/Cotton Blend Looped End Mops

- Mops are not pre-shrunk
- Brick Pack reduces cube up to 62%
- Handles sold separately

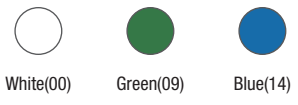

Prod No	Description	Handle Style	Yarn Color	Pack	Cs Wt/Cube
<b>Premium Band Looped End Mops</b>					
369412B	Small Yellow Wide Band Mop with White Yarn	Jaw Style	00	12 ea	8.00/0.68
369442B	Small Yellow Wide Band Mop with Blue Yarn	Jaw Style	14	12 ea	8.00/0.68
369472B	Small Yellow Wide Band Mop with Green Yarn	Jaw Style	09	12 ea	8.00/0.68
369418B	Medium Green Wide Band Mop with White Yarn	Jaw Style	00	12 ea	12.50/0.68
369448B	Medium Green Wide Band Mop with Blue Yarn	Jaw Style	14	12 ea	12.50/0.68
369478B	Medium Green Wide Band Mop with Green Yarn	Jaw Style	09	12 ea	12.50/0.74
369424B	Large Red Wide Band Mop with White Yarn	Jaw Style	00	12 ea	17.20/0.74
369454B	Large Red Wide Band Mop with Blue Yarn	Jaw Style	14	12 ea	17.20/0.74
369484B	Large Red Wide Band Mop with Green Yarn	Jaw Style	09	12 ea	17.20/0.74
369430	X-Large Blue Wide Band Mop with White Yarn	Jaw Style	00	12 ea	23.04/2.71
369460	X-Large Blue Wide Band Mop with Blue Yarn	Jaw Style	14	12 ea	23.04/2.92





# MOPPING SOLUTIONS (CONT)

## Recycled Blue Jean Looped-End Mop

- A green alternative for mopping
- Cotton/synthetic blend of recycled knits and reconditioned denim
- Handles sold separately; see pages 251 & 252 for additional handle recommendations



360714B

## Cotton Looped-End Mops

- 4-ply looped-end cotton
- Brick pack reduces cube up to 62%
- Mops are not pre-shrunk
- Handles sold separately; see pages 251 & 252 for additional handle recommendations

## Narrow Band Mops



369413B



369419B

369419B Brick Pack

## Wide Band Mops



369550B



369552B



### Bamboo Looped-End Mop

- A green alternative for mopping, utilizes rapidly renewable bamboo silk
- Bamboo silk material provides excellent durability



### Microfiber Looped-End Mop

- Microfiber mop combines the absorbency and durability of microfiber with conventional mop design and functionality
- Washable mop dries quickly and is still effective with 500 washings
- See page 238 for a complete list of microfiber products



### Rayon Blend Looped-End Finishing Mops

- Durable 4-ply rayon blend has narrow band
- Releases liquid faster than a conventional mop for a smoother finish



White(00)



White(02)



Blue(14)

Prod No	Description	Handle Style	Yarn Color	Pack	Cs Wt/Cube
<b>Recycled Blue Jean – Wide Band Mop Head</b>					
360714B	Recycled Blue Jean Red Band Looped End Mop	Jaw Style	14	12 ea	18.00/0.74
<b>4 Ply Cotton – Narrow Band Mop Heads</b>					
369413B	Small Yellow Band Looped-End Mop	Quick Release/Quick Change	00	12 ea	8.10/0.68
369419B	Medium Green Band Looped-End Mop	Quick Release/Quick Change	00	12 ea	12.60/0.68
369425B	Large Red Band Looped-End Mop	Quick Release/Quick Change	00	12 ea	17.80/0.74
<b>4-Ply Cotton – Wide Band Mop Heads</b>					
369550B	Small Yellow Band Looped-End Mop	Jaw Style	00	12 ea	8.00/0.68
369551B	Medium Green Band Looped-End Mop	Jaw Style	00	12 ea	12.50/0.68
369552B	Large Red Band Looped-End Mop	Jaw Style	00	12 ea	17.20/0.74
<b>Bamboo – Wide Band Mop Head</b>					
369520	Medium Loop End Bamboo Silk Mop	Jaw Style	02	12 ea	14.00/1.33
<b>Microfiber – Wide Band Mop Head</b>					
369420	Medium Loop End Microfiber Mop	Jaw Style	02, 14	12 ea	14.00/1.33
<b>4-Ply Rayon Blend – Wide Band Mop Head</b>					
369670B	#20 Medium Finishing Looped-End Mop	Quick Release/Quick Change	14	12 ea	14.00/0.68
369674B	#24 Large Finishing Looped-End Mop	Quick Release/Quick Change	14	12 ea	17.20/0.74

# MOPPING SOLUTIONS (CONT)

## Cut-End Mops

- Comes in brick pack reducing the cube up to 62% and saving you shelf space
- Handles sold separately; see pages 251 & 252 for additional handle recommendations

### 8-Ply Cotton – Narrow Band



369724

### 4-Ply Cotton – Narrow Band



369824B

### 4-Ply Cotton – Wide Band



369817B

369819B

### 4-Ply Rayon – Narrow Band



369074B

## Kwik-On™ Screw Top Mops

- Easy to change cut-end mop heads lie flat for more efficient mopping
- Available in 4-ply cotton or rayon
- 40345 Kwik-On wood handle (sold separately) attaches securely to Kwik-On mop head with a counter-sunk, reinforced thread with zinc-plated handle connection



369032C



40345

369024C

### Automatic Sponge Mop

- Recommended use: Mopping smooth surface floors
- Synthetic sponge head absorbs liquid fast

### Ty-Dee™ Sponge Mop

- Recommended use: Mopping smooth surface floors
- Cellulose sponge head with non-corrosive metal parts and enameled wood handle

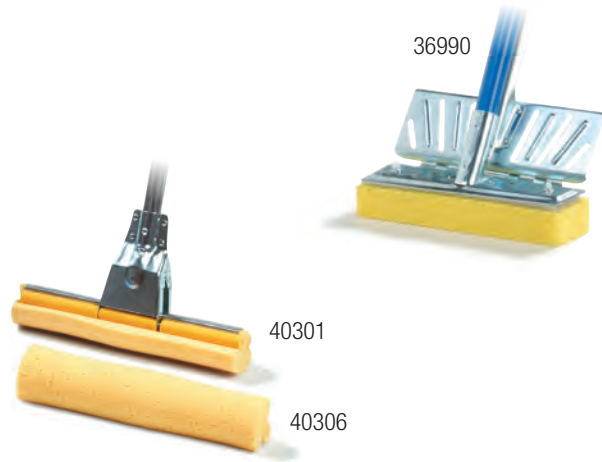

Standard(00)

Prod No	Description	Handle Style	Color	Pack	Cs Wt/Cube
<b>8-Ply Cotton – Narrow Band Mop Heads</b>					
369724	#24 Select Cut End Mop	Quick Release/Quick Change	00	12 ea	18.96/1.81
369732	#32 Select Cut End Mop	Quick Release/Quick Change	00	12 ea	26.04/1.96
<b>4-Ply Cotton – Narrow Band Mop Heads</b>					
369816B	#16 Small Cut End Mop	Quick Release/Quick Change	00	12 ea	10.25/0.68
369820B	#20 Medium Cut End Mop	Quick Release/Quick Change	00	12 ea	13.25/0.68
369824B	#24 Large Cut End Mop	Quick Release/Quick Change	00	12 ea	16.25/0.68
369832	#32 X-Large Cut End Mop	Quick Release/Quick Change	00	12 ea	20.52/1.66
<b>4-Ply Cotton – Wide Band Mop Heads</b>					
369811B	#16 Small Cut End Mop	Jaw Style	00	12 ea	9.50/0.68
369814B	#20 Medium Cut End Mop	Jaw Style	00	12 ea	10.25/0.68
369817B	#24 Large Cut End Mop	Jaw Style	00	12 ea	14.00/0.68
369819B	#32 X-Large Cut End Mop	Jaw Style	00	12 ea	15.50/0.68
<b>4-Ply Rayon – Narrow Band Mop Head</b>					
369066B	#16 Small Cut End Mop	Quick Release/Quick Change	00	12 ea	8.00/0.68
369070B	#20 Medium Cut End Mop	Quick Release/Quick Change	00	12 ea	13.25/0.68
369074B	#24 Large Cut End Mop	Quick Release/Quick Change	00	12 ea	16.45/0.74
369082	#32 X-Large Cut End Mop	Quick Release/Quick Change	00	12 ea	20.52/1.58
<b>4-Ply Cotton – Kwik-On Screw Top Mop</b>					
369016C	#16 Kwik-On Mop Head	40345	00	12 ea	12.96/1.26
369024C	#24 Kwik-On Mop Head	40345	00	12 ea	18.96/1.50
369032C	#32 Kwik-On Mop Head	40345	00	12 ea	22.56/2.90
<b>4-Ply Rayon – Kwik-On Screw Top Mops</b>					
369016R	#16 Kwik-On Rayon Mop Head	40345	00	12 ea	12.96/0.93
369024R	#24 Kwik-On Rayon Mop Head	40345	00	12 ea	18.96/1.26
<b>Kwik-On Handle</b>					
40345	60" Kwik-On Handle – 1.13" D	—	00	12 ea	16.70/0.54
<b>Automatic Sponge Mops – Aluminum Handle</b>					
40300	8.5" Automatic Sponge Mop	—	00	12 ea	23.80/5.78
40301	12" Automatic Sponge Mop	—	00	6 ea	13.85/7.23
40305	8.5" Automatic Sponge Mop Refill	—	00	12 ea	3.85/0.44
40306	12" Automatic Sponge Mop Refill	—	00	6 ea	2.75/2.21
<b>Ty-Dee Sponge Mop – Enamel Wood Handle</b>					
36990	8.25" Ty-Dee Sponge Mop with Built-in Wringer	—	00	12 ea	18.96/4.04
36990R	8.25" Ty-Dee Refill	—	00	12 ea	3.96/0.35

# MOP HANDLES & MOP BUCKETS

## Jaw Style Mop Handles

- Recommended use: Use with wide band mop heads

369475

36970



41664



369595

## Quick-Release Mop Handles

- Recommended use: With Narrow Band Mops
- Flexible plastic head with hinged gripper bites into any size mop band
- Releases mop head quickly; employees never need to touch a dirty mop head

## Quick Change Handles

- Recommended use: With Narrow Band Mops
- Plastic head reduces spread of bacteria and won't rust or corrode
- Metal heads feature standard wing nut construction with a quick release cross bar

369365

369375



40340

36968

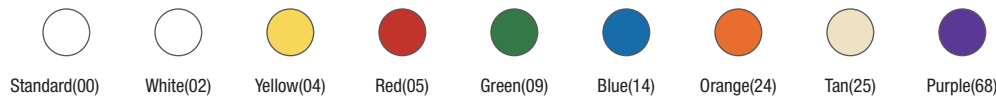

Prod No	Description	Handle Dia	Color	Pack	Cs Wt/Cube
<b>Jaw Style Mop Handles</b>					
369475	60" Fiberglass Mop Handle	1"	00	12 ea	25.00/3.46
36970	60" Vinyl Coated Metal Mop Handle	.94"	00	12 ea	13.92/2.27
<b>Color-Coded Quik-Release Mop Handle</b>					
41664	60" Fiberglass Mop Handle	1"	02, 04, 05, 09, 14, 24, 25, 68	12 ea	15.75/2.78
<b>Quik-Release Handle</b>					
369595	Quik-Release Powder-Coated Metal Handle	—	00	12 ea	17.60/2.68
<b>Quick Change Handles – Wood</b>					
369365	60" Wood Mop Handle with Plastic Head	1.13"	00	12 ea	22.50/3.46
40340	63" Wood Mop Handle with Metal Head	1.13"	00	12 ea	30.00/2.00
<b>Quick Change Handle – Fiberglass</b>					
369375	60" Fiberglass Mop Handle with Plastic Head	1"	00	12 ea	16.25/3.46
<b>Quick Change Handle – Vinyl Coated Metal</b>					
36968	60" Handle with Plastic Head	1"	00	12 ea	15.36/2.27



### Double Bucket Mopping Systems

- Recommended use: For mopping heavy traffic areas with a lot of dirt
- Utilizes indexed, bucket-within-bucket design to separate dirty from clean water
- Dividing water reduces weight when emptying and makes it easier to set up for replenishing cleaning solutions
- Divided buckets minimizes contamination of cleaning solution by dirty water
- 36906DW's wide platform base adds extra stability to minimize spills in high traffic areas



#### Cash 'N Carry

Selected products also available in a cash 'n carry pack. See page 287.

### Mop Bucket/Wringer Combos

- Recommended use: Daily mopping
- Made of durable, corrosion resistant polyethylene
- Non-marking casters
- Available in 26 or 35 quart sizes
- 36908 is excellent for use in space constrained environments where larger mop buckets are not feasible
- Individual Side Press Wringer available – fits both 26 quart (36908) and 35 quart (36904) mop buckets



Standard(00)

Yellow(04)

Red(05)

Green(09)

Blue(14)

Brown(69)

Prod No	Description	Color	Pack	Cs Wt/Cube
<b>Double Bucket Mopping Systems</b>				
36906D <b>C</b>	35 qt Double Bucket Combo with Side Press Wringer	04	1 ea	22.92/6.37
36906DW <b>C</b>	35 qt Double Bucket Combo with Side Press Wringer	04	1 ea	34.17/8.89
<b>Mop Buckets</b>				
36908 <b>C</b>	26 qt Bucket with Side Press Wringer	04, 05, 09, 14, 69	1 ea	15.40/3.01
36904 <b>C</b>	35 qt Bucket with Side Press Wringer	04, 05, 09, 14, 69	1 ea	19.10/3.15
36908W	Side Press Wringer for 26 qt and 35 qt Mop Bucket	04, 05, 09, 14, 69	1 ea	8.00/1.62
36905	35 qt Bucket with Down Press Wringer	04	1 ea	22.20/3.32
36908C	3" Swivel Casters for all Mop Buckets	00	2 ea	8.00/2.88

Cash 'N Carry products are designated with a **C**

# FLOOR & RESTROOM MAINTENANCE

## Wet Floor Signs

- Two-sided sign is 25" x 11"
- Specially designed feet minimize contact with floor to protect floor finishes
- 36900 and 36903 lock into place to prevent collapsing



36941



36940



The Flashing Hazard Light (36949) and Caution Top Card (36947) can be inserted in Caution Cones (36940, 36941) for increased visibility.



36900



36909

## Freestanding Caution Cones and Accessories

- 360° visibility
- Caution message appears in English, Spanish and French

## Caution Pop Up Cones

- 360° visibility
- Caution message appears in English, Spanish and French



Case for 36942 Pop Up Caution Cone



36942



36943

## Caution Barrier

- Two-sided barriers
- Caution message appears in English, Spanish and French

36944



### Drain Opener

- Recommended use: For cleaning all sizes of floor drains
- Convenient, sanitary way to remove floor drain covers
- Easy to use, simply insert into drain and twist to remove drain cover and drain basket
- One-piece construction with plastic handles for secure grip



40146



40144

### Floor Drain Brush

- Recommended use: For cleaning drains in the kitchens, coolers and rest rooms
- Drain Brush handles (sold separately) are prominently marked in English and Spanish for "floor drain use only" to prevent contact with food and serving utensils
- Long lasting polypropylene bristles and plastic handles stand up to rugged use



Standard(00)

White(02)

Yellow(04)

Orange(24)

Prod No	Description	Color	Pack	Cs Wt/Cube
<b>Folding Wet Floor Signs</b>				
36900*	Floor Sign (English/Spanish)	00	6 ea	11.25/1.88
36903	Floor Sign (English/Spanish/German)	00	6 ea	11.25/1.88
36909	Economy Wet Floor Sign (English/Spanish/German)	04	6 ea	12.60/1.45
<b>Caution Cones &amp; Barriers</b>				
36940	27" Caution Cone	04	3 ea	22.00/3.70
36941	36" Caution Cone	04	3 ea	22.00/4.75
36942	20" Pop Up Caution Cone	04	12 ea	57.00/2.18
36943	Folding Geodesic Caution Cone	24	12 ea	15.98/3.70
36949	Caution Cone Flashing Hazard	04	12 ea	7.37/1.30
36947	Caution Cone Top Card	04	12 ea	11.00/1.59
36944	Three Panel Caution Barrier	04	1 ea	9.47/2.53
36945	One Panel Caution Barrier Add On	04	1 ea	4.62/2.53
<b>Drain Opener</b>				
40144	Drain Opener	02	12 ea	6.50/0.78
<b>Floor Drain Brush</b>				
40146	3" Floor Drain Brush	00	6 ea	4.00/0.31
40147	4" Floor Drain Brush	00	6 ea	6.00/0.44
41093	5" Floor Drain Brush	00	6 ea	3.25/0.77
40148	6" Floor Drain Brush	00	6 ea	3.55/1.07
40236	36" Plastic Drain Brush Handle	00	12 ea	18.00/0.55
40237	48" Plastic Drain Brush Handle	00	12 ea	22.00/0.76

# FLOOR & RESTROOM MAINTENANCE (CONT)

## Bowl Brushes

- Recommended use: For cleaning toilet bowls
- Bowl brushes are available in a variety of styles and bristle materials
- 40140 has 180° bristle head to prevent splash-back
- 36232 and 36233 have all-natural cotton yarn securely attached to smooth wood handle

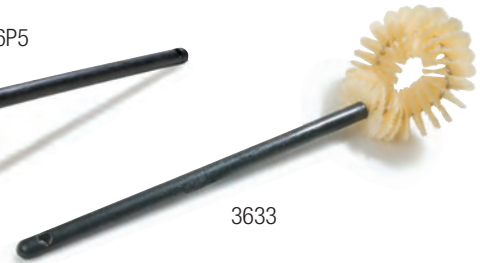

## Ergonomic Force Cup

- Recommended use: For unclogging sinks, floor drains and toilet bowls
- Ergonomic design maximizes applied force while maintaining ease and longevity of use
- Overmolded rubber handle for easy grip
- 21" plastic handle is non-absorbent and more sanitary than wood handles



## Boot 'N Shoe Brush

- Recommended use: Place by kitchen exit
- Helps eliminate dirt, and other contaminants from being tracked into food prep and serving areas
- Chromed steel tube frame can be bolted to floor for security; brushes flip up to expose a steel scraper
- Non-absorbent foam block construction with long lasting blue polypropylene bristles



Prod No	Description	Handle Material	Color	Pack	Cs Wt/Cube
<b>Bowl Brushes</b>					
40140	17" No-Splash Polyester Brush	Plastic	00	12 ea	7.00/1.28
36P5	17" Twist-In-Wire Synthetic Bristle Brush	Plastic	02	24 ea	7.50/2.08
3633	21" Twist-In-Wire Synthetic Bristle Brush	Plastic	00	24 ea	8.82/2.31
36232	10" Cotton Bowl Mop	Wood	00	36 ea	3.60/1.15
36233	20" Cotton Bowl Mop	Wood	00	36 ea	11.88/1.28
<b>Ergonomic Power Plunger</b>					
36439	Ergonomic Power Plunger	Plastic/Rubber	03	12 ea	6.68/0.72
<b>Boot 'N Shoe Brush</b>					
40424	Boot 'N Shoe Brush	—	01, 03, 14	1 ea	5.60/1.22
40425	Boot 'N Shoe Brush Replacement	—	01, 03, 14	12 ea	17.00/1.33



# HANDLE GUIDE

Prod No	Page	Description	Type of Handle	Recommended Handle
<b>Duo-Sweep Brooms</b>				
36859	223	7" Duo-Sweep Flagged Broom	Threaded	362019414
36863	223	9" Duo-Sweep Flagged Broom	Threaded	362019414
36883	223	11" Duo-Sweep Flagged Broom	Threaded	362019414
36860	223	7" Duo-Sweep Unflagged Broom	Threaded	362029403
36864	223	9" Duo-Sweep Unflagged Broom	Threaded	362029403
36884	223	11" Duo-Sweep Unflagged Broom	Threaded	362029403
<b>Sweeps</b>				
41880	227	18" Omni Sweep	Threaded	40225
41881	227	24" Omni Sweep	Threaded	40225
36204818	227	18" Foam Block Fine Sweep	Threaded	40225
36204824	227	24" Foam Block Fine Sweep	Threaded	40225
40564	227	18" Foam Block Medium Sweep	Threaded	40225
40565	227	24" Foam Block Medium Sweep	Threaded	40225
40561	227	18" Foam Block Medium Sweep	Threaded	40225
40562	227	24" Foam Block Medium Sweep	Threaded	40225
362208P18	227	18" Foam Block Medium Sweep	Threaded	40225
362208P24	227	24" Foam Block Medium Sweep	Threaded	40225
36207218	227	18" Foam Block Heavy Sweep	Threaded	40225
36207224	227	24" Foam Block Heavy Sweep	Threaded	40225
40621	227	18" Palmyra Heavy-Duty Sweep	Threaded/Tapered	40225
45222	227	24" Palmyra Heavy-Duty Sweep	Threaded/Tapered	40225
367618	227	18" Heavy-Duty Sweep	Threaded/Tapered	40267
367624	227	24" Heavy-Duty Sweep	Threaded/Tapered	40267
<b>Floor &amp; Deck Scrubs</b>				
36175	229	10" Wood Block Sweep	Tapered	40261
36275	229	12" Wood Block Sweep	Tapered	40261
36193	229	10" Wood Block Scrub	Threaded/Tapered	40225
36192	229	10" Wood Block Sweep	Threaded/Tapered	40225
36292	229	12" Wood Block Scrub	Threaded/Tapered	40225
40423	229	10" Hi-Lo Floor Scrub Brush	Threaded	40225
36197	229	10" Dual Surface Scrub Brush	Threaded	40225
36190	229	10" Dual Action Scrub Brush	Threaded	40225
40422	229	10" Dual Action Scrub Brush	Threaded	40225
365300	229	8" Swivel Scrub	Threaded	40225
365310	229	8" Swivel Scrub	Threaded	40225
40430	229	9" Floor Scrub Brush	Threaded	40225
365320	229	Swivel Head Grout Brush	Threaded	40225
41323	229	9" Tile & Grout Brush	Threaded	40225

Handle Guide is continued on page 252

## HANDLE GUIDE (CONT)

Prod No	Page	Description	Type of Handle	Recommended Handle
<b>Floor Squeegees</b>				
40081	231	18" Straight Steel Squeegee	Tapered	40261
40082	231	24" Straight Steel Squeegee	Tapered	40261
40083	231	30" Straight Steel Squeegee	Tapered	40261
366318	231	18" Straight Squeegee	Tapered	40261
366324	231	22" Foam Squeegee	Tapered	40261
366330	231	30" Soft Black Foam Rubber	Tapered	40261
366530	231	30" Red Foam Rubber Squeegee	Tapered	40261
366824	231	22" Foam Squeegee Threaded Socket	Threaded	40267
41567	231	18" Plastic Squeegee	Threaded	40225
41568	231	24" Plastic Squeegee	Threaded	40225
367814	231	14" Rubber Squeegee with Bristles	Threaded	40210
367818	231	18" Rubber Squeegee with Bristles	Threaded	40210
40075	233	18" Straight Steel Squeegee	Tapered	40261
40076	233	24" Straight Steel Squeegee	Tapered	40261
40077	233	36" Straight Steel Squeegee	Tapered	40261
36567	233	20" Rubber Squeegee	Threaded	40225
36568	233	24" Rubber Squeegee	Threaded	40225
<b>Misc Floor Care</b>				
40146	249	3" Floor Drain Brush	Threaded (Female)	40236
40147	249	4" Floor Drain Brush	Threaded (Female)	40237
41093	249	5" Floor Drain Brush	Threaded (Female)	40237
40148	249	6" Floor Drain Brush	Threaded (Female)	40238



# TRANSPORTATION

Carlisle is an industry leader in designing high-quality dollies, carts, caddies, and trolleys to safely hold and transport food. Our transportation products are built for durability and functionality while incorporating exclusive features that facilitate efficient transport and serving.

<b>Product</b>	<b>Page</b>
Adjustable Handle Trolley . . . . .	.257
Bussing Carts . . . . .	.255
Fold 'N Go Carts . . . . .	.254
Janitorial Carts & Accessories. . . . .	.260
Optimizer Adjustable Dish Dolly Guide . . . . .	.259
Optimizer Adjustable Dish Dollies . . . . .	.258

<b>Product</b>	<b>Page</b>
Service Cart. . . . .	.256
Stainless Steel Utility Carts . . . . .	.256
Standard Platform Truck . . . . .	.257
Tool Caddy. . . . .	.260
Utility Carts . . . . .	256 & 257

# TRANSPORTATION

## Fold 'N Go® Carts

- Folds and unfolds in a single, quick and easy motion
- Each cart holds up to 350 lbs (approximately 116 lbs per shelf)
- Collapses to 9" width and 10.5" width; stores easily behind doors, in between counters, or back of delivery vans
- All bolts are lock-tight secured to remain tight even after extended use
- Sturdy polyethylene shelves are easy to clean; top shelf has ergonomically shaped easy grip handles at both ends for a fast, secure grip
- SBC1521 shelf measure 20.5" L x 15" W; SBC2031 shelf measures 31.5" L x 18.5" W; with 11.5" shelf spacing
- 4" heavy duty non-marking swivel casters with molded-in metal reinforcement plates are permanently staked to .75" solid aluminum legs for longer life and added strength and rigidity
- Cart ships fully assembled; no tools or complicated latches required
- Replacement parts are listed on page 303



SBC1521

SBC2031



Easily folds with one hand

Licensed Product under U.S. Patent No. 5806864



## Bussing Carts

- Durable construction stands up to the toughest use
- Shelves are textured to minimize scratches and provide a better grip
- Convenient knockdown design is easy to assemble
- Available with optional back panels to hide clutter or locking doors to secure sensitive items like liquor or cleaning supplies (15" x 21" size only)
- Replacement parts are listed on page 303



CC2036DP, available with locking doors and side panels to secure sensitive items



### Cash 'N Carry

Selected products also available in a cash 'n carry pack. See page 288.



Standard(00)

Black(03)

Gray(23)

Tan(25)

Trash container and silverware holder available separately

Raised edges on shelves help keep contents secure during transport



Side panels help hide clutter

Durable construction will stand up to the toughest use

Prod No	Description	Weight Capacity	Color	Pack	Cs Wt/Cube
<b>Fold 'N Go Carts</b>					
SBC1521	15" x 21" Fold 'N Go Cart	350 lb	03, 23, 25	1 ea	45.45/6.89
SBC2031	20" x 31" Fold 'N Go Cart	350 lb	03, 23, 25	1 ea	51.00/10.60
SBCC240	Fold 'N Go Cart Replacement Caster, Swivel	—	00	1 ea	2.15/0.12
SBCC245	Fold 'N Go Cart Replacement Caster, Swivel with Brake	—	00	1 ea	2.15/0.12
<b>Bussing Carts</b>					
CC2243 <b>Δ C</b>	42" x 23" Large Bussing Cart	300 lb	03	1 ea	69.00/9.89
CC2036 <b>Δ C</b>	18" x 36" Bussing Cart	300 lb	03	1 ea	43.82/7.58
CC2036DP	18" x 36" Bussing Cart with Doors and Back Panels	300 lb	03	1 ea	51.75/11.59
CC2036P	18" x 36" Bussing Cart with Back Panels	300 lb	03	1 set	48.95/9.90
CD2036	18" x 36" Doors and Back Panels Only	—	03	1 set	7.93/1.93
CP2036	18" x 36" Back Panels Only	—	03	1 set	5.20/1.13
CC11SH	Accessory Bin for Bussing Cart	—	03	1 ea	5.16/1.26
CC11TH	Trash Bin for Bussing Cart	—	03	1 ea	9.23/3.18

NSF Listed products are designated with a **Δ**

Cash 'N Carry products are designated with a **C**

Shipping Notes: CC2036 & SBC1521 can ship UPS/FedEx Ground at oversize cost, CC2243 & SBC2031 cannot ship UPS/FedEx Ground

# CARTS

## Service Cart

- One-piece design, all plastic construction
- Polyethylene exterior and polyurethane foam core for added strength
- Heavy-duty 5" non-marking caster with molded-in metal reinforcement plates
- Optional Trash Container (SBC11TC) and Part Holder (SBC11SH) available separately
- Replacement parts are listed on page 303
- NSF Listed



SBC230 with SBC11TC and SBC11SH

## Stainless Steel Utility Carts

- Utility carts are constructed of heavy gauge stainless steel for superior strength and durability
- Easy to clean tig welded construction provides added durability as compared to other, spot welded utility carts
- Non-marking soft rubber bumpers prevent scratches and scuffs on walls



UC4031529



UC3031524



UC7022133



Black(03)

Prod No	Description	Weight Capacity	Color	Pack	Cs Wt/Cube
<b>Service Cart</b>					
SBC230 $\Delta$ <b>C</b>	Service Cart - 2 Fixed Casters, 2 Swivel Casters, 1 with Brake	500 lb	03	1 ea	57.00/14.29
SBC11SH	Part Holder for SBC230	—	03	1 ea	3.50/0.89
SBC11TC	Trash Container for SBC230	—	03	1 ea	9.15/2.17
<b>Stainless Steel Utility Carts</b>					
UC3031524	15.5" x 24", 3 Shelf Utility Cart	300 lb	—	1 ea	37.00/13.70
UC3031827	18" x 27", 3 Shelf Utility Cart	300 lb	—	1 ea	43.00/13.70
UC5031524	15.5" x 24", 3 Shelf Utility Cart	500 lb	—	1 ea	43.00/13.70
UC5031827	18" x 27", 3 Shelf Utility Cart	500 lb	—	1 ea	52.00/15.51
UC5032135	21" x 35", 3 Shelf Utility Cart	500 lb	—	1 ea	70.00/23.54
UC7031524	15.5" x 24", 3 Shelf Utility Cart	700 lb	—	1 ea	75.00/13.70
UC7031827	18" x 27", 3 Shelf Utility Cart	700 lb	—	1 ea	86.00/15.51
UC7022133	21" x 33", 2 Shelf Utility Cart	700 lb	—	1 ea	94.00/23.54
UC7032133	21" x 33", 3 Shelf Utility Cart	700 lb	—	1 ea	109.00/23.54
UC4031529	15.75" x 29.5", 3 Shelf Knock-Down Utility Cart	400 lb	—	1 ea	31.00/2.50
UC4031733	17.75" x 33.38", 3 Shelf Knock-Down Utility Cart	400 lb	—	1 ea	33.00/3.20

NSF Listed products are designated with a  $\Delta$

Cash 'N Carry products are designated with a **C**

Shipping Notes: SBC230, UC3031524, UC3031827, UC5031524, UC5031827, UC5032135, UC7031524, UC7031827, UC7022133, UC7032133 cannot ship UPS/FedEx

### Utility Carts

- Excellent for transporting equipment and heavy loads
- Bin top utility carts (UC4018 & UC4525) reduce the potential for items to fall off during transport
- Durable and chemical-resistant polypropylene construction; will not rust, dent, chip or peel
- Convenient knock-down design
- Integrated cord wrap for easy access (UC1940)



UC4018



UC1940



### Cash 'N Carry

Selected products also available in a cash 'n carry pack. See page 288.

### Standard Platform Truck

- 36" x 24" durable platform truck for easy transport of large loads
- Heavy-duty 6" casters (2 locking, 2 swivel)



PT4824



Black(03)



Gray(23)

### Adjustable Handle Trolley

- 32" x 20" trolley easily transports large loads
- Multi-position handle adjusts to optimize mobility
- Folds flat for easy storage; great for packing in a delivery van for off-site functions
- Heavy-duty 5" casters (2 fixed, 2 swivel)



HT3220 Cart folds flat for easy storage and packing

HT3220



Prod No	Description	Weight Capacity	Color	Pack	Cs Wt/Cube
<b>Utility Carts</b>					
UC1940 <b>C</b>	19" x 40" x 32.5" Utility Cart	500 lb	23	1 ea	45.05/5.29
UC4018	40" x 17.25" Small Bin Top Utility Cart	500 lb	23	1 ea	35.27/3.31
UC4525	45" x 25" Large Bin Top Utility Cart	500 lb	23	1 ea	41.45/5.82
<b>Standard Platform Truck</b>					
PT4824	36" x 24" Standard Platform Truck	1,000 lb	03	1 ea	34.17/4.88
<b>Adjustable Hand Trolley</b>					
HT3220	32" x 20" Standard Duty Adjustable Handle Trolley	500 lb	03	1 ea	34.00/2.09

Cash 'N Carry products are designated with a **C**

# DISH DOLLIES



ADD4

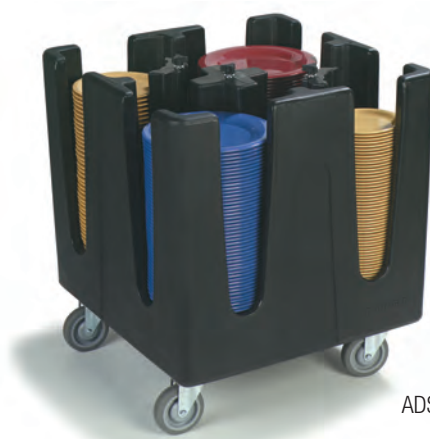

ADS4

## Optimizer™ Adjustable Dish Dollies

- Adjustable dividers eliminate the need for individually sized dollies
- Dollies hold plates from 5.5" to 12.5"
- Polyethylene dividers and walls help prevent dish edge chipping
- Two-handed access to all plates reduces breakage
- Non-marking casters (2 locking, 2 non-locking) for easy transport of loaded dollies
- Includes vinyl cover with easy-opening hook & loop side included for sanitary storage
- Replacement parts are listed on page 303
- NSF Listed

### ADD4, ADD6 Optimizer Dollies Also Feature:

- Most flexible dolly available; holds trays, plates, and platters
- ADD6 holds oval platters from 9.5" x 7.25" to 13.5" x 10.5"
- Holds 5 stacks of 9.88" to 11.25" plates; 25% more than any other similar dish dolly
- Holds 8 stacks of 5.5" to 8.25" plates; 33-50% more than any other similar dish dolly (up to 50 or more plates per stack, depending on plate profile)
- Use 2 to 4 dividers for 10" or larger plates; 6 dividers for 8" to 9.75" plates; 8 dividers for 8 stacks of 7.75" or smaller plates
- 2 dividers for 13.5" x 10.5" platters; 6 dividers for 9.5" x 7.25" to 12" x 9.25" platters.

### ADS4, ADS8 Optimizer Dollies Also Feature:

- Smaller size fits through narrow corridors or under tables
- Flexible configuration holds a variety of plates and platters



Brown(01)



Black(03)



Clear(07)



ADDC Vinyl Cover with ADD6

**WARNING:** Products identified on this page with the following symbol ▼ contain chemicals, including one or more phthalates, known to the State of California to cause cancer and birth defects and other reproductive harm.

Prod No	Description	Color	Pack	Cs Wt/Cube
<b>Optimizer Standard Dish Dollies &amp; Accessories</b>				
ADD4 Δ	Optimizer Dish Dolly with 4 Dividers	01, 03	1 ea	93.00/23.84
ADD6 Δ	Optimizer Dish Dolly with 6 Dividers	01, 03	1 ea	96.20/23.84
ADDD Δ	Optimizer Replacement Dividers (Set of 2)	01, 03	2 ea	4.70/0.47
ADDC ▼	Optimizer Vinyl Replacement Cover (for ADD4 or ADD6)	07	1 ea	2.10/0.31
ADDR	Divider Replacement Hardware (Rod, Washers, Knob)	03	4 ea	0.10/0.04
<b>Optimizer Small Dish Dollies &amp; Accessories</b>				
ADS4 Δ	Optimizer Small Dish Dolly and 4 Adjustable Dividers	03	1 ea	65.00/16.87
ADS8 Δ	Optimizer Small Dish Dolly and 8 Adjustable Dividers	03	1 ea	70.00/20.14
ADSD	Optimizer Replacement Dividers (Set of 4)	03	1 ea	10.00/1.01
ADSC ▼	Optimizer Vinyl Replacement Cover (for ADS4 or ADS8)	07	1 ea	2.10/0.31

NSF Listed products are designated with a Δ

Note: ADD4, ADD6, ADS4, ADS8 cannot ship UPS/FedEx



# Optimizer Adjustable Dish Dolly Guide

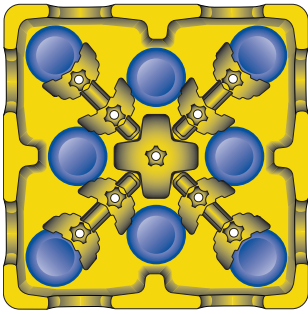

ADS8 Layout for 5.5" plates

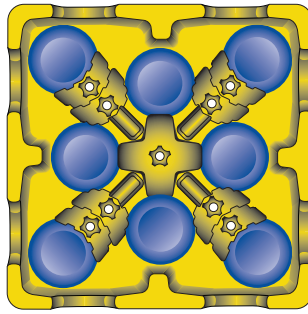

ADS8 Layout for 6.5" plates

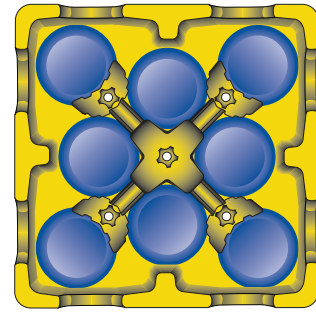

ADS4 Layout for 7.5" plates

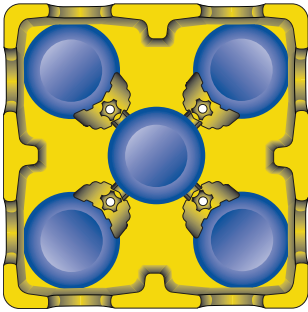

ADS4 Layout for 9" plates

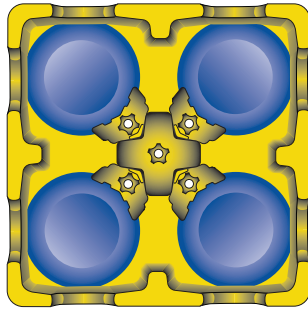

ADS4 Layout for 11" plates

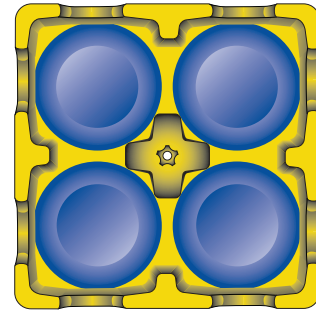

ADS4 Layout for 12" plates

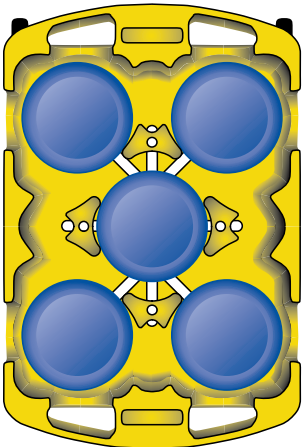

ADD4 Layout for 9.88" to 11.25" plates

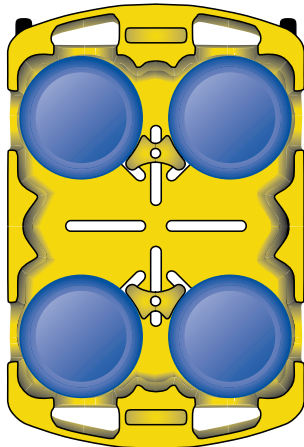

ADD4 Layout for 11.38" to 12.5" plates and 13.5" by 10.5" platters

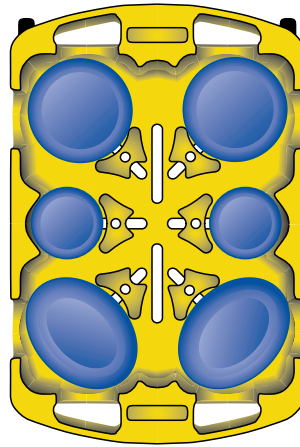

ADD6 Layout for 12" by 9" to 9.5" by 7.25" platters, 5.5" to 8" plates and 5.5" to 12" plates

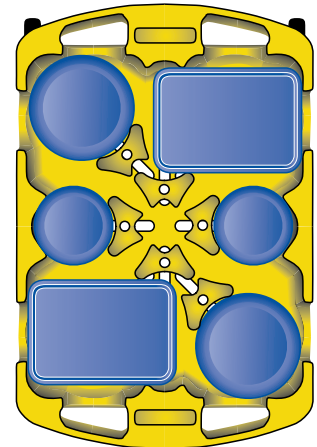

ADD6 Layout for 10" by 14.5" trays and 7.5" plates and 10" plates

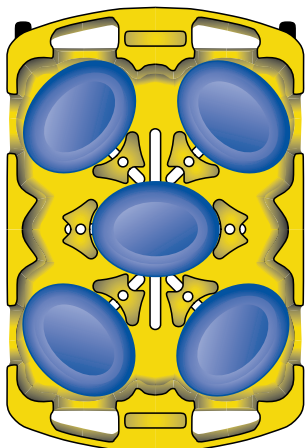

ADD6 Layout for 12" by 9.25" to 9.5" by 7.25" platters

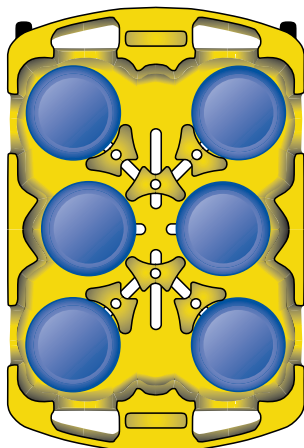

ADD6 Layout for 8.38" to 9.75" plates

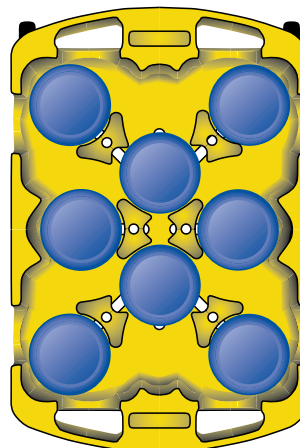

ADD6 Layout for 8" to 8.25" plates

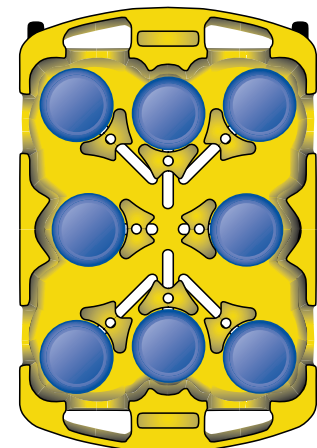

ADD6 Layout with 2 Additional Dividers for 5.5" to 7.88" plates

# JANITORIAL CARTS

## Janitorial Carts & Accessories

- Rugged polypropylene resists cracking, peeling and corrosion
- Three durable shelves with raised edges keep items organized
- Platform base holds a Bucket/Wringer or 23 gallon TrimLine™ Waste Container
- Includes a 25 gallon nylon bag for waste or laundry collection
- 3" standard Carlisle non-marking swivel casters in front; large 8" non-marking rear wheels



Integrated tool holders, shelves, and hooks keep everything organized including unwieldy handles.



Front hooks hold most standard Wet Floor Signs. Built-in hanger holds multiple spray bottles.



Structurally reinforced base and heavy-duty casters/wheels withstand rough use – holds up to 300 lbs.



Tough 25 gallon nylon bag easily attaches to cart arm. Hooks on top of arm to hold trash liners in place. Arm swings up for more compact storage when not in use.



JC1945S



### Cash 'N Carry

Selected products also available in a cash 'n carry pack. See page 288.

## Tool Caddy

- Handled caddy fits in the top compartment of the JC1945 cart series
- Deep compartments prevent spills
- Made of durable polypropylene

JC1945CB



Standard(00)



Blue(14)



Gray(23)

Prod No	Description	Weight Capacity	Color	Pack	Cs Wt/Cube
<b>Janitorial Carts &amp; Accessories</b>					
JC1945S <b>C</b>	45"L x 19"W x 39"H Short Platform Janitorial Cart	300 lb	23	1 ea	33.00/4.45
JC1945L <b>C</b>	49"L x 19"W x 39"H Long Platform Janitorial Cart	300 lb	23	1 ea	41.00/4.49
JC1946	Replacement Bag for JC1945S & JC1945L	—	14	1 ea	1.14/0.06
JC1945CB	Tool Caddy for Janitorial Cart	—	23	1 ea	8.25/1.52
36908C	3" Replacement Casters	—	00	2 ea	8.0/2.88

Cash 'N Carry products are designated with a **C**



# WASTEMANAGEMENT

Carlisle's line of waste management products offers rugged construction. Designed for a range of needs including food storage for items that are NSF Std.2 listed as well as our TrimLine containers for smaller areas, Carlisle is able to meet all your waste management needs.

<b>Product</b>	<b>Page</b>
56 Gallon Container . . . . .	.265
Bronco Waste Containers & Lids . . . . .	.262
Carlisle Dollies . . . . .	262 & 264
Centurian Waste Containers . . . . .	.266
Compost Containers . . . . .	.270
Fire Resistant Wastebaskets . . . . .	.269
Hot Stamped Bronco Containers . . . . .	.262
Office Wastebaskets . . . . .	.269

<b>Product</b>	<b>Page</b>
Recycle Containers & Lids . . . . .	270 & 271
Recycle Lable Kit . . . . .	.271
Roll-Away Container . . . . .	.265
Square Bronco Waste Containers & Lids . . . . .	.264
Step-On Containers . . . . .	.268
Tilt Trucks . . . . .	.272
Tool Caddy Bag . . . . .	.263
TrimLine Waste Containers . . . . .	.267



## WASTE MANAGEMENT

**Bronco™ Waste Containers & Lids**

- Heavy-duty construction with double-reinforced stress ribs; drag skirts for durability
- Comfort Curve™ handles provide easy handling
- Helper handles on base for controlled tipping or overhead lifting
- Reinforced lids have snap down tab locks with a simple press & pull release system for easy removal
- NSF Std 21 - meets the criteria for Thermoplastic Refuse Containers
- NSF Std 2 - meets the criteria for food contact and cleanability

**Hot Stamped Bronco™ Containers**

- Carlisle offers several standard Hot Stamped containers for waste management, visit [carlislefsp.com/custom-imprinting](http://carlislefsp.com/custom-imprinting)
- Custom hot stamping is also available; see page 297 for more information



341010ICE



341034

341057



36911



36910

**Carlisle Dollies**

- Dollies fit our 20, 32, 44, and 55 gallon containers for safe transport of heavy loads
- Simple twist-to-lock feature securely attaches dolly to containers
- Dollies include standard Carlisle non-marking 3" swivel casters
- NSF Std 2 - meets the criteria for food contact and cleanability



341045



341144



## Tool Caddy Bag

- Economical, adjustable caddy bag can hold an assortment of cleaning tools
- Turns a 32 or 44 gallon Bronco into a portable and durable cleaning system platform

36917



### Cash 'N Carry

Selected products also available in a cash 'n carry pack. See page 288.



Recycling options shown on page 270



White(02)



Black(03)



Yellow(04)



Red(05)



Green(09)



Blue(14)



Gray(23)



Orange(24)

Prod No	Description	Color	Pack	Cs Wt/Cube
<b>Bronco Round Waste Containers &amp; Lids</b>				
341010 Δ	10 gal Waste Container, 16.13" x 17"	02, 04, 05, 09, 14, 23, 24	6 ea	16.50/5.45
341011 Δ C	10 gal Lid, 16.13" x 2"	02, 04, 05, 09, 14, 23, 24	6 ea	5.50/0.77
341020 Δ	20 gal Waste Container, 20" x 23"	02, 04, 05, 09, 14, 23, 24	6 ea	34.80/10.97
341021 Δ C	20 gal Lid, 20" x 2.13"	02, 04, 05, 09, 14, 23, 24	6 ea	7.65/4.57
341032 Δ	32 gal Waste Container, 22.38" x 27.75"	02, 04, 05, 09, 14, 23, 24	4 ea	34.40/13.18
341033 Δ C	32 gal Lid, 24" x 2.13"	02, 04, 05, 09, 14, 23, 24	4 ea	7.65/2.47
341034	32 gal Dome Lid	03	1 ea	9.20/4.01
341035	32 gal Funnel Lid	03	4 ea	2.42/1.46
341044 Δ	44 gal Waste Container, 26.88" x 31.38"	02, 04, 05, 09, 14, 23, 24	3 ea	38.40/10.24
341045 Δ C	44 gal Lid 26.88" x 2.25"	02, 04, 05, 09, 14, 23, 24	3 ea	8.70/2.06
341057	44/55 gal Dome Lid	03	1 ea	12.40/6.68
341055 Δ	55 gal Waste Container, 26.5" x 33"	02, 04, 05, 09, 14, 23	2 ea	53.80/26.23
341056 Δ C	55 gal Lid, 26.5" x 2.25"	02, 04, 05, 09, 14, 23	2 ea	7.65/3.20
341057	44/55 gal Dome Lid	03	1 ea	12.40/6.68
341132 Δ	32 gal Container with Dolly, 22.38" x 38.25"	02, 04, 05, 09, 14, 23	4 ea	66.40/17.04
341144 Δ	44 gal Container with Dolly, 26.88" x 37.75"	02, 04, 05, 09, 14, 23	3 ea	57.90/20.41
<b>Hot Stamped Bronco Container</b>				
341010ICE Δ	10 gal "Ice Only" Container	02	6 ea	16.50/5.45
<b>Carlisle Dollies</b>				
36911 Δ	Standard Round Container Dolly, 17.75" x 6"	03	2 ea	10.00/1.30
36910 Δ	Round Container Dolly with Replaceable Casters	03	2 ea	13.00/1.69
3672231	3" Replacement Caster for 36910 Dolly	—	1 ea	1.00/0.01
<b>Tool Caddy Bag</b>				
36917	Tool Caddy Bag for 32 & 44 gal Bronco Waste Containers	04	12 ea	14.74/1.78

NSF Listed products are designated with a Δ

Cash 'N Carry products are designated with a C

# WASTE CONTAINERS (CONT)

## Square Bronco™ Waste Containers & Lids

- Heavy-duty construction with double-reinforced stress ribs; drag skids for durability
- Comfort Curve™ handles provide easy handling
- Helper handles on base for controlled tipping or overhead lifting
- Reinforced lids have snap down tab locks with a simple press & pull release system for easy removal
- NSF Std 2 - meets the criteria for food contact and cleanability



Prod No	Description	Color	Pack	Cs Wt/Cube
<b>Square Bronco Waste Containers &amp; Lids</b>				
341528 Δ	28 gal Square Bronco Waste Container	02, 23	6 ea	8.76/0.16
341529 Δ	Square Bronco Lid for 341528	02, 23	6 ea	2.34/0.17
341540 Δ	40 gal Square Bronco Waste Container	02, 23	4 ea	12.65/0.25
341541 Δ	Square Bronco Lid for 341540	02, 23	4 ea	3.10/0.02
341542 Δ	Dolly for 28/40 gal Square Bronco Container	03	2 ea	4.84/0.03
<b>Roll-Away Container</b>				
345050 Δ	50 gal Rolling Container, 21" x 21" x 38.25"	14, 23	2 ea	42.80/16.48
<b>56 Gallon Container</b>				
344056	56 gal Waste Container	06, 69	1 ea	16.50/11.68
344057	Hooded Top Without Doors for 344056	05, 69	1 ea	7.90/5.14
344058*	Hooded Top With Doors for 344056	05, 69	1 ea	7.90/5.14
344042	Rigid 42 gal Liner for 344056	03	4 ea	9.64/6.89

NSF Listed products are designated with a Δ

\*344058 not compatible with 56 gal Waste Container (344056) when used with the Rigid 42 gal Liner (344042)

## Roll-Away Container

- Same sturdy construction as our Bronco Containers
- Super heavy-duty axle and oversize traction wheels make hauling heavy loads easy
- Unique handle design gives positive grip even when wet
- Deep-pocket foot tilt for simple maneuverability
- Sturdy hinged lid flips open 270° for access – snaps shut tight
- Custom hot stamping is also available; see page 297 for more information
- NSF Std 21 - meets the criteria for Thermoplastic Refuse Containers
- NSF Std 2 - meets the criteria for food contact and cleanability



345050



## 56 Gallon Container

- Rugged construction and pleasing aesthetics for high volume applications both indoor and outdoor
- Integrated bag stays and venting channels allow for easy bag retention and removal
- Can be used in conjunction with two 23 gallon TrimLine™ Containers for further separation of debris
- Hooded top with large openings allows for easy insertion of rubbish while sheltering contents from weather
- Optional rigid liner available

344056



344058



344042



Recycling  
options  
shown on  
page 270

# WASTE CONTAINERS (CONT)

## Centurian™ Waste Containers

- Attractive styling with a functional design that reduces bag vacuum issues allowing for easier liner removal
- Integrated liner tabs prevents liners from slipping into the container
- Ergonomic handles and bottom helper handles make lifting and dumping easier

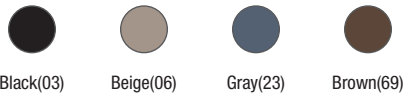

Prod No	Description	Color	Pack	Cs Wt/Cube
<b>Centurian Waste Containers</b>				
343021	21 gal Half Round Centurian Container	06, 23	4 ea	6.51/3.99
343022	Half Round Centurian Lid for 343021	03, 06, 23	4 ea	9.20/3.44
343122	22 gal Tall Round Centurian Container	23	4 ea	6.35/4.35
343123	Swing Top Centurian Lid for 343122	23	4 ea	8.00/2.09
343124	Funnel Top Centurian Lid for 343122	23	4 ea	5.29/1.62
343523	23 gal Tall Square Centurian Container	06, 23, 69	4 ea	6.70/3.82
343525	Swing Top Centurian Lid for 343523	03, 06, 23, 69	4 ea	9.50/2.50
343935	35 gal Centurian Square Waste Receptacle	06, 23	4 ea	7.35/6.62
343950	50 gal Centurian Square Waste Receptacle	06, 23	4 ea	9.00/8.19
343951	Large Centurian Lid for 343935, 343950	06, 23	4 ea	26.40/4.23



### TrimLine™ Waste Containers

- Corner tabs help keep trash bags secure
- Bottom helper handle makes lifting and dumping easier
- Optional swing lid conceals trash while providing easy touch-free access
- Handled lid also available for transport and odor control
- Lids fit both 15 and 23 gallon size containers
- Optional Wire Dolly fits on either narrow or wide side of 23 gallon size container; 100 lb weight capacity
- Custom hot stamping is also available; see page 297 for more information



Corner Tab



342015



Helper Handle

**Up To 40% Easier Liner Removal**  
Ergonomic design reduces vacuum allowing liners to be removed up to 40% easier than the top competitor



342024

342025

342023





342015



342023

36920-1

-   
Black(03)
-   
Beige(06)
-   
Green(09)
-   
Blue(14)
-   
Gray(23)
-   
Brown(69)

 **Recycling options shown on page 270**

Prod No	Description	Color	Pack	Cs Wt/Cube
<b>TrimLine Containers</b>				
342015	15 gal TrimLine Container	06, 23	4 ea	5.70/3.16
342023	23 gal TrimLine Container	03, 06, 09, 14, 23, 69	4 ea	29.60/5.91
342024	TrimLine Swing Top Lid, 20.13" x 11.5" x 4.5"	03, 06, 23, 69	4 ea	10.88/2.36
342025	TrimLine Handled Lid, 20.5" x 11.5" x 3"	03, 09, 14	4 ea	7.76/0.90
36920-1	Wire Frame Dolly for 23 gal TrimLine Container	03	1 ea	12.50/2.37

## WASTE CONTAINERS (CONT)

### Step-On Containers

- Sturdy construction stands up to heavy use while maintaining appearance
- Hands-free design minimizes contact with food or paper waste and the easy-access foot pedal holds up to extensive use
- Color-coded lids are useful when needing to designate recycling, biohazard or other segregated work zones
- Constructed of non-metallic polypropylene, containers are chemical-resistant and corrosion-proof
- Step-on cans assist in complying with OSHA regulation 29CFR 1910.1030 "Occupational and Bloodborne Pathogens"

OSHA

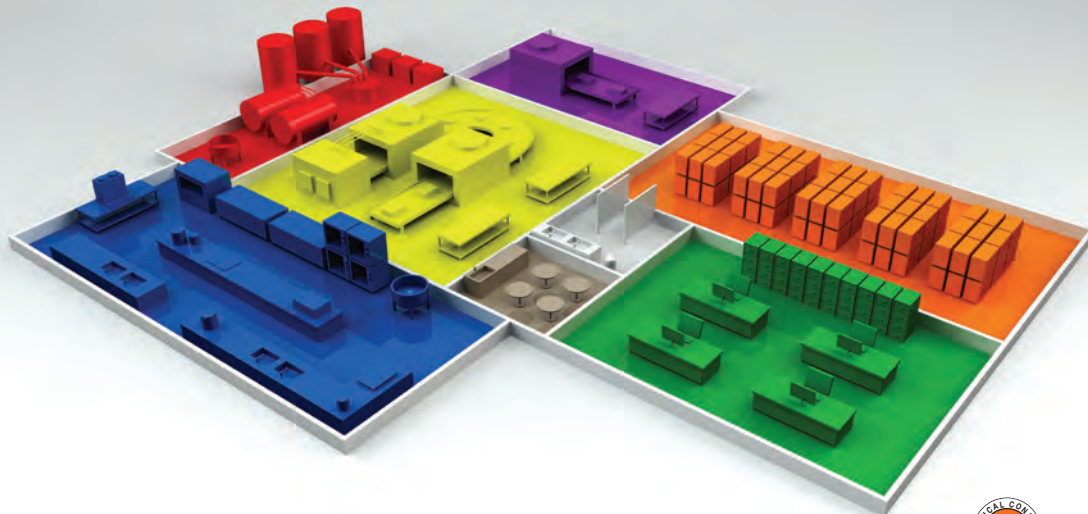

#### Plant Sanitation Guide

Step-On Containers are perfect for food processing applications. For more information, check out our Sanitary Maintenance Catalog.



### Office Wastebaskets

- Economical polypropylene containers withstand everyday use
- Smooth rims, rounded edges, and corners add structural support and make cleaning easy
- Smooth inner surface makes cleaning easy



### Fire Resistant Wastebaskets

- Ideal for use in areas or applications requiring an extra degree of fire protection including schools, health care, and hospitality
- Non-metallic BMC containers with textured finish minimizes appearance of scuffs and scratches
- UL Listed



Prod No	Description	Color	Pack	Cs Wt/Cube
<b>Step-On Beige Containers with Color-Coded Lids</b>				
346144	12 gal Step-On Container	02, 05, 06	1 ea	7.91/3.55
346145	18 gal Step-On Container	02, 05, 06, 09, 14	1 ea	12.68/4.79
346146	23 gal Step-On Container	02, 05, 06, 09, 14	1 ea	15.40/5.70
<b>Office Wastebaskets</b>				
342913	13 qt Office Wastebasket	03, 06, 23	12 ea	42.24/2.07
342928	28 qt Office Wastebasket	03, 06, 23	12 ea	51.48/4.02
342941	41 qt Office Wastebasket	03, 06, 23	12 ea	88.00/5.90
<b>Fire Resistant Wastebaskets</b>				
342915	14 qt Fire Resistant Wastebasket	03	6 ea	20.00/0.67
342927	28 qt Fire Resistant Wastebasket	03	6 ea	33.00/1.22
342940	41 qt Fire Resistant Wastebasket	03	4 ea	32.00/3.07

# RECYCLE CONTAINERS & ACCESSORIES

- Most waste container lines available in recycle colors
- Two-sided recycle imprint on all containers except the 343021REC Half Round Centurian and the 345050REC Rolling Container

## Bronco™ Recycle Waste Containers & Lids



341032REC



341032REC

341033REC

## Centurian™ Recycle Waste Containers & Lids



343527REC

343523REC



343937REC

343935REC



343022

343021REC

## TrimLine™ Recycle Containers



342023CMP



342027REC

342023REC



342026REC

342023REC

## Carlisle Roll-Away Recycle Container



345050REC



## 56 Gallon Recycle Container



344057REC

344056REC



**Office Recycle Wastebaskets**



342913REC



Black(03)



Green(09)



Blue(14)



**Recycle Label Kit**

34RECLBL

Includes one set of eleven color-coded symbol labels and three sets of eleven word labels in English, Spanish and French

Prod No	Description	Color	Pack	Cs Wt/Cube
<b>Bronco Recycle Waste Containers &amp; Lids</b>				
341020REC Δ	20 gal Recycle Waste Container	09, 14	6 ea	34.80/10.97
341021REC Δ	20 gal Recycle Lid with 8" Hole	09, 14	6 ea	7.65/4.57
341032REC Δ	32 gal Recycle Waste Container	09, 14	4 ea	34.40/13.18
341033REC Δ	32 gal Recycle Lid with 8" Hole	09, 14	4 ea	7.65/2.47
341044REC Δ	44 gal Recycle Waste Container	09, 14	3 ea	38.40/10.24
341045REC Δ	44 gal Recycle Lid with 8" Hole	14	3 ea	8.70/2.06
<b>Centurian Recycle Waste Containers &amp; Lids</b>				
343021REC	21 gal Half Round Centurian Recycle Container	14	4 ea	6.51/3.99
343022	Half Round Centurian Lid for 343021REC	03	4 ea	9.20/3.44
343523REC	23 gal Tall Square Centurian Recycle Container	14	4 ea	6.70/3.82
343526REC	Paper Recycle Centurian Lid for 343523REC	14	4 ea	9.0/2.50
343527REC	Bottle/Can Recycle Centurian Lid for 343523REC	14	4 ea	9.0/2.50
343935REC	35 gal Recycle Centurian Square Waste Receptacle	14	4 ea	7.35/6.62
343950REC	50 gal Recycle Centurian Square Waste Receptacle	14	4 ea	9.00/8.19
343936REC	Bottle/Can Recycle Centurian Lid for 343935REC, 343950REC	14	4 ea	5.0/4.12
343937REC	Paper Recycle Centurian Lid for 343935REC, 343950REC	14	4 ea	5.0/2.65
<b>TrimLine Recycle &amp; Compost Containers &amp; Lids</b>				
342015REC	15 gal TrimLine Recycle Container	14	4 ea	5.7/3.16
342023REC	23 gal TrimLine Recycle Container	09, 14	4 ea	29.60/5.91
342023CMP	23 gal TrimLine Compost Container	09	4 ea	29.60/5.91
342026REC	Paper Recycle Lid for 343023REC & 342015REC	14	4 ea	4.25/1.82
342027REC	Bottle/Can Recycle Lid for 343023REC & 342015REC	14	4 ea	4.25/1.82
342025	TrimLine Handled Lid	03, 09, 14	4 ea	5.10/0.90
<b>Carlisle Roll-Away Recycle Container</b>				
345050REC Δ	50 gal Recycle Rolling Container	14	2 ea	42.80/16.48
<b>56 Gallon Recycle Container &amp; Lid</b>				
344056REC	56 gal Recycle Waste Container	14	1 ea	16.50/11.68
344057REC	Recycle Lid for 344056REC	14	1 ea	1.50/7.88
<b>Office Recycle Wastebaskets</b>				
342913REC	13 qt Office Recycle Wastebasket	14	12 ea	42.24/2.07
342928REC	28 qt Office Recycle Wastebasket	14	12 ea	51.48/4.02
342941REC	41 qt Office Recycle Wastebasket	14	12 ea	88.00/5.90
<b>Recycle Label Kit</b>				
34RECLBL	Recycle Label Kit	—	1 ea	0.30/0.01

NSF Listed products are designated with a Δ

# TILT TRUCKS

## Tilt Trucks

- Perfect for transporting bulky loads and/or consolidating smaller loads for more efficient transport
- Durable rotationally molded construction with sturdy, reinforced rim and molded-in handles
- Smooth inner surface makes cleaning easy
- Textured outer surface hides scratches and helps maintain daily appearance
- Easy on/off wheels for quick replacement
- Rear wheels: 5" swivel casters with rubber tread
- Front wheels: 12" HDPE injection molded wheels
- Made of post consumer recycled material
- Meets EPA recommended recovered materials content levels for office recycling containers and waste receptacles and is perfect for specifying on school and government agency bids



TT175



TT005



TT110



Black(03)

Prod No	Description	Weight Capacity	Color	Pack	Cs Wt/Cube
<b>Tilt Trucks</b>					
TT005	.5 Cubic Yard Utility Duty Tilt Truck	400 lb/182 kg	03	1 ea	80.25/36.59
TT105	.5 Cubic Yard Standard Duty Tilt Truck	825 lb/374 kg	03	1 ea	87.25/36.59
TT175	.75 Cubic Yard Standard Duty Tilt Truck	825 lb/374 kg	03	1 ea	100.00/42.99
TT010	1 Cubic Yard Utility Duty Tilt Truck	825 lb/374 kg	03	1 ea	124.25/59.58
TT110	1 Cubic Yard Standard Duty Tilt Truck	1200 lb/544 kg	03	1 ea	130.25/59.58



# CASH'N CARRY

Carlisle is proud to offer our innovative products in a colorful, attention getting packaging designed in shelf-friendly packs which include UPC bar codes for easy check out.

<b>Product</b>	<b>Page</b>
Basting Brushes . . . . .	.284
Bronco Waste Container Lids . . . . .	.288
Bucket/Wringer & Floor Signs . . . . .	.287
Cafe Tray Banded Packs . . . . .	.278
Carts	
Bussing & Transport Carts . . . . .	.288
Janitorial Carts . . . . .	.288
Utility Cart . . . . .	.288
Coldmaster Ice Cream Server . . . . .	.277
Cookware	
Excalibur Fry Pans . . . . .	.280
SSAL 2000 Fry Pans . . . . .	.280
Standard Weight Aluminum Cookware . . . . .	.282
Teflon Select Fry Pans . . . . .	.281
Traditional Aluminum Fry Pans . . . . .	.281
Versata Select Cookware . . . . .	282 & 283
Versata Select Fry Pans . . . . .	.280
Dallas Ware . . . . .	.274
Dishers . . . . .	.284
Double Bucket Mopping Systems . . . . .	.287
Duo-Pan Dust & Lobby Pan . . . . .	.286
Food Pans . . . . .	.284

<b>Product</b>	<b>Page</b>
Hand & Nail Brush . . . . .	.286
Heat Lamps . . . . .	.277
J-Jars . . . . .	.276
Multi-Surface Floor Sweeper . . . . .	.286
Peeler . . . . .	.284
Petal Mist Bowls & Plates . . . . .	.274
Pump Kit . . . . .	.278
Ramekins . . . . .	.276
Roll 'N Grip Plus . . . . .	.286
Sauce Cups . . . . .	.276
Soup Server, Electric . . . . .	.277
Spatulas & Scrapers . . . . .	.284
Store 'N Pour . . . . .	.278
Sugar Caddies . . . . .	.276
Sweep Complete . . . . .	.288
Swivel Scrub Floor Brushes . . . . .	.286
Syrup Pitchers . . . . .	.276
Tip Trays . . . . .	.278
Tulip Dishes . . . . .	.274
Tumblers . . . . .	.275
Water Pan, Electric . . . . .	.277

# CASH 'N CARRY: DINNERWARE & DRINKWARE



Carlisle's Cash 'N Carry catalog section points out the number of available products for this growing segment. Cash 'N Carry products offer colorful, attention getting packaging designed to stand on its own. Multilingual features and benefits provide the product information your customers need. Shelf-friendly packs include UPC bar codes for easy check out.

## Dallas Ware® Shrink Wrap Packs

For a complete listing of Dallas Ware Dinnerware see pages 14 & 15

Note: Melamine Dinnerware is not recommended for microwave



43500-8



4530-8

## Tulip Dish Shrink Wrap Packs

For a complete listing of Tulip Dishes see page 23

## Petal Mist® Shrink Wrap Packs

For a complete listing of Petal Mist Plates & Bowls see page 24



6904-8



6956-8





## SAN Stackable™ Tumbler Box Packs

For a complete listing of SAN Stackable Tumblers see pages 32



5216-81

5216-8



5224-8

## SAN Stackable Tumbler Sleeve Packs

For a complete listing of SAN Stackable Tumblers see page 32



Clear(07)



Ruby(10)



Amber(13)



Tan(25)



Ice Blue(54)

Prod No	Description	Color	Pack	Packs Per Case	Cs Wt/Cube
<b>Dallas Ware Shrink Wrap Packs</b>					
43500-8 Δ	10.25" Dinner Plate	25	12 ea	4 pks	40.00/1.63
43501-8 Δ	9" Dinner Plate	25	12 ea	4 pks	27.00/1.00
43502-8 Δ	8" Luncheon Plate	25	12 ea	4 pks	22.00/0.70
43520-8 Δ	16 oz, 5.75" Nappie Bowl	25	12 ea	4 pks	15.60/0.93
43531-8 Δ	4.75 oz, 4.5" Fruit Bowl	25	12 ea	4 pks	6.60/0.32
43540-8 Δ	8 oz, 3.75" Bouillon Cup	25	12 ea	2 pks	4.40/0.17
43560-8 Δ	12" x 8.5" Oval Platter	25	12 ea	2 pks	13.40/0.65
43563-8 Δ	9.25" x 6.25" Oval Platter	25	12 ea	2 pks	10.00/0.35
<b>Tulip Dish Shrink Wrap Packs</b>					
4530-8 Δ	5 oz, 3.75" SAN Tulip Dessert Dish	07	6 ea	4 pks	2.45/0.21
4530-9 Δ	5 oz, 3.75" SAN Tulip Dessert Dish	07	12 ea	4 pks	4.62/0.33
4531-8 Δ	5 oz, 4.625" SAN Tulip Berry Dish	07	12 ea	4 pks	5.50/0.32
<b>Petal Mist Shrink Wrap Packs</b>					
6904-8 Δ	6", 18 oz, Bowl	07	4 ea	6 pks	7.30/0.53
6954-8 Δ	7.5" Plate	07	4 ea	6 pks	10.35/0.40
6907-8 Δ	8", 23.9 oz Soup/Salad Plate	07	4 ea	6 pks	8.28/0.66
6956-8 Δ	9" Plate	07	4 ea	6 pks	13.62/1.16
<b>SAN Stackable Tumbler Box Packs</b>					
5526-8	8 oz SAN Stackable Tumbler	07, 10, 13	12 ea	6 pks	8.40/0.64
5212-8	12 oz SAN Stackable Tumbler	07, 10, 13, 54	12 ea	6 pks	9.50/0.77
5216-8	16 oz SAN Stackable Tumbler	07, 10, 13, 54	12 ea	6 pks	11.10/0.99
5220-8	20 oz SAN Stackable Tumbler	07, 10, 13, 54	12 ea	6 pks	13.25/1.19
5224-8	24 oz SAN Stackable Tumbler	07, 10, 13	12 ea	6 pks	17.77/1.42
<b>SAN Stackable Tumbler Sleeve Pack</b>					
5501-81	5 oz SAN Stackable Tumbler	07, 10, 13	6 ea	12 pks	6.80/0.52
5526-81	8 oz SAN Stackable Tumbler	07, 10, 13	6 ea	12 pks	8.40/0.64
5506-81	9.5 oz SAN Stackable Tumbler	07, 10, 13	6 ea	12 pks	10.25/0.72
5212-81	12 oz SAN Stackable Tumbler	07, 10, 13	6 ea	12 pks	12.45/0.95
5216-81	16 oz SAN Stackable Tumbler	07, 10, 13	6 ea	12 pks	15.40/1.12
5220-81	20 oz SAN Stackable Tumbler	07, 10, 13	6 ea	12 pks	17.55/1.34
5224-81	24 oz SAN Stackable Tumbler	07, 10, 13	6 ea	12 pks	20.10/1.51
5532-81	32 oz SAN Stackable Tumbler	07, 10, 13	3 ea	16 pks	16.55/1.74

NSF Listed products are designated with a Δ

# CASH 'N CARRY: TABLETOP

## Melamine Ramekin Shrink Wrap Packs

For a complete listing of Melamine Ramekins see page 46

Note: Melamine Dinnerware is not recommended for microwave



0845-8



S275-8

## SAN Ramekin and Sauce Cup Shrink Wrap Packs

For a complete listing of SAN Ramekins and Sauce Cups see page 77

## Sugar Caddy Shrink Wrap Pack

For a complete listing of Sugar Caddies see page 48



4550-8



4560-8



## Syrup Pitcher Shrink Wrap Pack

For a complete listing of Syrup Pitchers see page 48

## J-Jar Shrink Wrap Pack

For a complete listing of J-Jars see page 49



4574-8



607830EW



### Electric Water Pan

For a complete listing of Electric Water Pans see page 85

### Electric Soup Server

For a complete listing of Electric Soup Servers see page 102



0588



CM1012



### Coldmaster® Ice Cream Server with Lid

For a complete listing of Coldmaster Products see pages 92 - 95

### Two Bulb Adjustable Heat Lamp Box Pack

For a complete listing of Flexiglow Heat Lamps see page 156



HL7237-8



White(02)



Black(03)



Clear(07)



Bone(42)

Prod No	Description	Color	Pack	Packs Per Case	Cs Wt/Cube
<b>Melamine Ramekin Shrink Wrap Packs</b>					
S275-8 Δ	1.5 oz Smooth Ramekin	42	12 ea	4 pks	5.60/0.33
S285-8 Δ	4 oz Smooth Ramekin	42	12 ea	4 pks	9.70/0.48
S279-8 Δ	2 oz Fluted Ramekin	42	12 ea	4 pks	7.10/0.37
S282-8 Δ	3 oz Fluted Ramekin	42	12 ea	4 pks	9.00/0.51
S287-8 Δ	4 oz Fluted Ramekin	42	12 ea	4 pks	10.55/0.57
0844-8 Δ	2 oz Fluted Ramekin	42	12 ea	4 pks	3.20/0.24
0845-8 Δ	4.5 oz Fluted Ramekin	42	12 ea	4 pks	5.65/0.50
<b>SAN Ramekin and Sauce Cup Shrink Wrap Packs</b>					
0844-8 Δ	2 oz Fluted Ramekin	02	12 ea	4 pks	3.20/0.24
0845-8 Δ	4.5 oz Fluted Ramekin	02	12 ea	4 pks	5.65/0.50
<b>Sugar Caddy Shrink Wrap Pack</b>					
4550-8 Δ	Standard Caddy (holds 20 pkts)	03	6 ea	4 pks	5.60/0.36
<b>Syrup Pitcher Shrink Wrap Pack</b>					
4560-8 Δ	2 oz Syrup Pitcher/Creamer	07	6 ea	6 pks	4.95/0.33
<b>J-Jar Shrink Wrap Pack</b>					
4574-8 Δ	8 oz J-Jar with Lid	07	3 ea	8 pks	5.40/0.67
<b>Electric Water Pan</b>					
607830EW	Electric Water Pan	—	1 ea	1 pk	6.52/1.50
<b>Electric Soup Server</b>					
0588 Δ	Electric Kettle with Inset, Lid & Ladle	03	1 ea	1 pk	17.19/2.81
<b>Coldmaster Ice Cream Server with Lid</b>					
CM1012 Δ	3 gal Coldmaster Ice Cream Server	02, 03	1 ea	1 pk	7.25/1.05
<b>Two Bulb Adjustable Heat Lamp Pack</b>					
HL7237-8 Δ	Two Bulb Adjustable Heat Lamp Pack	00	1 ea	1 pk	9.40/4.54

NSF Listed products are designated with a Δ

# CASH 'N CARRY: BAR SUPPLIES

## Store 'N Pour®

For a complete listing of Store 'N Pour items see page 112

PS601N-8



PS601N-81



38310

## Pump Kit

For a complete listing of Pump Kits see page 104

## Tip Tray Shrink Wrap Pack

For a complete listing of Trip Trays see page 117



3020-8



CT1418-81



## Cafe Tray Banded Packs

For a complete listing of Cafe Trays see page 125



Be sure to check out our Marko Catalog for our other great Cash 'N Carry items such as:

- Clips
- Napkins
- Tablecloths
- Skirting

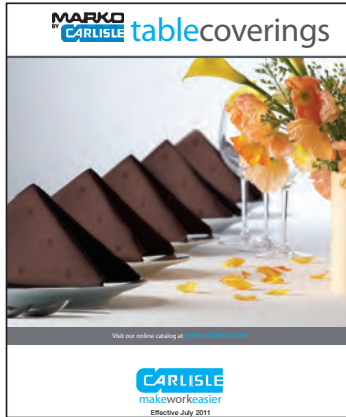

Assorted(00)



Black(03)



Red(05)



Clear(07)



Blue(14)



Brown(69)

Prod No	Description	Color	Pack	Packs Per Case	Cs Wt/Cube
<b>Store 'N Pour</b>					
PS601N-8	Quart Complete, 3-piece set	00	3 ea	4 pks	5.70/1.50
PS601N-81	Quart Complete with Individual Wrap and Color Label	07	1 ea	12 pks	4.60/0.89
<b>Pump Kit</b>					
38310	Pump Kit with Standard Pump & 5 Lids Including 1.5", 4.31", 4.31"SP, 4.69", & 6.31" Lids	—	1 ea	6 pks	2.90/0.39
<b>Tip Tray Shrink Wrap Pack</b>					
3020-8 Δ	Check Holder Trip Tray, 4.38" x 7.75"	03	6 ea	2 pks	1.80/0.14
<b>Cafe Tray Banded Packs</b>					
CT1014-81 Δ	10" x 14" Standard Tray	03, 05, 14, 69	6 ea	4 pks	10.95/0.52
CT1216-81 Δ	12" x 16" Standard Tray	03, 05, 14, 69	6 ea	4 pks	19.00/0.80
CT1418-81 Δ	14" x 18" Standard Tray	03, 05, 14, 69	6 ea	2 pks	12.50/0.61

NSF Listed products are designated with a Δ

# CASH 'N CARRY: FRYING PANS

60712RS



## SSAL 2000™ Fry Pans

For a complete listing of SSAL 2000 Fry Pans see page 142

Recommended covers are listed in parenthesis after product description

## Versata Select™ Fry Pans

For a complete listing of Versata Select Fry Pans see page 144

Recommended covers are listed in parenthesis after product description



601012



60910XRS

## Excalibur® Fry Pans

For a complete listing of Excalibur Fry Pans see page 143

Recommended covers are listed in parenthesis after product description  
Excalibur® is a registered trademark of Whitford B. U. Corp.



60908SERS

## Teflon Select® Fry Pans

For a complete listing of Teflon Select Fry Pans see page 142

Recommended covers are listed in parenthesis after product description  
Teflon® is a registered trademark of E.I. DuPont® DeNemours & Co., Inc.

## Traditional Aluminum Fry Pans

For a complete listing of Traditional Aluminum Fry Pans see page 142

Recommended covers are listed in parenthesis after product description



60908RS

Prod No	Description	Color	Pack	Packs Per Case	Cs Wt/Cube
<b>SSAL 2000 Fry Pans</b>					
60708RS $\Delta$	8" SSAL Fry Pan (604008)	—	1 ea	12 pks	17.00/0.69
60710RS $\Delta$	10" SSAL Fry Pan (604010)	—	1 ea	6 pks	16.00/0.68
60712RS $\Delta$	12" SSAL Fry Pan (604012)	—	1 ea	6 pks	19.00/0.78
<b>Versata Select Fry Pans</b>					
601008 $\Delta$	7" Versata Select Fry Pan (606007)	—	1 ea	1 pk	1.90/0.11
601009 $\Delta$	10" Versata Select Fry Pan (606009)	—	1 ea	1 pk	2.42/0.45
601012 $\Delta$	12" Versata Select Fry Pan (606122)	—	1 ea	1 pk	3.64/0.34
601014 $\Delta$	14" Versata Select Fry Pan (606014)	—	1 ea	1 pk	5.11/0.47
601008X	7" Versata Select Coated Fry Pan (606007)	—	1 ea	1 pk	1.90/0.11
601009X	10" Versata Select Coated Fry Pan (606009)	—	1 ea	1 pk	2.42/0.45
601012X	12" Versata Select Coated Fry Pan (606122)	—	1 ea	1 pk	3.64/0.34
601014X	14" Versata Select Coated Fry Pan (606014)	—	1 ea	1 pk	5.11/0.47
<b>Excalibur Fry Pans</b>					
60907XRS $\Delta$	7" Excalibur Fry Pan (60907C)	—	1 ea	12 pks	15.00/0.53
60908XRS $\Delta$	8" Excalibur Fry Pan (60908C)	—	1 ea	12 pks	19.00/0.77
60910XRS $\Delta$	10" Excalibur Fry Pan (60910C)	—	1 ea	6 pks	16.00/0.76
60912XRS $\Delta$	12" Excalibur Fry Pan (60912C)	—	1 ea	6 pks	21.00/1.13
60914XRS $\Delta$	14" Excalibur Fry Pan (60914C)	—	1 ea	3 pks	15.00/1.42
<b>Teflon Select Fry Pans</b>					
60907SERS $\Delta$	7" Teflon Select Fry Pan (60907C)	—	1 ea	12 pks	15.00/0.53
60908SERS $\Delta$	8" Teflon Select Fry Pan (60908C)	—	1 ea	12 pks	19.00/0.77
60910SERS $\Delta$	10" Teflon Select Fry Pan (60910C)	—	1 ea	6 pks	16.00/0.76
60912SERS $\Delta$	12" Teflon Select Fry Pan (60912C)	—	1 ea	6 pks	21.00/1.13
60914SERS $\Delta$	14" Teflon Select Fry Pan (60914C)	—	1 ea	3 pks	15.00/1.42
<b>Traditional Aluminum Fry Pans</b>					
60907RS $\Delta$	7" Aluminum Fry Pan (60907C)	—	1 ea	12 pks	15.00/0.53
60908RS $\Delta$	8" Aluminum Fry Pan (60908C)	—	1 ea	12 pks	19.00/0.77
60910RS $\Delta$	10" Aluminum Fry Pan (60910C)	—	1 ea	6 pks	16.00/0.76
60912RS $\Delta$	12" Aluminum Fry Pan (60912C)	—	1 ea	6 pks	21.00/1.13
60914RS $\Delta$	14" Aluminum Fry Pan (60914C)	—	1 ea	3 pks	15.00/1.42

NSF Listed products are designated with a  $\Delta$

# CASH 'N CARRY: COOKWARE

601112



601025



601175

## Versata Select™ Cookware

For a complete listing of Versata Select Cookware see pages 144 & 145

Recommended covers are listed in parenthesis after product description



## Standard Weight Aluminum Cookware

For a complete listing of Standard Weight Aluminum Cookware see page 146

Recommended covers are listed in parenthesis after product description

61260



61220



61210

61120  
61125



61130





Be sure to check out these pieces and more in the **Cookware** section on pages 141-152 of this catalog.

Pictured Right: Versata Select Cookware Line



Prod No	Description	Color	Pack	Packs Per Case	Cs Wt/Cube
<b>Versata Select Stock Pots</b>					
601109 Δ	9 qt Versata Select Stock Pot (606009)	—	1 ea	1 pk	4.76/0.61
601112 Δ	12 qt Versata Select Stock Pot (606010)	—	1 ea	1 pk	5.47/0.76
601116 Δ	16 qt Versata Select Stock Pot (606011)	—	1 ea	1 pk	6.99/0.98
601125 Δ	24 qt Versata Select Stock Pot (606013)	—	1 ea	1 pk	10.00/1.85
601132 Δ	32 qt Versata Select Stock Pot (606014)	—	1 ea	1 pk	11.68/1.73
601144 Δ	40 qt Versata Select Stock Pot (606015)	—	1 ea	1 pk	15.87/2.10
601164 Δ	60 qt Versata Select Stock Pot (606016)	—	1 ea	1 pk	18.38/3.18
<b>Versata Select Sauce Pots</b>					
601175 Δ	6 qt Versata Select Sauce Pot (606009)	—	1 ea	1 pk	4.41/0.44
601111 Δ	10 qt Versata Select Sauce Pot (606011)	—	1 ea	1 pk	5.73/0.65
601119 Δ	18 qt Versata Select Sauce Pot (606014)	—	1 ea	1 pk	8.49/0.66
601123 Δ	22 qt Versata Select Sauce Pot (606014)	—	1 ea	1 pk	9.55/1.29
601133 Δ	32 qt Versata Select Sauce Pot (606015)	—	1 ea	1 pk	11.11/1.66
601146 Δ	40 qt Versata Select Sauce Pot (606017)	—	1 ea	1 pk	16.25/2.26
<b>Versata Select Sauce Pans</b>					
601025 Δ	2.5 qt Versata Select Sauce Pan (606006)	—	1 ea	1 pk	2.49/0.20
601045 Δ	4.5 qt Versata Select Sauce Pan (606007)	—	1 ea	1 pk	3.31/1.43
601075 Δ	7 qt Versata Select Sauce Pan (606009)	—	1 ea	1 pk	4.43/0.52
<b>Standard Weight Stock Pots</b>					
61210 Δ	10 qt Standard Weight Stock Pot (61210C)	—	1 ea	1 pk	4.00/0.53
61212 Δ	12 qt Standard Weight Stock Pot (61212C)	—	1 ea	1 pk	4.30/0.79
61216 Δ	16 qt Standard Weight Stock Pot (61216C)	—	1 ea	1 pk	5.20/0.97
61220 Δ	20 qt Standard Weight Stock Pot (61220C)	—	1 ea	1 pk	6.50/1.20
61224 Δ	24 qt Standard Weight Stock Pot (61224C)	—	1 ea	1 pk	6.50/1.43
61232 Δ	32 qt Standard Weight Stock Pot (61232C)	—	1 ea	1 pk	9.10/1.89
61240 Δ	40 qt Standard Weight Stock Pot (61240C)	—	1 ea	1 pk	9.80/2.30
61260 Δ	60 qt Standard Weight Stock Pot (61260C)	—	1 ea	1 pk	13.80/3.42
61280 Δ	80 qt Standard Weight Stock Pot (61280C)	—	1 ea	1 pk	15.90/4.27
61200 Δ	80 qt Standard Weight Stock Pot (61280C)	—	1 ea	1 pk	17.60/4.94
<b>Standard Weight Braziers</b>					
61115 Δ	15 qt Standard Weight Brazier (61232C)	—	1 ea	1 pk	9.24/0.81
61120 Δ	20 qt Standard Weight Brazier (61120C)	—	1 ea	1 pk	11.66/0.92
61125 Δ	25 qt Standard Weight Brazier (61125C)	—	1 ea	1 pk	11.66/0.92
61130 Δ	30 qt Standard Weight Brazier (61130C)	—	1 ea	1 pk	13.64/1.59
<b>Standard Weight Sauce Pans</b>					
61302 Δ	2.5 qt Standard Weight Sauce Pan (61302C)	—	1 ea	1 pk	14.00/2.01
61305 Δ	5 qt Standard Weight Sauce Pan (61305C)	—	1 ea	1 pk	19.00/4.66
61308 Δ	8.5 qt Standard Weight Sauce Pan (61308C)	—	1 ea	1 pk	28.87/3.50
61702 Δ	2.5 qt Tapered Sauce Pan (61702C)	—	1 ea	1 pk	9.50/0.78
61704 Δ	4.5 qt Tapered Sauce Pan (61704C)	—	1 ea	1 pk	12.80/3.17
61707 Δ	6 qt Tapered Sauce Pan (61707C)	—	1 ea	1 pk	17.00/2.92
61708 Δ	8.5 qt Tapered Sauce Pan (61708C)	—	1 ea	1 pk	20.70/3.82
61710 Δ	10 qt Tapered Sauce Pan (61710C)	—	1 ea	1 pk	22.00/4.87

NSF Listed products are designated with a Δ

# CASH 'N CARRY: KITCHEN ACCESSORIES



## Silicone Basting Brushes

For a complete listing of Silicone Basting Brushes see page 162



40403

## Disher Box Pack

For a complete listing of Dishers see page 164



60300-10



44141



44145



44131



44135

## Spatulas & Scrapers

For a complete listing of Spatula and Scrapers see page 170



6020

## Stainless Steel Peeler

For a complete listing of Peelers see page 172

## Top Notch® Food Pan Banded Packs

For a complete listing of Top Notch Food Pans see pages 178-181



10221-8

10421-8





White(02)

Red(05)

Clear(07)

Amber(13)

Prod No	Description	Color	Pack	Packs Per Case	Cs Wt/Cube
<b>Silicone Basting Brushes</b>					
40403	2" Silicone Basting Brush	05	1 ea	12 pks	2.00/0.13
40405	3" Silicone Basting Brush	05	1 ea	12 pks	2.00/0.13
<b>Disher Box Packs</b>					
60300-6 Δ	4.66 oz Disher with White Handle	—	1 ea	12 pks	6.00/0.52
60300-8 Δ	4 oz Disher with Gray Handle	—	1 ea	12 pks	6.00/0.52
60300-10 Δ	3.75 oz Disher with Ivory Handle	—	1 ea	12 pks	6.00/0.52
60300-12 Δ	3.25 oz Disher with Green Handle	—	1 ea	12 pks	6.00/0.52
60300-16 Δ	2.75 oz Disher with Blue Handle	—	1 ea	12 pks	5.00/0.35
60300-20 Δ	2 oz Disher with Yellow Handle	—	1 ea	12 pks	5.00/0.39
60300-24 Δ	1.75 oz Disher with Red Handle	—	1 ea	12 pks	5.00/0.37
60300-30 Δ	1.25 oz Disher with Black handle	—	1 ea	12 pks	5.00/0.35
60300-40 Δ	.875 oz Disher with Orchid handle	—	1 ea	12 pks	5.00/0.35
<b>Spatulas &amp; Scrapers</b>					
44141	10" Spatula	02	1 ea	12 pks	1.50/0.22
44142	14" Spatula	02	1 ea	12 pks	1.50/0.22
44143	16" Spatula	02	1 ea	12 pks	1.50/0.22
44144	10" Scraper	02	1 ea	12 pks	1.50/0.22
44145	14" Scraper	02	1 ea	12 pks	1.50/0.14
44146	16" Scraper	02	1 ea	12 pks	1.50/0.43
44131	10.5" High Heat Spatula	02	1 ea	12 pks	1.50/0.14
44132	14" High Heat Spatula	02	1 ea	12 pks	1.50/0.22
44133	16.25" High Heat Spatula	02	1 ea	12 pks	1.50/0.14
44134	10.5" High Heat Scraper	02	1 ea	12 pks	1.50/0.14
44135	14" High Heat Scraper	02	1 ea	12 pks	1.50/0.14
44136	16.25" High Heat Scraper	02	1 ea	12 pks	1.50/0.14
<b>Stainless Steel Peeler</b>					
6020	Peeler with Stainless Steel Blade	—	1 ea	6 pks	1.00/1.56
<b>Top Notch Polycarbonate Food Pan Banded Packs</b>					
10220-8 Δ	Pan – 2.5" (3.6 qt)	07	3 ea	2 pks	5.65/0.56
10221-8 Δ	Pan – 4" (5.6 qt)	07	3 ea	2 pks	7.60/0.89
10222-8 Δ	Pan – 6" (8.7 qt)	07	3 ea	2 pks	9.50/1.27
10260-8 Δ	Pan – 2.5" (2.4 qt)	07	3 ea	2 pks	4.45/0.46
10261-8 Δ	Pan – 4" (3.8 qt)	07	3 ea	2 pks	5.95/0.73
10262-8 Δ	Pan – 6" (5.7 qt)	07	3 ea	2 pks	7.15/0.88
10280-8 Δ	Pan – 2.5" (1.7 qt)	07	3 ea	2 pks	3.65/0.36
10281-8 Δ	Pan – 4" (2.8 qt)	07	3 ea	2 pks	4.65/0.55
10282-8 Δ	Pan – 6" (4.0 qt)	07	3 ea	2 pks	6.10/0.69
10300-8 Δ	Pan – 2.5" (1.1 qt)	07	3 ea	2 pks	2.35/0.26
10301-8 Δ	Pan – 4" (1.7 qt)	07	3 ea	2 pks	3.10/0.35
10302-8 Δ	Pan – 6" (2.5 qt)	07	3 ea	2 pks	3.80/0.45
10320-8 Δ	Pan – 2.5" (0.7 qt)	07	3 ea	2 pks	5.65/0.56
10321-8 Δ	Pan – 4" (1.0 qt)	07	3 ea	2 pks	2.30/0.22
<b>Top Notch High Heat Food Pans</b>					
10420-8 Δ	Pan – 2.5" (3.6 qt)	13	3 ea	2 pks	5.90/0.57
10421-8 Δ	Pan – 4" (5.6 qt)	13	3 ea	2 pks	8.00/0.89
10422-8 Δ	Pan – 6" (8.7 qt)	13	3 ea	2 pks	9.95/1.27
10460-8 Δ	Pan – 2.5" (2.4 qt)	13	3 ea	2 pks	4.65/0.46
10461-8 Δ	Pan – 4" (3.8 qt)	13	3 ea	2 pks	5.95/0.73
10462-8 Δ	Pan – 6" (5.7 qt)	13	3 ea	2 pks	7.50/0.89
10480-8 Δ	Pan – 2.5" (1.7 qt)	13	3 ea	2 pks	3.80/0.36
10481-8 Δ	Pan – 4" (2.8 qt)	13	3 ea	2 pks	4.75/0.55
10482-8 Δ	Pan – 6" (4.0 qt)	13	3 ea	2 pks	6.10/0.69
10500-8 Δ	Pan – 2.5" (1.1 qt)	13	3 ea	2 pks	2.31/0.26
10501-8 Δ	Pan – 4" (1.7 qt)	13	3 ea	2 pks	3.25/0.40
10502-8 Δ	Pan – 6" (2.5 qt)	13	3 ea	2 pks	4.05/0.45
10520-8 Δ	Pan – 2.5" (0.7 qt)	13	3 ea	2 pks	1.95/0.20
10521-8 Δ	Pan – 4" (1.0 qt)	13	3 ea	2 pks	2.45/0.26

NSF Listed products are designated with a Δ

# CASH 'N CARRY: BRUSHES & FLOOR CARE



40021

## Hand & Nail Brush

For a complete listing of Hand & Nail Brushes see page 209

## Swivel Scrub® Floor Brushes

For a complete listing of Swivel Scrub Floor Brushes see page 228



36399

365300



3638831

## Multi-Surface Floor Sweeper

For a complete listing of Multi-Surface Floor Sweepers see page 224

## Roll 'N Grip Plus

For a complete listing of Roll 'N Grip Plus see page 237



40737



36141003-1



361416

## Duo-Pan™ Dust & Lobby Pan Combos

For a complete listing of Duo-Pan Dust & Lobby Pans see page 224



### Bucket/Wringer & Floor Signs

For a complete listing of Bucket/Wringers & Floor Signs see page 247



36904

### Double Bucket Mopping Systems

For a complete listing of Double Bucket Mopping Systems see page 247



36906D



36906DW



Prod No	Description	Color	Pack	Packs Per Case	Cs Wt/Cube
<b>Hand &amp; Nail Brush</b>					
40021	5" Handle Hand & Nail Brush Kit	00	1 ea	12 pks	5.45/0.44
<b>Swivel Scrub Floor Brushes</b>					
365300	8" Heavy-Duty General Use Swivel Scrub with Nylon Grit Filament	14	1 ea	12 pks	9.50/0.68
3638831	8" Swivel Scrub with Polyester Bristles	03	1 ea	12 pks	8.86/0.70
365310	8" Swivel Scrub with Heavy Nylon Grit Bristles	27	1 ea	12 pks	9.50/0.68
36219663	8" Polypropylene-Fill Swivel Scrub with 48" Handle	03	1 ea	4 pks	6.12/1.84
<b>Multi-Surface Floor Sweepers</b>					
36399	9.5" Multi-Surface Sweeper	14	1 ea	4 pks	10.30/0.91
36400	12" Duo-Sweeper Floor Sweeper	14	1 ea	4 pks	12.00/1.11
<b>Roll 'N Grip Plus</b>					
40737	Roll 'N Grip Plus	00	1 ea	24 pks	35.00/2.68
<b>Duo-Pan Dust &amp; Lobby Pan Combo</b>					
361416	Duo-Pan II Dustpan Combo	03	1 ea	4 pks	12.00/1.56
36141003-1	12" Duo-Pan Plastic Upright Dustpan with Metal Handle	—	1 ea	1 pk	3.02/1.17
<b>Bucket/Wringer &amp; Floor Signs</b>					
36904	35 Qt. Bucket/Wringer with Side Press	04, 05, 09, 14, 69	1 ea	1 pk	19.1/3.15
36905	35 Quart Bucket with Down Press Wringer	04	1 ea	1 pk	13.88/3.83
36908	26 Quart Bucket/Wringer Combo	04, 05, 09, 14, 69	1 ea	1 pk	15.40/3.01
36909	Economy Wet Floor Sign (English/Spanish/German)	04	1 ea	6 pks	12.60/1.45
<b>Double Bucket Mopping Systems</b>					
36906D	35 qt Double Bucket Combo with Side Press Wringer	04	1 ea	1 pk	18.84/5.03
36906DW	35 qt Double Bucket Combo with Side Press Wringer	04	1 ea	1 pk	34.17/8.89

NSF Listed products are designated with a  $\Delta$

# CASH 'N CARRY: JANITORIAL SUPPLIES



## Sweep Complete™ Floor Sweeps & Handle

For a complete listing of Sweep Complete Floor Sweeps & Handle see pages 226 & 235

## Bussing & Transport Carts

For a complete listing of Bussing & Transport Carts see pages 255



CC2036

## Janitorial Carts

For a complete listing of Janitorial Carts see page 260

## Utility Cart

For a complete listing of Utility Carts see page 256 & 257



UC1940











JC1945SS

## Bronco™ Waste Container Lids

For a complete listing of Bronco Waste Containers & Lids see page 262



341033

-   
Aluminum(00)
-   
White(02)
-   
Black(03)
-   
Yellow(04)
-   
Red(05)
-   
Green(09)
-   
Blue(14)
-   
Gray(23)
-   
Orange(24)

Prod No	Description	Color	Pack	Packs Per Case	Cs Wt/Cube
<b>Floor Sweeps &amp; Handle</b>					
36219618	18" Sweep Complete Floor Sweep with Squeegee	14	1 ea	6 pks	17.47/1.95
36219624	24" Sweep Complete Floor Sweep with Squeegee	14	1 ea	6 pks	21.12/2.37
40224	60" 3-Piece Threaded Aluminum Handle, 1" D	00	1 ea	12 pks	13.00/0.80
<b>Bussing &amp; Transport Carts</b>					
CC2243 $\Delta$	42" x 23" Large Bussing & Transport Cart	03	1 ea	1 pk	69.00/9.89
CC2036 $\Delta$	18" x 36" Bussing and Transport Cart	03	1 ea	1 pk	43.82/7.58
<b>Janitorial Carts</b>					
JC1945S	Short Platform Janitorial Cart	23	1 ea	1 pk	33.00/4.45
JC1945L	Long Platform Janitorial Cart	23	1 ea	1 pk	41.00/4.49
<b>Utility Cart</b>					
UC1940	40" x 23" Utility Cart	23	1 ea	1 pk	45.05/5.29
<b>Bronco Waste Container Lids</b>					
341011 $\Delta$	10 gal Lid	02, 04, 05, 09, 14	1 ea	6 pks	5.50/0.77
341021 $\Delta$	20 gal Lid	02, 04, 05, 09, 14	1 ea	6 pks	7.65/4.57
341033 $\Delta$	32 gal Lid	02, 04, 05, 09, 14	1 ea	6 pks	7.65/2.47
341045 $\Delta$	44 gal Lid	02, 04, 05, 09, 14, 24	1 ea	6 pks	8.70/2.06
341056 $\Delta$	55 gal Lid	02, 04, 05, 09, 14	1 ea	6 pks	5.10/3.20

NSF Listed products are designated with a  $\Delta$

# Welcome to our **Reference Guide**

**Index**

Custom Imprinting . . . . .	292-297
Durus® Warranty . . . . .	304
Kitchen Brush Guide. . . . .	290 & 291
Replacement Parts. . . . .	298-303

Here, you will find basic information on how to get custom decorated or logo'd products and find replacement parts for Carlisle products you already have. The index at left will guide you through this section. Page references will direct you back to the catalog section where specific products are located. All information is listed in catalog order.

**Visit us online at [www.carlislefsp.com](http://www.carlislefsp.com)**

We also offer extensive on-line resources where you can find more in-depth information on all of our products. Our convenient Web site ( [www.carlislefsp.com](http://www.carlislefsp.com) ) is packed with everything you could ever need to know about our products and services. Information like:

- Complete Technical Specifications for all Carlisle products – including dimensions, capacities, material content, electrical information, and more
- Product Specification Sheets
- Care and Use Instructions
- Details on our many money-saving Warranties
- Dinnerware Shapes and Profiles
- Additional Replacement Parts
- Food Bar Pan Layouts
- OptiClean Glass Rack Sizing Guide – including convenient glass-to-rack reference guides for all major Drinkware manufacturers along with our exclusive Glass Rack Wizard
- Brush and Bristle Guides – to help you select the proper brush for any cleaning job

To access this and other helpful information, please go to [www.carlislefsp.com](http://www.carlislefsp.com).

You can locate all of our product Tech Specs – dimensions, capacities, material, and more by visiting our website and selecting the Tech Specs tab on the section intro. This information is also easily accessed from any of the individual product listings in our on-line catalog.

And to learn about all of our latest new products please be sure to visit [www.carlislefsp.com](http://www.carlislefsp.com).

Carlisle's easy to navigate web site also has other guides and helpful information to help you select the products that are right for you. You can also see how to qualify for rebates and other special offers direct from Carlisle that can save you hundreds of dollars on the professional quality foodservice and cleaning tools your operation uses every day.



# 21 Key Brushes



No	Prod No	Description	Page
1	40020	Hand and Nail Brush	209
2	40140	Polyester Bowl Brush	250
3	40025	Coffee Decanter Brush	212
4	40000	12" Carafe/Bottle Brush	206
5	4037400	Hot Basting Brush	160

No	Prod No	Description	Page
6	40111	L-Tipped Fryer Brush	212
7	40290	Broiler Master Grill Brush	214
8	40671	Wire Scratch Brush with Scraper	216
9	40164	Vegetable Brush	162
10	40401	Meteor® Pastry Brush	161





No	Prod No	Description	Page
11	4040505	Silicone Basting Brush	162
12	40423	Hi-Lo™ Floor Scrub	228
13	40146	Floor Drain Brush	249
14	40236	36" Plastic Drain Brush Handle	249
15	40144	Drain Opening Tool	249

No	Prod No	Description	Page
16	41881	24" Omni Sweep	226
17	36885	Duo-Sweep™ Angle Broom	222
18	40082	24" Double Foam Rubber Floor Squeegee	230
19	40501	20" Polyester Scrub Brush	210
20	40521	6" Cutting Board Brush	206
21	40541	8" Polyester Scrub Brush	210

# CUSTOM IMPRINTING

## Camera-Ready Artwork For Silkscreening

- Camera-ready artwork is required for ALL imprinting. Camera-ready art is defined as a sharp black and white image enlarged or reduced to proper size, ready for reproduction. Artwork must be clean with clear, crisp detail. Camera-ready artwork **DOES NOT INCLUDE** business cards, letterhead, or faxed-in logos. Artwork can also be sent on a CD, USB, or e-mailed (call to get address). Digital artwork must be high resolution 300 DPI in an EPS or TIFF format. Artwork should be sent in the original format in which it was created. Artwork must also be properly separated when more than one color is used.
- At customer's request, we will prepare camera-ready art at an artist fee of \$100.00/hour.
- Since the design possibilities are governed by the item to be imprinted, details of all artwork must be submitted to Carlisle FoodService Products for consideration before an order can be accepted.



### Samples

- With a firm order, we will provide ONE sample for approval before final production.
- A NET charge of \$75.00 must be paid in advance to request one imprint sample without a firm purchase order. This charge also applies if your order is cancelled after receipt of sample, prior to production. The \$75.00 NET charge is in addition to the set-up charge.

### Set-Up Charge

- \$50.00 net for one color, one side. \$25.00 net for each additional color and side.
- One-time film charge of \$15.00 net per color. Charge covers 8.5 " x 11" film; larger size film will cost more accordingly.

### Terms

- Delivery of plus or minus 10% within the quantity ordered constitutes fulfillment of the order and payment shall be made on the basis of actual delivery.

### Returns

- **Custom decorated products are not accepted for exchange or refund.**

### Case Lots

- All orders sold in full case lots only.

### Questions

- Contact your local Carlisle Sales Representative or your Customer Service Representative for more information.

## Silk Screening

### Product List A

Lead Time – 6 weeks from approval of sample.

Imprint Charge – \$.35 net each piece, per side, per color.

Prod No	Description	Max Imprint H x W	Min Order Qty
0240 *	10.5" Ladle	.5" x 3"	144 ea
0295 *	9.5" Carly Ladle	.25" x 2"	144 ea
0296 *	13.5" Carly Ladle	.25" x 3"	144 ea
0301	1.2 qt Classic Crock	3" x 13"	144 ea
0302	2.7 qt Classic Crock	4.5" x 11"	144 ea
0304	4 qt Classic Crock	4" x 9"	144 ea
0316	1.5 qt Classic Crock	1.5" x 11"	144 ea
0365 *	1.5 qt Supreme Crock (on lip)	.75" x 11"	144 ea
0372 *	2.7 qt Supreme Crock (on lip)	.75" x 11"	144 ea
4009 *	9" Salad Tong (Clear only)	.38" x 2"	144 ea
4109 *	9" Utility Tong (Clear only)	.38" x 2"	144 ea
4112 *	12" Utility Tong (Clear only)	.38" x 2.25"	144 ea
4206 *	6" Pom Tong (Clear only)	.38" x 1.25"	144 ea
4250	Handled Shaker Dredge	3" x 2.25"	144 ea
4260	Handled Shaker Dredge	3" x 2.25"	144 ea
4270	Handled Shaker Dredge	3" x 2.25"	144 ea
43052	10 oz Stackable Mug	1" x 7"	144 ea
4306	6 oz Scoop (print on side)	.5" x .5"	144 ea
4332	32 oz Scoop (print on side)	.25" x 3"	144 ea
43622	13.5 oz Liberty PC Goblet	.5" x 4"	1008 ea
43625	18 oz Liberty PC Double Old Fashion	.5" x 4"	1008 ea
43626	22 oz Liberty PC Hi-Ball	1" x 10.5"	1008 ea
43630	13 oz Liberty PC	4.33" x 7.81"	1008 ea
4364	64 oz Scoop (print on side)	2" x 3"	144 ea
4410 *	11" Solid Serving Spoon	.25" x 4"	144 ea
4411 *	11" Perforated Serving Spoon	.25" x 4"	144 ea
4420 *	13" Solid Serving Spoon	.25" x 4"	144 ea
4421 *	13" Perforated Serving Spoon	.25" x 4"	144 ea
4430 *	15" Solid Serving Spoon	.25" x 4"	144 ea
4431 *	15" Perforated Serving Spoon	.25" x 4"	144 ea
4450 *	.25 oz 8" Solid Buffet Spoon	.25" x 1.5"	144 ea
4460 *	.5 oz 8" Solid Buffet Spoon	.25" x 1.5"	144 ea
4470 *	.75 oz 10" Solid Buffet Spoon	.25" x 1.5"	360 ea
4471 *	.75 oz 10" Perforated Buffet Spoon	.25" x 1.5"	360 ea

\*Decorating limited to one color.

Prod No	Description	Max Imprint H x W	Min Order Qty
4512	12 oz Jumbo Soup Mug	1.25" x 8"	144 ea
4550	Standard Sugar Caddy	1.25" x 2"	144 ea
4551	Merchandiser Sugar Caddy	1" x 7"	144 ea
4571	8 oz J-Jar	1.5" x 8.5"	144 ea
4900	Slotted Turner	.5" x 2"	144 ea
509	11" Solid Salad Spoon	.25" x 4.5"	144 ea
5109-2	9.5 oz PC Stackable Tumbler	1.25" x 6"	1008 ea
5112-2	12 oz PC Stackable Tumbler	3.5" x 8"	1008 ea
5116-2	16 oz PC Stackable Tumbler	3" x 7.25"	1008 ea
5120	20 oz PC Stackable Tumbler	5.5" x 10"	1008 ea
5212	12 oz Stackable Tumbler	3.5" x 8"	1008 ea
5216	16 oz Stackable Tumbler	3" x 7.25"	1008 ea
5220	20 oz Stackable Tumbler	5.5" x 10"	1008 ea
5224	24 oz Stackable Tumbler	5.5" x 10"	1008 ea
5232	32 oz Tall Stackable Tumbler	5.5" x 8"	1008 ea
5506	9.5 oz Stackable Tumbler	1.25" x 6"	1008 ea
5532	32 oz Stackable Tumbler	4" x 6"	1008 ea
5601 *	1.5 oz Alibi Shot	1.25" x 2.75"	1008 ea
5602 *	2 oz Alibi Shooter	1.25" x 3"	1008 ea
5603 *	3 oz Alibi Shooter/Mini Dessert	1.25" x 3"	1008 ea
5610 *	10 oz Alibi Hi-Ball	Call For Info	1008 ea
5614 *	14 oz Alibi Beverage	Call For Info	1008 ea
5616 *	16 oz Alibi Pint/Mixing	3.25" x 4"	1008 ea
5640 *	8 oz Alibi Champagne Flute	Call For Info	1008 ea
5643 *	8 oz Alibi White Wine	Call For Info	1008 ea
5642 *	20 oz Alibi Red Wine	Call For Info	1008 ea
5810	10 oz Louis Tumbler	.5" x 9.25"	1008 ea
5816	16 oz Louis Tumbler	.75" x 10"	1008 ea
5820	20 oz Louis Tumbler	.63" x 11"	1008 ea
5822	22 oz Louis Tumbler	.75" x 10.25"	1008 ea
5832	32 oz Louis Tumbler	.75" x 12.63"	1008 ea
8004	Diablo Mug	1.5" x 5.5"	144 ea
8505	Rustic Mug	2" x 6.5"	144 ea
PCD796	Dredge (Base only)	2.5" x 5"	144 ea

\*Decorating limited to one color.

# CUSTOM IMPRINTING

## Silk Screening

### Product List B

Lead Time – 6 weeks from approval of sample.  
 Imprint Charge – \$0.50 net each piece, per side, per color.  
 Note: Decorating limited to one color.

Prod No	Description	Max Imprint H x W	Min Order Qty
5544	VersaPour Window Pitcher	2.75" x 2.75"	144 ea
5570	Élan Pitcher	5" x 6"	144 ea
PS501N	Store 'N Pour Pint Complete	1.63" x 10.5"	180 ea
PS502N	Store 'N Pour Pint Backup	1.63" x 10.5"	180 ea
PS601N	Store 'N Pour Quart Complete	4.75" x 10.38"	180 ea
PS601NC	PourPlus Quart Complete	4.75" x 10.38"	180 ea
PS602N	Store 'N Pour Quart Backup	4.75" x 10.38"	180 ea
PS701B	Store 'N Pour Half Gallon Complete	4" x 14.5"	180 ea
PS702	Store 'N Pour Half Gallon Backup	4" x 14.5"	180 ea
PS801B	Store 'N Pour Gallon Complete	4.75" x 18"	180 ea
PS802	Store 'N Pour Gallon Backup	4.75" x 18"	180 ea

## Silk Screening

### Product List C

Lead Time – 6 weeks from approval of sample.  
 Imprint Charge – \$0.75 net each piece, per side, per color.

Prod No	Description	Max Imprint H x W	Min Order Qty
0200	PE 2 qt Bains Marie (below lugs)	2.75" x 3"	360 ea
0205	PPY 2 qt Bains Marie (below lugs)	2.75" x 3"	360 ea
0350	PE 3.5 qt Bains Marie (below lugs)	2" x 16"	360 ea
0355	PPY 3.5 qt Bains Marie (below lugs)	2" x 16"	360 ea
0600	PE 6 qt Bains Marie (below lugs)	5" x 3"	360 ea
0605	PPY 6 qt Bains Marie (below lugs)	5" x 3"	360 ea
0800	PE 8 qt Bains Marie (below lugs)	3.5" x 3.5"	360 ea
0805	PPY 8 qt Bains Marie (below lugs)	3.5" x 3.5"	360 ea
3016 *	16" Round Cork Tray	13" diameter	180 ea
44030	Small Munchie Basket	1.38" x 2.25"	360 ea
44031	Large Munchie Basket	1.38" x 4.5"	360 ea
IG245	Diamond Cut Ice Bucket	2" x 4"	360 ea

\*Decorating limited to one color.

## Silk Screening

### Product List D

Lead Time – 90 days from approval of sample.  
 Imprint Charge – \$0.35 net each piece, per side, per color.

Prod No	Description	Max Imprint H x W	Min Order Qty
43631	15 oz Liberty PC Hurricane	1.75" x 3"	1008 ea
43623	15 oz Liberty PC Pilsner	2.5" x 7.81"	1008 ea
<b>Call For Printing Specifications</b>			
43141	Cup Size PC Measure	—	1200 ea
43142	Pint Size PC Measure	—	1200 ea
43143	Quart Size PC Measure	—	1200 ea
43144	Half Gallon Size PC Measure	—	1200 ea
43145	Gallon Size PC Measure	—	1200 ea



# DURUS® CUSTOM DECORATED DINNERWARE

All Durus items shown on pages 6-7 can be custom decorated.

## Camera-Ready Artwork

- Camera-ready artwork is required for ALL imprinting. Camera-ready art is defined as a sharp black and white image enlarged or reduced to proper size, ready for reproduction. Artwork must be clean with clear, crisp detail. Camera-ready artwork DOES NOT INCLUDE business cards, letterhead, or faxed-in logos. Artwork can also be sent on a CD, USB, or e-mailed (call to get address). Digital artwork must be high resolution 300 dpi in an eps or tiff format. Artwork should be sent in the original format in which it was created. Artwork must also be properly separated when more than one color is used.
- At customer's request, we will prepare camera-ready art at an artist fee of \$100.00/hour.
- Since the design possibilities are governed by the item to be decorated, details of all artwork must be submitted to Carlisle FoodService Products for consideration before an order can be accepted.

## Samples

- With a firm order, we will provide ONE sample for approval before final production.
- A NET charge of \$250.00 must be paid in advance to request one imprint sample without a firm purchase order. This charge also applies if your order is cancelled after receipt of sample, prior to production.



## Minimum Quantities

- Minimum Custom Order – 1,008 per item

## Case Lots

- All orders are sold in full case lots only.

## Lead Time

- 90 days upon approval of sample and date of order entry.

## Terms

- Delivery plus or minus 10% within the quantity ordered constitutes fulfillment of the order and payment shall be made on the basis of actual delivery.

## Returns

- **Custom decorated products are not accepted for exchange or refund.**

## Questions

- Contact your local Carlisle Sales Representative or your Customer Service Representative for more information.

## PERSONALIZED FIBERGLASS TRAYS

All fiberglass trays shown on pages 122-123 can be custom decorated.

### Camera-Ready Artwork

- Any shape or size tray can be made in a custom color or personalized with your logo or artwork.
- Camera-ready artwork is required for ALL imprinting. Camera-ready art is defined as a sharp black and white image enlarged or reduced to proper size, ready for reproduction. Artwork must be clean with clear, crisp detail. Camera-ready artwork DOES NOT INCLUDE business cards, letterhead, or faxed-in logos. Artwork can also be sent on a CD, USB, or e-mailed (call to get address). Digital artwork must be high resolution 300 dpi in an eps or tiff format. Artwork should be sent in the original format in which it was created. Artwork must also be properly separated when more than one color is used.
- Print area extends to .5" from the trays inside edges.
- Artwork colors must be darker than the tray color.

### Samples

- Carlisle must receive written sample approval from customer before order will be produced.
- Requests for more than one sample or for samples without a firm purchase order will be charged \$75.00 net.

### Minimum Quantities

- There is no print charge for minimum orders of 72 each & above.
- There is a 144 pc minimum for custom colors.

### Case Lots

- Orders must be in full case pack quantity.

### Returns

- **Custom colors and decorated products are not accepted for exchange or refund.**

### Delivery

- Custom fiberglass trays ship from our Mexico facility in Chihuahua Mexico.



# HOT STAMPING

## Café & Bistro Trays

Available for Café and Bistro Trays shown on pages 124 & 125.

**Lead Time** – 6 weeks from approval of sample.

**Imprint Charge** – \$.35 net each piece.

**Artwork Charge** – Camera-ready artwork required or a \$100.00 per hour art charge.

**Set-Up Charge** – \$50.00 net per order.

**Plate Charge** – One time charge of \$80.00 net to purchase die on artwork 5"H x 7"W or less.

**Note:** Decorating limited to one color. To provide you the best hot stamp tray possible, the supplied artwork should not have any bold detail. All bold or large wording should be in outline format with the lines no wider than .03 inches.



Prod No	Description	Max Imprint H x W	Min Order Qty
CT1014	14" x 10" Café Tray	5" x 7"	288 ea
CT1216	16" x 12" Café Tray	5" x 7"	288 ea
CT1217	17" x 12" Handled Café Tray	5" x 7"	288 ea
CT1418	18" x 14" Café Tray	5" x 7"	288 ea
CT1713TR	18" x 14" Trapezoid Café Tray	5" x 7"	288 ea
1217BT	12" x 17" Bistro Tray	5" x 7"	288 ea
1319BT	13" x 19" Bistro Tray	5" x 7"	288 ea

## Bronco/TrimLine Waste Containers

Available for Bronco and TrimLine Waste Containers shown on pages 262 & 267.

**Lead Time** – 4 weeks from receipt of approved artwork.

For reorders, please allow 5 working days.

**Imprint Charge** – \$2.00 net each piece, per side.

**Artwork Charge** – One-time art and plate charge ranging up to \$750.00 net.

**Available Ink Colors** – Black, White

### Bronco



Prod No	Description	Max Imprint Shoulder H x W	Max Imprint Belly H x W	Min Order Qty
341010	10 gal Bronco Container	2" x 8"	7.75" x 9.5"	96 ea
341020	20 gal Bronco Container	2.5" x 8"	9" x 8.5"	96 ea
341032	32 gal Bronco Container	7.8 x 9.75"	11.5" x 13.5"	96 ea
341044	44 gal Bronco Container	3.25" x 10"	11.5" x 13.5"	96 ea
341055	55 gal Bronco Container	6" x 13"	14" x 13"	96 ea
345050	50 gal Rolling Container	—	10" x 10"	96 ea
342023	23 gal TrimLine Container	7.5" x 7.75" (Wide Side)	3" x 5.5" (Narrow Side)	96 ea

### TrimLine



# REPLACEMENT PARTS

## Tabletop

Prod No	Description	Pack	Cs Wt/ Cube
<b>Tortilla Servers (page 52)</b>			
0700*	7" Hinged Replacement Lid (0710)	12 ea	3.51/0.27
0703*	8" Replacement Lid (0713)	12 ea	7.00/0.44
0707*	12" Replacement Lid (0717)	6 ea	8.00/0.51
0471	PC Replacement Lid (0470)	24 ea	7.60/0.67
0476	PPY Replacement Lid (0475)	24 ea	6.26/0.65
<b>Cateraide Dual Booster Seat (page 56)</b>			
7112	Replacement Strap	12 ea	2.00/0.43

\*See product page referenced for color availability

## Buffet

Prod No	Description	Pack	Cs Wt/ Cube
<b>Chafer Accessories (pages 82-90)</b>			
607002	Food Pan for 609550, 609576	6 ea	15.00/1.10
607002D	Two-Comp Food Pan for 609550, 609576	6 ea	15.00/1.10
607704	4 qt Inset (fits 6.5" opening) for 609651	6 ea	8.00/0.65
607707	7 qt Inset (fits 8.5" opening) for 609652	6 ea	11.00/1.02
607830EWC	Replacement Cord for 607830EW	1 ea	0.30/0.05
609504	Fuel Holders	1 ea	0.50/0.07
609510C	Dome Cover for 609510	1 ea	5.00/0.67
609510F	6 qt Oval Food Pan for 609510	6 ea	11.00/2.90
609510W	Water Pan for 609510	1 ea	3.00/0.71
609530C	Cover for 609530	1 ea	5.00/0.67

## Buffet Continued

Prod No	Description	Pack	Cs Wt/ Cube
<b>Chafer Accessories (pages 82-90)</b>			
609530F	4 qt Round Food Pan for 609530	6 ea	9.00/0.88
609530W	Water Pan for 609530	1 ea	3.00/0.71
609576LH	Roll-Top Hinge set for 609576	2 ea	0.55/0.02
609576W	Water Pan for 609576	6 ea	05.0/1.06
609578F	Food Pan for 609578	6 ea	19.4/1.36
609578LH	Roll-Top Hinge set for 609578	2 ea	0.35/0.01
609578W	Water Pan for 609578	1 ea	13.8/1.29
609590	Universal Roll-Top Cover	1 ea	12.0/1.70
609600C	Cover for 609600	1 ea	10.00/1.87
609600CS	Screw for 609600 Cover	1 ea	0.05/0.01
609600F	Food Pan for 609600	1 ea	20.00/1.03
609600H	Cover Handle for 609600	1 ea	0.50/1.20
609600HS	Side Handles for 609600	1 ea	0.10/0.01
609600PN	Pivot Nut for 609600 Cover	1 ea	0.05/0.01
609600PNW	Lock Washer Pivot Nut for 609600 Cover	1 ea	0.05/0.01
609600SH	2 Plates for Side Handles for 609600	1 ea	0.30/0.50
609600W	Water Pan for 609600	1 ea	3.00/0.71
609620WH	Water Pan for 609550, 609580	1 ea	1.00/0.30
609720FP	Food Pan for 609720	1 ea	2.00/0.99
609720WP	Water Pan for 609720	1 ea	5.00/1.29
609721FP	Food Pan for 609721	1 ea	3.50/1.03
609721WP	Water Pan for 609721	1 ea	6.00/1.86

## Chafer Replacement Parts Reference Guide

Prod	Clutter Buster	Food Pan	Water Pan	Divided Pan	Cover	Cover Handle	Side Handle	Additional Parts
<b>Chafer (pages 82 &amp; 85)</b>								
609510	609571E	609510F	609510W	609513F	609510C	—	—	—
609530	609523E	609530F	609530W	—	609530C	—	—	—
609550	609571E	607002	609620WH	607002D	609550C	—	—	—
609576	609650E	607002	609576W	607002D	—	—	—	Roll-Top Hinge Set: 609576LH
609578	609650E	609578F	609578W	—	—	—	—	Roll-Top Hinge Set: 609578LH
609600	609650E	609600F	609600W	—	609600C	609600H	609600HS/ 609600SH	Screws for Cover: 609600CS Pivot Nut Cover: 609600PN Lock Washer Pvt Nut Cvr: 609600PNW
609720	609650E	609720FP	609720WP	—	—	—	—	—
609721	609650E	609721FP	609721WP	—	—	—	—	—
<b>Marmites (pages 83 &amp; 84)</b>								
609651	—	607704	—	—	—	—	—	—
609653	—	607707	—	—	—	—	—	—
<b>Urns (pages 82-84)</b>								
609633	—	—	—	—	609801L	609801K	609801H	Faucet: 609801F Faucet Gasket: 609801FG Lid Gasket: 609801LG
609635	—	—	—	—	609801L	609801K	609801H	Faucet: 609801F Faucet Gasket: 609801FG Lid Gasket: 609801LG



## Food Bars & Convenience

Prod No	Description	Pack	Cs Wt/ Cube
<b>Maximizer Food Bar (page 100)</b>			
7749	Sneeze Guard End Shield	1 ea	42.70/16.60
7750	Sneeze Guard Side Shield	1 ea	42.70/16.60
7752	Post Knob	1 ea	0.20/0.04
7753	Shield Knob	1 ea	0.20/0.04
7754*	Basin Divider	1 ea	2.55/0.37
7760*	Sneeze Guard Post	1 ea	8.85/2.99
7761*	Sneeze Guard Cap	1 ea	5.85/2.33
7756	6 ft Shield Support Rod	1 ea	2.60/0.52
7755	Latch Assembly	1 ea	0.35/0.04
IC225CSB	5" Non-marking Swivel Caster with Brake	1 ea	2.15/0.12
<b>Six Star &amp; Five Star Food Bars (pages 101 &amp; 102)</b>			
6676	4 ft Side Shield (42.5"x18.5") - catalog version, NSF approved	1 ea	10.63/3.15
6677	4 ft Side Shield (42.5"x18.5") - version not in catalog, not NSF	1 ea	10.35/1.26
6678	6 ft Side Shield (68.25"x18.5") - catalog version, NSF approved	1 ea	15.25/1.85
6679	6 ft Side Shield (68.25"x18.5") - version not in catalog, not NSF	1 ea	17.00/2.08
6682	End Post Shields (20.75" x 8") - in catalog, NSF approved	1 ea	6.47/0.82
6695	4 ft Ridge Channel	1 ea	3.20/0.13
6696	6 ft Ridge Channel	1 ea	5.15/0.21
6616*	Storage Kit for 6 ft Food Bar	1 ea	26.85/1.81
6602	4 ft Basin (Black only)	1 ea	55.00/13.98
6603*	6 ft Basin	1 ea	55.00/13.98

\*See product page referenced for color availability

Prod No	Description	Pack	Cs Wt/ Cube
<b>Six Star &amp; Five Star Food Bars Cont (page s 101 &amp; 102)</b>			
6686*	6 ft Door	1 ea	6.45/1.91
6687*	Standard Food Bar Leg	1 ea	11.25/4.17
6688*	Youth Food Bar Leg	1 ea	9.00/2.51
6693	Faucet Assembly	1 ea	0.60/0.05
IC225CR	5" Non-marking Caster Fixed	1 ea	2.15/0.12
IC225CSB	5" Non-marking Swivel Caster with Brake	1 ea	2.15/0.12
6697	Tray Slide Bracket - Chrome	1 ea	1.20/0.06
6705	Hardware for Leg/Basin	1 ea	0.60/0.05
6706	Hardware for Sneeze Guard Post	1 ea	0.30/0.05
6707	Hardware for Tray Slides	1 ea	0.30/0.05
6708	Hardware for End Shelf	1 ea	0.30/0.05
6709	Tabletop Drain Plug Assembly	1 ea	0.15/0.05
6672**	4 ft Six-Star Conversion Kit for 2011 NSF Standards	1 ea	25.20/3.15
6673**	6 ft Six-Star Conversion Kit for 2011 NSF Standards	1 ea	34.43/1.71
IC225CSB	5" Non-marking Swivel Caster with Brake	1 ea	2.15/0.12
6697	Tray Slide Bracket - Chrome	1 ea	1.20/0.06
6705	Hardware for Leg/Basin	1 ea	0.60/0.05
6706	Hardware for Sneeze Guard Post	1 ea	0.30/0.05
6707	Hardware for Tray Slides	1 ea	0.30/0.05
6708	Hardware for End Shelf	1 ea	0.30/0.05
6709	Tabletop Drain Plug Assembly	1 ea	0.15/0.05
6672**	4 ft Six-Star Conversion Kit for 2011 NSF Standards	1 ea	25.20/3.15
6673**	6 ft Six-Star Conversion Kit for 2011 NSF Standards	1 ea	34.43/1.71

\*See product page referenced for color availability

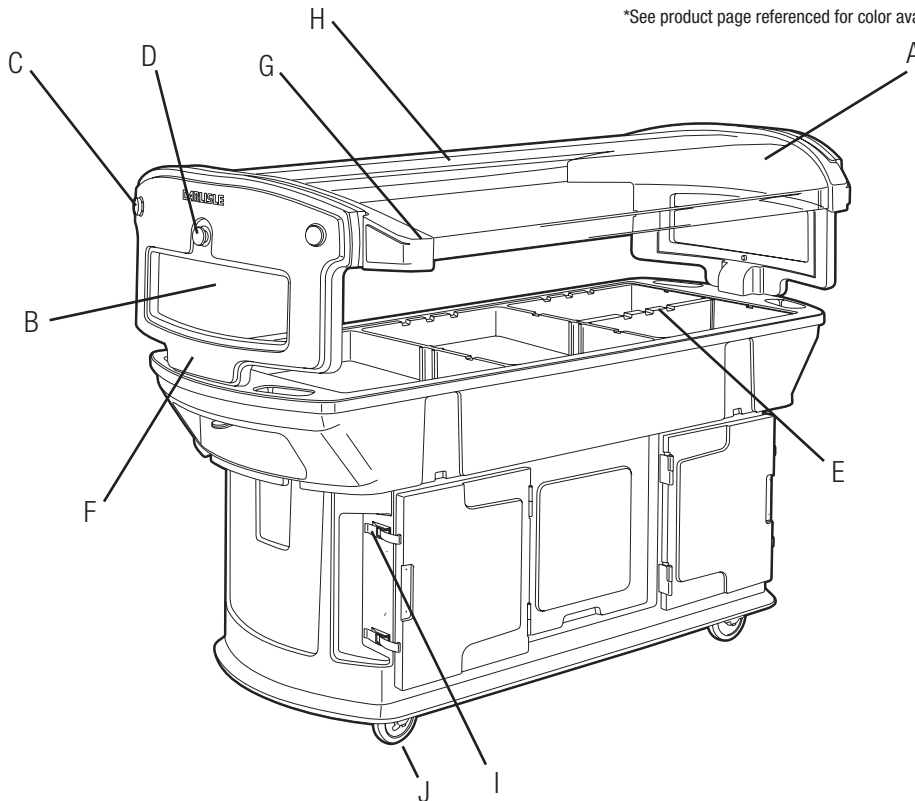

### MAXIMIZER™ FOOD BAR

A	7750	Sneeze Guard Shield
B	7751	End Post Shield
C	7752	Post Knob
D	7753	Shield Knob
E	7754	Basin Divider
F	7760	Sneeze Guard Post
G	7761	Sneeze Guard Cap
H	7756	6 ft Shield Support Rod
I	7755	Latch Assembly
J	IC225CSB	5" Non-marking Swivel Caster with Brake

# REPLACEMENT PARTS

## Food Bars & Convenience Cont

Prod No	Description	Pack	Cs Wt/ Cube
<b>Sneeze Guard Acrylic Shields (page 102)</b>			
9325	Shield - 24" (.19" Acrylic)	1 ea	7.70/1.78
9345	Shield - 48" (.19" Acrylic)	1 ea	14.75/3.00
9365	Shield - 60" (.19" Acrylic)	1 ea	19.80/4.34
9375	Shield - 73.38" (.19" Acrylic)	1 ea	22.30/4.50
<b>Standard Sneeze Guards (page 102)</b>			
9547*	1" Spar - 48"	1 ea	1.80/1.36
9561*	1" Spar - 60"	1 ea	2.60/0.46
9573*	1" Spar - 73.38"	1 ea	2.75/0.56
9848	Legs (only) - Standard-Single Sided	1 pr	3.40/0.98
9850	Legs (only) - Standard-Double Sided	1 pr	5.00/1.10
9645**	4 ft Ridge Channel	1 ea	2.16/0.36
9675**	6 ft Ridge Channel	1 ea	3.51/0.56
<b>Adjustable Sneeze Guards (page 102)</b>			
9648	1.25" Spar - 48" - Bottom - Adj.	1 ea	1.70/0.36
9660	1.25" Spar - 60" - Bottom - Adj.	1 ea	2.75/0.46
9672	1.25" Spar - 73.25" - Bottom - Adj.	1 ea	3.10/0.56
9948	Legs (only) - Adjustable-Single Sided	1 pr	7.00/0.94
9851	Legs (only) - Adjustable-Double Sided	1 pr	5.75/1.10
7702	Hardware for Single-Sided Sneeze Guard	1 ea	0.15/0.05
7704	Hardware for Two-Sided Tabletop Sneeze Guard	1 ea	0.15/0.05
<b>Sneeze Guard Assembly Blocks (see images below) (page 102)</b>			
9001	Assembly Block - 1" 30° 2 Prong	1 pr	0.30/0.05
9005	Assembly Block - 1" 60° 3 Prong	1 pr	0.55/0.10
9002	Assembly Block - 1" 90° 3 Prong	1 pr	0.40/0.05
9003	Assembly Block - 1.25" 90° 3 Prong	1 pr	0.50/0.05
9004	Assembly Block - 1" 90° 2 Prong	1 pr	0.20/0.05
<b>Electric Kettles (page 102)</b>			
0588C	Kettle Replacement Cord	1 ea	0.30/0.05
0588I	10.5 qt Insert	1 ea	2.13/1.14
0588K	Kettle Knob	1 ea	0.10/0.01
0588L	Kettle Hinged Lid	1 ea	4.00/0.35
<b>Crocks (pages 96 &amp; 97)</b>			
0311	Lid - 1.2/0.6 qt (fits 0300, 0301, 0341)	12 ea	0.60/0.09
0202	Lid - 1.5/2.7 qt (fits 0302, 0316, 0342, 0343)	12 ea	1.26/0.12
0602	Lid - 4 qt (fits 0304)	12 ea	2.00/0.21
7038	Gourmet Crock Replacement Lid	12 ea	1.30/0.22

\*See product page referenced for color availability

Prod No	Description	Pack	Cs Wt/ Cube
<b>Cup &amp; Lid Dispensers/Organizers (pages 106 &amp; 107)</b>			
38800MB	Quick Release Mounting Bracket	1 ea	0.20/0.01
38820CL	Lid for 38820 Small Cup Dispenser	1 ea	0.10/0.01
38830CL	Lid for 38830 Large Cup Dispenser	1 ea	0.12/0.01
38G850-SM	Small Release Gasket for Adjustable Drink Cup Dispensers	1 ea	0.25/0.02
38G850-MD	Medium Release Gasket for Adjustable Drink Cup Dispensers	1 ea	0.25/0.02
38G850-LG	Large Release Gasket for Adjustable Drink Cup Dispensers	1 ea	0.25/0.02
38G850-XLG	X-Large Release Gasket for Adjustable Drink Cup Dispensers	1 ea	0.25/0.02
38700P	Pint insert for 38800GLC Lid & Condiment Organizer	1 ea	1.20/0.16
38700Q	Quart insert for 38800GLC Lid & Condiment Organizer	1 ea	2.20/0.23
0311	Lid - 1.2/0.6 qt (fits 0300, 0301, 0341)	12 ea	0.60/0.09
0202	Lid - 1.5/2.7 qt (fits 0302, 0316, 0342, 0343)	12 ea	1.26/0.12
0602	Lid - 4 qt (fits 0304)	12 ea	2.00/0.21
7038	Gourmet Crock Replacement Lid	12 ea	1.30/0.22
<b>Beverage Dispensers (page 100)</b>			
10860*	Lid for PC & PPY TrimLine Dispensers	1 ea	1.04/0.35
10861*	Drip Tray for PC & PPY TrimLine Dispenser	1 ea	0.35/0.05
10864	PPY Translucent TrimLine Reservoir	1 ea	3.30/1.59
10865	PC Clear TrimLine Reservoir	1 ea	3.50/1.59
10866*	PC Single TrimLine Base	1 ea	3.60/1.45
10867*	PC Double TrimLine Base	1 ea	4.20/1.45
10868*	PPY Single TrimLine Base	1 ea	2.80/1.45
10869*	PPY Double TrimLine Base	1 ea	3.60/1.45
2213	Premium TrimLine Faucet	1 ea	0.50/0.05
2212	Economy Faucet (for use with TrimLine, Square, and Round Beverage Dispensers)	1 ea	0.47/0.05
1253	Lid for 3 gal & 5 gal Round Dispensers	1 ea	0.92/0.27
2210	5 gal Round (PE) Dispenser	1 ea	3.45/1.65
2220	3 gal Round (PE) Dispenser	1 ea	2.65/1.06
2209	5 gal Round (PPY) Dispenser	1 ea	3.45/1.65
2219	3 gal Round (PPY) Dispenser	1 ea	2.65/1.06
2211	Round (PE) Dispenser Base	1 ea	2.25/0.70

\*See product page referenced for color availability

Shipping Note: 6616, 667, 6679 can ship UPS/FedEx Ground at oversize cost

**Five Star Food Bar Owners:** For replacement and upgrade parts, contact your Carlisle Customer Service Representative

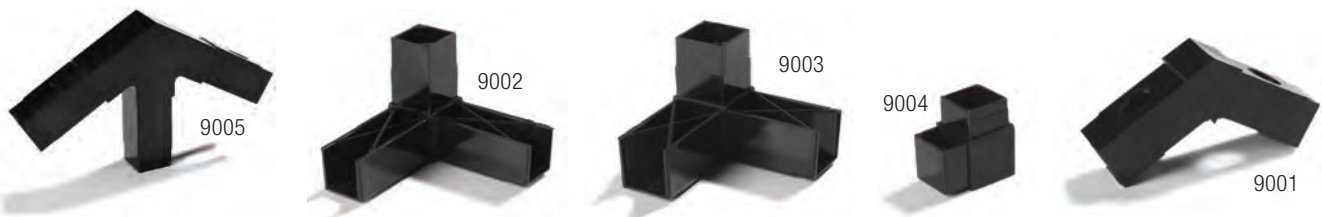

## Food Bars & Convenience Cont

Prod No	Description	Pack	Cs Wt/ Cube
<b>Stainless Steel Dispensers (page 105)</b>			
38132	SS & Acrylic Hinged Lid for Fountain Jars	1 ea	0.30/0.02
38550R	SS Pump with Dip Tube & 2 Sparta Pump Brushes	1 ea	2.00/0.10
38508	2.5 qt Fountain Jar	1 ea	1.00/0.25
38600CL	Standard 2 qt Storage Container with SS Cover and No Pump	1 ea	0.10/0.14
38600IP	Freezable Large Ice Pack	1 ea	2.15/0.05
386010C	SS Cover for 386010 (for use with SS Pump)	1 ea	0.65/0.02
386020C	SS Cover for 386230IB (for use with SS Pump)	1 ea	0.65/0.02
38623INS	Insulation Panel Set for Insulated Dispensers	1 set	0.50/0.01
38550CAP	Plunger Cap for SS Pump 38550R	1 ea	0.02/0.01
38550CL-1	.5 oz Restrictor Clip for SS Pump 38550R	1 ea	0.01/0.01
38550CL-2	1 oz Restrictor Clip for SS Pump 38550R	1 ea	0.01/0.01
38550COR	Cylinder O-Ring for SS Pump 38550R	1 ea	0.01/0.01
38550GB	Rubber Spout Grommet for use with all SS Pump(38550R) Covers	1 ea	0.01/0.01
38550SC	Stainless Wire Spout Clip for SS Pump 38550R	1 ea	0.01/0.01
38550SOR	Spout O-Ring for SS Pump 38550R	1 ea	0.01/0.01
38559CSB	SS Ball Cock for SS Pump 38550R	1 ea	0.01/0.01
38550PSO	Piston Seal & O-Ring for SS Pump 38550R	1 ea	0.10/0.01
38550SPR	SS Spring for SS Pump 38550R	1 ea	0.05/0.01
40155	15" Spout Brush (.5" dia) for SS Pump 38550R	12 ea	0.46/0.11
40156	10.5" Plunger Brush (1.5" dia) for SS Pump 38550R	12 ea	0.85/0.11
<b>Fixed Dispensers (page 105)</b>			
38601C	SS Cover for High Volume Dispensers using Fixed Pump 38600R	1 ea	0.65/0.02
38600R	Fixed Nozzle Pump with Trim-to-Fit Dip Tube	1 ea	0.45/0.13
3861089R	Fixed Nozzle Pump & 89mm Lid with 9" Dip Tube (fits Store 'N Pour)	1 ea	0.50/0.13
38600DT-11	11" Trim-to-Fit Dip Tube for Fixed Pump 38600R	1 ea	0.75/0.07
<b>Standard Dispensers (page 95)</b>			
3831089P	Standard Pump & 89mm Lid with 5" Dip Tube (fits Store 'N Pour)	12 ea	0.45/0.05
CM1035	Standard Pump Only	2 ea	0.75/0.27
38620C	SS Dispenser Cover for use with Standard Pump CM1035	1 ea	1.00/0.01
38600IP	Freezable Large Ice Pack	1 ea	20.15/0.05
38508	2.5 qt Fountain Jar	1 ea	1.00/0.25
38623INS	Insulation Panel Set for Insulated Dispensers	1 set	0.50/0.01
38600CL	Standard 2 qt Storage Container with SS Cover and No Pump	1 ea	0.10/0.14

Prod No	Description	Pack	Cs Wt/ Cube
<b>Maxi Pumps (page 95)</b>			
CM1037	1 oz Maxi Pump with 2 sizes of Nozzle Restrictors	2 ea	1.00/0.27
38400LFV	Lower Flap Valve for Maxi Pump CM1037	1 ea	0.10/0.01
38400UFV	Upper Flap Valve for Maxi Pump CM1037	1 ea	0.10/0.01
38400RSS	Spring for Maxi Pump CM1037	1 ea	0.05/0.01
<b>Pump Kits (page 104)</b>			
3831038	Cap Only, 38mm	12 ea	0.10/0.01
3831063	Cap Only, 63mm for Oil/Shortening Containers	12 ea	0.45/0.16
3831089	Cap Only, 89mm	12 ea	0.45/0.05
38310105	Cap Only, 105mm	12 ea	0.75/0.11
38310110	Cap Only, 110mm	12 ea	0.70/0.09
38310110S	Cap Only, 110mm Snap-Fit Cap	12 ea	1.10/0.09
38310120	Cap Only, 120mm	12 ea	0.85/0.12
38310160	Cap Only, 160mm Snap-Fit Cap for #10 Cans	1 ea	0.35/0.13
<b>Packet Racks (page 104)</b>			
381101LG	3.5 qt Container for 381106 & 381109	12 ea	10.00/2.41
381201LG	4 qt Container for 381206LG	12 ea	6.35/1.01
<b>Classic™ Crock Condiment Station (page 97)</b>			
0302*	2.7 qt Classic™ Crock with Lid	6 ea	7.10/1.25
0204	2.7 qt Lid with Hole for Pump	12 ea	1.26/0.12

\*See product page referenced for color availability

# REPLACEMENT PARTS

## Bar Supplies

Prod No	Description	Pack	Cs Wt/ Cube
<b>Maximizer Portable Bar (page 110 &amp; 111)</b>			
7551*	Front Replacement Bar Panel	1 ea	15.08/1.02
7552*	Side Replacement Bar Panel	1 ea	7.04/0.69
7547	Bar Top Replacement	1 ea	122.00/5.64
7549	Bar Cutting Board Replacement	1 ea	3.57/0.50
7543	Bar Stanchion Replacement	1 ea	14.53/0.22
7546	Bar Drain Assembly Replacement	1 ea	0.15/0.05
7545	Dust Cover for Ice Bin	1 ea	14.53/0.84
7548	Speed Rail	1 ea	5.00/1.33
1568	8 qt Waste Bucket	12 ea	14.72/2.05
IC2254CS	5" Swivel Caster Wheel without Brake	1 ea	2.15/0.12
IC225CSB	5" Swivel Caster Wheel with Brake	1 ea	2.15/0.12
<b>Store 'N Pour (page 112 &amp; 113)</b>			
PS103	Spouts, Specify Color	12 ea	0.45/0.05
PS103AT	Spout Assortment, 2 ea Color	12 ea	1.00/0.05
PS304	Caps, Specify Color	12 ea	0.70/0.10
PS304AT	Caps, Assortment, 2 ea Color	12 ea	0.70/0.10
PS203	Necks	12 ea	1.60/0.30
PS603N	Quart, Container Only	12 ea	3.00/0.85
<b>Deluxe Condiment Caddy system (page 114)</b>			
CHI4	Replacement 1.5 Pt Containers, White	16 ea	2.00/0.77
CHI6	Replacement Pint Containers, White	24 ea	1.99/0.61
SS107	Replacement 1.25 Pt Containers/Lid, White	12 ea	3.16/0.50
<b>Stainless Steel Iced Condiment Caddies (page 114)</b>			
38700IP	Small Freezable Ice Pack	1 ea	0.55/0.04
38700P	Pint Insert, Plastic	12 ea	1.20/0.16
38700Q	Quart Insert, Plastic	12 ea	2.20/0.23
<b>Glass Rimmers (page 116)</b>			
GR09RS	5.5" D Sponges for 3-Tier Unit	12 ea	0.45/0.15

\*See product page referenced for color availability

## Foodservice Trays

Prod No	Description	Pack	Cs Wt/ Cube
<b>Cork Trays (page 126)</b>			
3054	Cork for 14" Round	12 ea	2.22/0.37
3056	Cork for 16" Round	12 ea	2.69/0.37
3019	Cork for 19" x 24" Oval	12 ea	4.56/0.93
3023	Cork for 23" x 28" Oval	12 ea	7.82/1.29
<b>Tray Stands (page 126)</b>			
C3630RS	Replacement Strap for C3630W	2 ea	0.30/0.05

## Catering Equipment

Prod No	Description	Pack	Cs Wt/ Cube
<b>Cateraides (page 134-140)</b>			
XT2550*	Lid Assembly (XT2500, XT5000)	1 ea	2.54/0.56
XT1468L*	Lid Assembly (XT1400, XCT1600, XT1800)	1 ea	4.70/1.09
XT10001LG*	Lid Assembly (XT10000)	1 ea	4.70/5.67
XT10001GA	Gasket (XT10000)	1 ea	2.54/0.56
XT2550LA	Latch Assembly with Screws (XT2500, XT5000, XT10000)	1 ea	0.50/0.05
XT2550GA	O-Ring Gasket (XT2500, XT5000)	1 ea	0.25/0.05
XB35GA	Gasket (XB5, XB3)	1 ea	0.25/0.05
XB35LG	Lid Assembly (XB5, XB3)	1 ea	4.07/0.56
LD111VC	White Vent Cap (LD and XT Beverage Servers)	1 ea	0.15/0.05
LD112VC	White/Black Vent Cap (LD and XT Beverage Servers)	1 ea	0.15/0.05
LD222NLA	Nylex Latch Assembly (LD Beverage Servers, PC Pan Carriers and Ice Caddies)	1 ea	0.05/0.01
LD222LA	Latch Assembly (LD Beverage Servers)	1 ea	0.07/0.01
LD333FA	Faucet Assembly	1 ea	0.50/0.05
IC225FD	Faucet Drain Assembly (IC220, IC2250, IC2250T, IC2254)	1 ea	2.00/0.38
LD236LG*	Lid Assembly (LD250N)	1 ea	2.00/0.35
LD235LG*	Lid Assembly (LD350N, LD500N)	1 ea	2.00/0.46
LD1001LG*	Lid Assembly (LD1000N)	1 ea	4.70/1.14
PC146LG*	Lid Assembly (PC140N, PC160N, PC188N)	1 ea	5.00/1.09
PC181LG*	Lid Assembly (PC180N)	1 ea	5.30/1.41
PC301LG*	Door Assembly (PC300N, PC600N)	1 ea	5.50/1.46
IC225LH*	Lid Assembly (IC2250, IC2250T, IC2254)	1 ea	9.10/1.34
PC146GA	Gasket (PC140N, PC160N, PC188N, PC200N)	1 ea	0.50/0.05
PC181GA	Gasket (PC180N)	1 ea	0.50/0.05
PC301GA	Gasket (PC300N, PC600N)	1 ea	0.50/0.05
LD235GA	Gasket (LD250N, LD350N, LD500N)	1 ea	0.25/0.05
TC1826GA	Gasket (TC1826N)	1 ea	0.45/0.05
LD1001GA	Gasket (LD1000N)	1 ea	0.45/0.05
LD501BD	6 Imprinted Beverage Decals	1 ea	0.15/0.05
PC301HA	Hinge Assembly (PC200N, PC300N, PC600N, TC1826N)	1 ea	0.45/0.05
IC222LH*	Lid Assembly (IC2220)	1 ea	10.20/1.59
IC2250HA	Hinge Assembly (IC2250, IC2250T, IC2254)	1 ea	0.45/0.05
IC222WH	10" Non-Marking Wheel (IC2220)	1 ea	3.30/0.28
IC225WH	8" Non-Marking Wheel (IC2250T)	1 ea	2.30/0.21
IC225CR	5" Rigid Non-Marking Caster (IC2250, IC2254)	1 ea	2.15/0.12
IC2254CS	5" Swivel Non-Marking Caster (IC2220, IC2250, IC2250T, IC2254)	1 ea	2.15/0.12
IC225CSB	5" Swivel Non-Marking Caster with Brake (IC2220, IC2250, IC2250T, IC2254)	1 ea	2.15/0.12
C2222C	4" Swivel Non-Marking Caster (DL300, DL1826)	1 ea	2.70/0.21

\*See product page referenced for color availability



## Professional Cookware

Prod No	Description	Pack	Cs Wt/ Cube
<b>Dura-Kool Sleeves (pages 141-147)</b>			
60RS-1	4.25" x .75" Dura-Kool Sleeve (fits 7", 8" Fry Pans and Small Pots & Pans)	12 ea	1.00/0.12
60RS-2	5.13" x .75" Dura-Kool Sleeve (fits 10"-12" Fry Pans and Medium Pots & Pans)	12 ea	1.50/0.13
60RS-3	6.13" x 1" Dura-Kool Sleeve (fits 14" Fry Pans and Large Pots & Pans)	12 ea	2.00/0.17

## Warewashing

Prod No	Description	Pack	Cs Wt/ Cube
<b>E-Z Glide Rack Dollies (page 200)</b>			
C2237	Handle for C2236H	1 ea	5.80/1.21
C2222C	Replacement Caster for C2220A & C2222A	1 ea	2.70/0.21
C2222HD	Handle for C2220A & C2222A	1 ea	7.00/3.37
BIN4500	3" Rigid Caster	1 ea	1.70/0.05

## Kitchen Accessories

Prod No	Description	Pack	Cs Wt/ Cube
<b>Heat Lamps Options &amp; Accessories (page 156)</b>			
HLRP5	Standard Socket (Heat Lamp HL7237)	1 ea	0.30/0.05
HLRP11	Flex Socket (Heat Lamp HL8185 & HL8195)	1 ea	0.35/0.05
LRP20	24" Flex Arm (Heat Lamp HL8185)	1 ea	2.03/0.25
601825	18" x 26" Bun Pan (use with HL8) (use with 8100 & 8200 Series Lamps)	12 ea	39.00/1.59
HLA8	16" x 24" Maple Board (use with 8100 & 8200 Series Lamps)	1 ea	18.00/1.19
HLA20	Flexiglow Clamp (use with 8100 & 8200 Series Lamps)	1 ea	1.70/0.22
HLRP999	Ceramic Insulator (Heat Lamp HL7237)	1 ea	0.20/0.05
607002	Food Service Pan (HL7237)	6 ea	15.00/1.03
HLRP6	250 Watt White Bulb in Clear(07)	1 ea	0.60/0.26
HLRP7	250 Watt Red Bulb in Red(05)	1 ea	0.60/0.26
<b>Order Wheels (page 158)</b>			
381CH	Mounting Plate, Ceiling Hung	1 ea	0.25/0.01
382WH	12" Wall Hung Extension & Plate	1 ea	1.00/0.03
383CM	9" Counter Mount Extension & Plate	1 ea	0.90/0.28
384MP99	9" Movable Base Extension	1 ea	0.55/0.01
381SC-OW	Ball & Spring Clip Assembly	12 ea	0.25/0.05
381EX	Extension (for CM, MP, CH, or WH Models) Specify length & type with maximum 24" length	1 ea	0.55/0.00
<b>Spatulas &amp; Paddles (page 170 &amp; 171)</b>			
40361	4.5" x 7" Standard Nylon Replacement Blade	6 ea	1.50/0.10
40362	6.5" x 9" Large Nylon Replacement Blade	6 ea	2.65/0.16

## Transportation

Prod No	Description	Pack	Cs Wt/ Cube
<b>Bussing Carts (page 255)</b>			
CCSTR2036	4" Stem Caster for CC2036, CC2243	1 ea	1.10/0.05
<b>Fold 'N Go Carts (page 254)</b>			
SBCC240	Replacement Caster, Swivel	1 ea	2.15/0.12
SBCC245	Replacement Caster, Swivel with Brake	1 ea	2.15/0.12
<b>Service Cart (page 256)</b>			
IC225CSB	5" Swivel Caster with Brake	1 ea	2.15/0.12
IC2254CS	5" Swivel Caster	1 ea	2.15/0.12
IC225CR	5" Rigid Caster	1 ea	2.15/0.12
<b>Optimizer Dish Dollies (page 258)</b>			
ADDD	ADD4, ADD6 Dividers	2 ea	4.70/0.47
ADSD	ADS4, ADS8 Dividers	4 ea	10.00/1.02
ADDC	ADD4, ADD6 Vinyl Cover	1 ea	2.10/0.31
ADSC	ADS4, ADS8 Vinyl Cover	1 ea	2.10/0.31
IC222WH	10" Wheel for ADD4, ADD6	1 ea	3.30/0.28
IC225CSB	5" Swivel Caster with Brake for All Models	1 ea	2.15/0.12
IC225CR	5" Fixed Casters for ADS4, ADS8	1 ea	2.15/0.12
ADDA	Axle for ADD4, ADD6	1 ea	1.80/0.22

## Storage & Handling

Prod No	Description	Pack	Cs Wt/ Cube
<b>Ingredient Bins (page 188)</b>			
BIN27L	Replacement lid for BIN27	1 ea	4.50/0.64
BIN36L	Replacement lid for BIN36	1 ea	5.65/0.64
BIN44L	Replacement lid for BIN44	1 ea	5.85/0.64
BIN4600	3" Swivel Caster	1 ea	1.70/0.05
BIN4500	3" Rigid Caster	1 ea	1.70/0.05

# DURUS® WARRANTY & CARE

## Durus Dinnerware 4 Year Limited Warranty

Durus Dinnerware is shown on pages 6-9. Durus must be handled like any fine dinnerware. Carlisle FoodService Products agrees to extend a limited four year Warranty against breakage on its Durus line of dinnerware provided that the following procedures for care are observed:

- Do not use steel wool, harsh abrasive pads, abrasives, or scouring compounds, chlorine bleach, or chlorine based solutions in the washing process of this dinnerware. Do not intentionally strike or bang against counters or hard objects to remove debris. All debris should be removed by hand using a nylon or silicone plate scraper, sponge, or soft bristle brush. Do not place Durus dinnerware in a standard oven or microwave oven. Do not expose Durus to direct flame or dry heat over 180°F.
- Upon receipt of your shipment, complete one Warranty Card enclosed with your purchase. If this card is not completely filled out and forwarded to Carlisle FoodService Products, the Warranty is null and void.
- This Warranty herein extends only to the original user (purchaser), and is not assignable, or transferable, and shall not apply to any parts which have been subject to alteration, misuse, negligence, or accident. This Warranty does not cover chipping or staining of the product.
- Should any breakage occur during the limited Warranty, which commences on the date of delivery or receipt, please contact Carlisle's Customer Service Department at 800.654.8210 for return authorization and shipping instructions.



In light of the express four (4) year Limited Warranty provided by Carlisle FoodService Products, the duration of any implied warranties, including any implied warranties of the merchantability of fitness for a particular purpose, is hereby limited in all respects to the period covered for the express Warranty. Except for its Warranty obligations, Carlisle FoodService Products shall not be liable to the purchaser or to any other person, to the maximum extent permitted by law, for any loss or damages of any kind, including but not limited to, incidental, special, or consequential damages or loss of profits, arising out of or in connection with the use, loss of use, or replacement of the warranted products. Misuse, abuse, negligence, or failure to follow the Durus care and use instructions will render this warranty null and void.

### How to Care for your Durus Dinnerware

- Do handle Durus like any fine dinnerware.
- Use only non-abrasive cleaning pads that do not contain any mineral grit as this will scratch the melamine surface, or use any Carlisle plastic bristled brush to remove dried-on food.
- Do pre-soak Durus, if desired with a non-chlorinated presoak.
- Do remove hard water film, food residue, and dried-on stains using a simple paste made from an oxygenating or alkaline presoak powder according to detergent manufacturer's directions.
- Do wash Durus in a good quality, non-chlorinated, highly alkaline dishwashing compound.
- Do not place Durus in a microwave oven.
- Do not place Durus in a conventional oven.
- Do not expose Durus to direct flame or dry heat over 180°F.
- Do not use harsh abrasive cleaner, steel wool, or metal scouring pads.
- Do not use chlorine bleach or chlorine based cleaning/sanitizing solutions.
- Do not overload dishwasher racks.
- Do not strike or bang Durus to remove food debris.

# CARLISLE | DINEX®

As a part of the Carlisle family Carlisle | Dinex is known as a leading manufacturer of traytop ware and disposables for today's healthcare industry. Our complete trayline and meal-delivery equipment systems as well as systems for induction base heating and cook-chill retherm are the best in the industry. For more information on any of these great products or a copy of the Dinex catalog visit us at [www.carlislefsp.com](http://www.carlislefsp.com).



# MARKO

A CARLISLE COMPANY

The best line of easy-care, made-to-measure table linens is just a call or click away. Marko

By Carlisle offers a complete selection of table coverings, skirting, napkins, and more in a huge variety of colors, styles, and fabrics all custom sewn to your specifications, one company is all you need for all of your linens.

Visit Marko at [www.carlislefsp.com](http://www.carlislefsp.com).

# CARLISLE

SANITARY MAINTENANCE PRODUCTS

Did you know that Carlisle manufactures one of the single largest lines of specialty cleaning tools in the world? In addition to our Sparta® brand brushes, the industry standard for foodservice and food processing operations the world over, we make every tool you need to keep your operation sparkling. Visit our online catalog at [www.carlislefsp.com](http://www.carlislefsp.com).



# CARLISLE

FOODSERVICE PRODUCTS

## TERMS &amp; CONDITIONS



### 1. Terms and Method of Payment

- a. All orders are subject to approval and acceptance by SELLER. No order accepted by SELLER shall be subject to cancellation, termination, suspension, change, reduction, cutback or other modification except with SELLER'S prior written consent.
- b. Unless otherwise specified on the sales order or invoice, terms shall be cash with order, letter of confirmed credit, or sight draft attached to bills of lading or other shipping documents at SELLER'S election. Where SELLER has extended credit to BUYER our standard terms of payment shall be .5 of 1% 10 days – net 30 days from invoice date. The amount of terms of credit, if extended, may be changed or credit withdrawn by SELLER at any time. No orders will be shipped on a COD basis.
- c. Prices do not include federal, state or local taxes, duties or other levies, now or hereafter enacted, applicable to the items deliverable under the sales order or invoice (hereinafter called ITEMS), which taxes, duties, or other levies will be added by SELLER to the sales price and will be paid by BUYER unless BUYER provides SELLER with a proper exemption certificate.
- d. Packaging for commercial shipment is included in the contract price. Any special packaging, crating or shipping instructions must be noted on BUYER'S original order and acknowledged by SELLER.

### 2. Title and Delivery

The ITEMS shall be delivered F. O. B. SELLER'S plant, and title thereto shall pass to BUYER, upon SELLER'S delivery of the ITEMS to a common carrier for shipment to BUYER. All items from the Carlisle FoodService Products catalog may be combined to obtain prepaid freight, regardless of the shipping point. Freight is prepaid on all orders totaling \$3,000 net or more to one destination within the contiguous 48 United States. Freight on prepaid International Shipments will be paid on normal ground transportation from shipping point to the consignee. When the order qualifies for prepaid freight, Seller shall have the right to select the means of transportation. If Buyer requires a means of transportation other than the one normally selected by Seller, any extra cost incurred by reason of using such other means shall be paid by Buyer. Palletized international orders requiring heat treated pallets will be charged \$4.25 net per pallet. International orders requiring heat treated certified bark-free pallets will be charged \$18.50 net per pallet. Any accessorial charges incurred because of a customer request will be the responsibility of the requester. Any items backordered from a prepaid shipment will be forwarded prepaid. Items backordered from ex works shipments will be forwarded ex works.

### 3. Inspection and Acceptance

Thoroughly inspect all shipments. Do not accept a damaged or short shipment until exception is noted on the freight bill. BUYER will be held responsible for all shipments with freight bills signed free and clear. If concealed damage is discovered, contact the freight company immediately for inspection. Concealed damage must be reported to the carrier within 7 days of receipt. All damaged goods and shortages that are not properly documented and reported upon receipt become the sole responsibility of the BUYER.

### 4. Patent Indemnification

SELLER shall protect and indemnify BUYER and its directors, officers, agents and employees against all claims for damages or profits, including all reasonable costs incurred by BUYER in connection therewith, arising from infringement of patents, copyrights, trademarks or misappropriation of designs.

### 5. Returns

No returns will be accepted without an authorization number from Carlisle Customer Service. An authorization number may be obtained by calling 800-654-8210 and requesting a Return Authorization from Customer Service. All requests for return must occur within 90 days of the original shipment of the product unless special authorization is obtained. Merchandise returned without authorization will be refused and returned to the customer, freight collect. Any merchandise must be returned freight prepaid, and is subject to a minimum of 15% restocking charge. After 90 days, a 25% restocking fee applies. All returned goods must reference the original invoice and purchase order. Returned goods must be in original standard packs and in unused salable condition. Special Order Products will not be accepted for exchange or return. This includes any articles custom imprinted or modified by purchaser.

### 6. General

- a. All prices are list and subject to change without notice. Orders from authorized accounts will be accepted with the understanding that prices are those in effect at the time of shipment. These prices are exclusive of all sales taxes which may be levied by State, Federal, or City governments.
- b. Orders less than \$50.00 net will be charged a \$10.00 handling fee. The initial order requirement for a new customer is \$3,500 net, and must be accompanied by a tax exemption certificate.
- c. Orders calling for less than a standard case pack will be charged \$3.50 net each per broken case.
- d. All orders of custom products are subject to shipment of plus or minus 10% of the quantity ordered.
- e. No ITEMS to be furnished hereunder shall be exported by BUYER unless SELLER is first notified in writing of the intention to so export and all applicable regulations and licenses are complied with and obtained by BUYER or its customer.
- f. SELLER hereby certifies that the goods described herein of its manufacture will be produced in compliance with all applicable requirements of Sections 6, 7 and 12 of the Fair Labor Standards Act, as amended, and all order of the United States Department of Labor issued under Section 14 thereof. SELLER further certifies that it is in compliance with the Equal Employment Opportunity clause in Section 202, paragraphs 1 through 7 of Executive Order 11246, as amended, relative to equal employment opportunity and the implementing Rules and Regulations of the Office of Federal Contract Compliance.
- g. SELLER is not responsible for typographical errors made in any of its publications or for stenographic or clerical errors made in preparation of quotations, sales orders, acknowledgments, or invoices. All such errors are subject to correction.
- h. This agreement shall be governed by the laws of the state of Oklahoma.
- i. SELLER'S "Terms and Conditions" as set forth above shall govern all transactions. Any inconsistent terms of BUYER wherever set forth and whether oral or written, shall not be binding upon SELLER unless agreed to by SELLER in writing. No waiver or exception to any of the hereinabove enumerated conditions or any of the special terms and provisions relating to any order shall be binding upon SELLER unless agreed to in writing by SELLER.
- j. SELLER reserves the right to change or discontinue the color, design, component content or price of any ITEMS in SELLER'S catalog or published price lists without prior notice at any time.



# PRODUCT INDEX

<b>Prod No</b>	<b>Page No</b>	<b>Prod No</b>	<b>Page No</b>	<b>Prod No</b>	<b>Page No</b>	<b>Prod No</b>	<b>Page No</b>
0120.....	35	0620.....	55	10236U.....	180	10320-8.....	285
0132.....	35	0700.....	53, 298	10237U.....	180	10321.....	180
0200.....	187, 294	0703.....	53, 298	10240.....	180	10321-8.....	285
0202.....	97, 187, 300	0707.....	53, 157, 298	10241.....	180	10332.....	181
0203.....	187	0710.....	53	10250U.....	180	10336U.....	180
0204.....	301	0713.....	53	10256U.....	180	10337U.....	180
0205.....	187, 294	0717.....	53, 157	10257U.....	180	10355.....	180
0240.....	99, 293	0800.....	187, 294	10260.....	180	10400.....	181
0261.....	99	0805.....	187, 294	10260-8.....	285	10401.....	181
0287.....	99	0820.....	47	10261.....	180	10402.....	181
0295.....	99, 293	0830.....	47	10261-8.....	285	10410U.....	181
0296.....	99, 293	0831.....	47	10262.....	180	10411U.....	181
0300.....	97	0843.....	47	10262-8.....	285	10415.....	181
0301.....	97, 293	0844.....	47	10269.....	180	10416U.....	181
0302.....	97, 293, 301	0844-8.....	277	10270U.....	180	10417U.....	181
0304.....	97, 293	0845.....	47	10271U.....	180	10420.....	181
0306.....	97	0845-8.....	277	10272.....	181	10420-8.....	285
0311.....	97, 300	0852.....	47	10275.....	180	10421.....	181
0316.....	97, 293	0855.....	45	10276U.....	180	10421-8.....	285
0333.....	51	0860.....	45	10277U.....	180	10422.....	181
0338.....	47	0862.....	45	10280.....	180	10422-8.....	285
0340.....	75	0864.....	45	10280-8.....	285	10423.....	181
0341.....	97	0873.....	47	10281.....	180	10430U.....	181
0342.....	97	0875.....	47	10281-8.....	285	10431U.....	181
0343.....	97	0878.....	47	10282.....	180	10435.....	181
0344.....	75	1000B.....	67	10282-8.....	285	10436U.....	181
0345.....	25	10145.....	132	10290U.....	180	10437U.....	181
0347.....	25	10200.....	180	10291U.....	180	10440.....	181
0350.....	187, 294	10201.....	180	10292.....	181	10441.....	181
0355.....	187, 294	10202.....	180	10295.....	180	10450U.....	181
0362.....	47	10203.....	180	10296U.....	180	10456U.....	181
0365.....	97, 293	10210U.....	180	1030.....	117	10457U.....	181
0372.....	97, 293	10211U.....	180	1030FMT.....	125	10460.....	181
0386.....	202	10212.....	181	10300.....	180	10460-8.....	285
0411.....	69	10215.....	180	10300-8.....	285	10461.....	181
0470.....	53	10216U.....	180	10301.....	180	10461-8.....	285
0471.....	53, 298	10217U.....	180	10301-8.....	285	10462.....	181
0475.....	53	10220.....	180	10302.....	180	10462-8.....	285
0476.....	53, 298	10220-8.....	285	10302-8.....	285	10469.....	181
0588.....	103, 277	10221.....	180	10302FMT.....	125	10470U.....	181
0588C.....	300	10221-8.....	285	1031.....	117	10471U.....	181
0588I.....	300	10222.....	180	10310U.....	180	10475.....	181
0588K.....	300	10222-8.....	285	10311U.....	180	10476U.....	181
0588L.....	300	10223.....	180	10312.....	181	10477U.....	181
0600.....	187, 294	10230U.....	180	10315.....	180	10480.....	181
0602.....	97, 187, 300	10231U.....	180	10316U.....	180	10480-8.....	285
0603.....	187	10232.....	181	10317U.....	180	10481.....	181
0605.....	187, 294	10235.....	180	10320.....	180	10481-8.....	285

<b>Prod No</b>	<b>Page No</b>	<b>Prod No</b>	<b>Page No</b>	<b>Prod No</b>	<b>Page No</b>	<b>Prod No</b>	<b>Page No</b>
10482.....	181	10631.....	183	10854.....	108	1212DFG.....	123
10482-8.....	285	10632.....	183	10856.....	108	1212FG.....	123
10490U.....	181	10637.....	183	10857.....	108	1212WFG.....	123
10491U.....	181	10640.....	183	10860.....	300	1216LDFG.....	123
10495.....	181	10641.....	183	10861.....	300	1216LFG.....	123
10496U.....	181	10642.....	183	10864.....	300	1216LWFG.....	123
10497U.....	181	10643.....	183	10865.....	300	1217BT.....	125, 297
10500.....	181	10644.....	183	10866.....	300	1218FMT.....	125
10500-8.....	285	10647.....	183	10867.....	300	1219LDFG.....	123
10501.....	181	10648.....	183	10868.....	300	1219LFG.....	123
10501-8.....	285	1071.....	202	10869.....	300	1219LWFG.....	123
10502.....	181	10720.....	185	10880.....	155	1220DFG.....	123
10502-8.....	285	10721.....	185	10881.....	155	1220FG.....	123
10510U.....	181	10722.....	185	10882.....	155	1220WFG.....	123
10511U.....	181	10723.....	185	10883.....	155	1222LDFG.....	123
10515.....	181	10724.....	185	10884.....	155	1222LFG.....	123
10516U.....	181	10725.....	185	10885.....	155	1222LWFG.....	123
10517U.....	181	10726.....	185	10886.....	155	1230FMT.....	125
10520.....	181	10730.....	185	10887.....	155	1250B.....	67
10520-8.....	285	10731.....	185	10888.....	155	1252.....	187
10521.....	181	10732.....	185	10889WC.....	155	1253.....	300
10521-8.....	285	10733.....	185	1089RS.....	129	12875.....	159
10535.....	181	10734.....	185	1089RS1520.....	129	12876.....	159
10536U.....	181	10735.....	185	10897.....	155	12877.....	159
10537U.....	181	10736.....	185	10901.....	155	12881.....	155
10601.....	115	10740.....	185	1100GL.....	127	12882.....	155
10602.....	115	10741.....	185	1100GR.....	127	12886.....	155
10610.....	183	10742.....	185	11000.....	117	12887.....	155
10611.....	183	10761.....	187	11020.....	90	12891.....	155
10611C.....	183	10763.....	187	11026.....	90	12892.....	155
10612.....	183	10764.....	187	11030.....	90	12901.....	155
10612C.....	183	10765.....	187	11036.....	90	1300.....	55
10617.....	183	10766.....	187	1104.....	35	1318DFG.....	123
10617C.....	183	10767.....	187	1105.....	35	1318FG.....	123
10620.....	183	10768.....	187	1108.....	35	1318FMT.....	125
10621.....	183	10769.....	187	1110.....	35	1318WFG.....	123
10621C.....	183	10770.....	187	1110L.....	42	1319BT.....	125, 297
10622.....	183	10771.....	187	1112.....	35	1400GL.....	127
10622C.....	183	10772.....	187	1112L.....	42	1400GR.....	127
10623.....	183	10773.....	187	1116.....	35	1401.....	117
10623C.....	183	10806.....	105	11789.....	155	1410DFG.....	123
10624.....	183	10807.....	105	11799.....	155	1410FG.....	123
10624C.....	183	10820.....	108	11801.....	155	1410GR.....	127
10627.....	183	10828.....	107	11878.....	155	1410WFG.....	123
10627C.....	183	10850.....	108	11879.....	155	1418LDFG.....	123
10628.....	183	10851.....	108	1200.....	187	1418LFG.....	123
10629.....	183	10852.....	108	1202.....	187	1418LWFG.....	123
10630.....	183	10853.....	108	1205.....	187	1418PC.....	125

<b>Prod No</b>	<b>Page No</b>	<b>Prod No</b>	<b>Page No</b>	<b>Prod No</b>	<b>Page No</b>	<b>Prod No</b>	<b>Page No</b>
1419DFG	123	2209	108, 300	3042	113	341010ICE	159, 263
1419FG	123	2210	108, 300	3054	302	341011	159, 263, 288
1419WFG	123	2211	300	3056	302	341020	263, 297
1520LDFG	123	2212	300	3100GR	127	341020REC	271
1520LFG	123	2213	300	3210	115	341021	263, 288
1520LWFG	123	2214DFG	123	3211	115	341021REC	271
1532	185	2214FG	123	3253GR	127	341032	263, 297
1544	185	2214WFG	123	33000	11	341032REC	271
1556	185	2216DFG	123	33002	11	341033	263, 288
1568	185, 302	2216FG	123	33004	11	341033REC	271
1600GL	127	2216GR	127	33006	11	341034	263
1600GR	127	2216WFG	123	33008	11	341035	263
1612DFG	123	2219	108, 300	33010	11	341044	263, 297
1612FG	123	2220	108, 300	33012	11	341044REC	271
1612GR	127	2227	108	33016	11	341045	263, 288
1612WFG	123	2229	108	33018	11	341045REC	271
1629	185	2230	108	33020	11	341055	263, 297
1713DFG	123	2310DFG	123	33024	11	341056	263, 288
1713FG	123	2310FG	123	33030	11	341057	263
1713WFG	123	2310WFG	123	33032	11	341132	263
1800	187	2419	127	33034	11	341144	263
1805	187	2500	47	33036	11	341528	264
1814DFG	123	2500GR	127	33038	11	341529	264
1814FG	123	2512	80	33040	11	341540	264
1814GR	127	2618DFG	123	33042	11	341541	264
1814WFG	123	2618FG	123	33050	11	341542	264
1826DFG	123	2618FMT	125	33080	11	342015	267
1826FG	123	2618WFG	123	33082	11	342015REC	271
1826GR	127	2637DFG	123	33086	11	342023	267, 297
1826WG	123	2637FG	123	3312	49	342023CMP	271
1900	27	2637WFG	123	3316	49	342023REC	271
1960	27	269DFG	123	3319	49	342024	267
1965	27	269FG	123	33302	61	342025	267, 271
1987	27	269FMT	125	33310	61	342026REC	271
1989	27	269WFG	123	33312	61	342027REC	271
1991	27	2700GR	127	33314	61	342913	269
1992	27	2710	188	33316	61	342913REC	271
1993	27	2823	127	33318	61	342915	269
1994	27	3004	80	33320	61	342927	269
2015DFG	123	3013	127	33322	61	342928	269
2015FG	123	3014	127	33324	61	342928REC	271
2015GR	127	3015	127	33326	61	342940	269
2015WFG	123	3016	127, 294	33360	59	342941	269
2115DFG	123	3019	302	33362	59	342941REC	271
2115FG	123	3020	117	33364	59	343021	266
2115WFG	123	3020-8	279	339	75	343021REC	271
2200	187	3022	117	34RECLBL	271	343022	266, 271
2205	187	3023	302	341010	263, 297	343122	266

<b>Prod No</b>	<b>Page No</b>	<b>Prod No</b>	<b>Page No</b>	<b>Prod No</b>	<b>Page No</b>	<b>Prod No</b>	<b>Page No</b>
343123.....	266	362208P24.....	227, 251	366918.....	231	369413B.....	243
343124.....	266	36232.....	250	366922.....	231	369418B.....	241
343523.....	266	36233.....	250	367016TC.....	223	369419B.....	243
343523REC.....	271	36236.....	225	3672231.....	263	36942.....	249
343525.....	266	36270.....	163	367618.....	227, 251	369420.....	243
343526REC.....	271	362723.....	163	367624.....	227, 251	369424B.....	241
343527REC.....	271	362743.....	163	367814.....	231, 252	369425B.....	243
343935.....	266	36275.....	229, 251	367818.....	231, 252	36943.....	249
343935REC.....	271	36292.....	229, 251	3682.....	225	369430.....	241
343936REC.....	271	36324C.....	233	36859.....	223, 251	36944.....	249
343937REC.....	271	3633.....	250	36860.....	223, 251	369442B.....	241
343950.....	266	3633019.....	239	36861.....	223	369448B.....	241
343950REC.....	271	3633118.....	239	36863.....	223, 251	36945.....	249
343951.....	266	3633124.....	239	36864.....	223, 251	369454B.....	241
344042.....	264	3633136.....	239	36865.....	223	369460.....	241
344056.....	264	3633218.....	239	36867.....	223	36947.....	249
344056REC.....	271	3633224.....	239	36868.....	223	369472B.....	241
344057.....	264	3633519.....	239	36883.....	223, 251	369475.....	246
344057REC.....	271	3633525.....	239	36884.....	223, 251	369478B.....	241
344058.....	264	3633537.....	239	36885.....	223, 291	369484B.....	241
345050.....	264, 297	36336C.....	233	36900.....	249	36949.....	249
345050REC.....	271	3633670.....	239	369016C.....	245	369520.....	243
346144.....	269	3638831.....	287	369016R.....	245	369550B.....	243
346145.....	269	36399.....	225, 287	369024C.....	245	369551B.....	243
346146.....	269	36400.....	225, 287	369024R.....	245	369552B.....	243
356.....	51	364105.....	239	36903.....	249	369595.....	246
36P5.....	250	36439.....	250	369032C.....	245	369670B.....	243
360714B.....	243	3647248.....	239	36904.....	247, 287	369674B.....	243
36141003-1.....	225, 287	3647524.....	239	36905.....	247, 287	36968.....	246
361415.....	225	3647536.....	239	36906D.....	247, 287	36970.....	246
361416.....	225, 287	3647548.....	239	36906DW.....	247, 287	369724.....	245
361437.....	225	36490.....	239	369066B.....	245	369732.....	245
36175.....	229, 251	36490R.....	239	369070B.....	245	369811B.....	245
36190.....	229, 251	365300.....	229, 251, 287	369074B.....	245	369814B.....	245
36192.....	229, 251	365310.....	229, 251, 287	36908.....	247, 287	369816B.....	245
36193.....	229, 251	365320.....	229, 251	36908C.....	247, 260	369817B.....	245
36197.....	229, 251	365351.....	229	36908W.....	247	369819B.....	245
362013.....	239	365408.....	235	369082.....	245	369820B.....	245
3620194.....	237	36567.....	233, 252	36909.....	249, 287	369824B.....	245
3620294.....	237	36568.....	233, 252	36910.....	263	369832.....	245
36204818.....	227, 251	36592.....	233	36911.....	263	36990.....	245
36204824.....	227, 251	36596.....	233	36917.....	263	36990R.....	245
36207218.....	227, 251	366318.....	231, 252	36920-1.....	267	3753DFG.....	123
36207224.....	227, 251	366324.....	231, 252	369365.....	246	3753FG.....	123
36219618.....	227, 288	36633.....	225	369375.....	246	3753WFG.....	123
36219624.....	227, 288	366330.....	231, 252	36940.....	249	38G850-LG.....	300
36219663.....	229, 287	366530.....	231, 252	36941.....	249	38G850-MD.....	300
362208P18.....	227, 251	366824.....	231, 252	369412B.....	241	38G850-SM.....	300



<b>Prod No</b>	<b>Page No</b>	<b>Prod No</b>	<b>Page No</b>	<b>Prod No</b>	<b>Page No</b>	<b>Prod No</b>	<b>Page No</b>
38G850-XLG.....	300	38550CL-2.....	301	3970.....	167	40237.....	249
381CH.....	303	38550COR.....	301	3971.....	167	40261.....	237
381EX.....	303	38550GB.....	301	3980.....	167	40262.....	237
381SC-OW.....	303	38550PSO.....	301	3981.....	167	40267.....	237
381101LG.....	301	38550R.....	301	3990.....	167	40271.....	237
381109LG.....	105	38550SC.....	301	3991.....	167	40275.....	237
3812CH.....	159	38550SOR.....	301	3992.....	167	4029.....	35
3812CM.....	159	38550SPR.....	301	3993.....	167	40290.....	290
3812MP.....	159	38559CSB.....	301	40000.....	290	40300.....	245
381201LG.....	301	38600CL.....	301	40020.....	290	40301.....	245
381206LG.....	105	38600DT-11.....	301	40021.....	287	40305.....	245
38132.....	301	38600IP.....	301	40025.....	290	40306.....	245
3816CH.....	159	38600R.....	95, 301	4006.....	99	4033.....	37
3816MP.....	159	38601.....	105	40075.....	233, 252	4034.....	37
3816WH.....	159	38601C.....	301	40076.....	233, 252	40340.....	246
38180A.....	159	386010.....	105	40077.....	233, 252	40345.....	245
382WH.....	303	386010C.....	301	40078.....	233	40347.....	171
3820CH.....	159	386020C.....	301	4008.....	35	40349.....	171
3820MP.....	159	3861089R.....	301	40081.....	231, 252	4035.....	37
38240A.....	159	38620C.....	301	40082.....	231, 252, 291	40350.....	171
383CM.....	303	38623IB.....	105	40083.....	231, 252	40351.....	171
38310.....	105, 279	38623INS.....	301	4009.....	99, 293	40352.....	171
38310105.....	301	386230IB.....	105	4010.....	35	40353.....	171
38310110.....	301	38655.....	95	40107.....	231	40354.....	171
38310110S.....	301	38700IP.....	302	40108.....	231	40355.....	171
38310120.....	301	38700P.....	300, 302	40109.....	231	40356.....	171
38310160.....	301	38700Q.....	300, 302	40111.....	290	40359.....	171
3831038.....	301	38704C.....	115	4012.....	35	40361.....	171, 303
3831063.....	301	38704CNS.....	115	40140.....	250, 290	40362.....	303
3831089.....	301	38704CSIB.....	115	40144.....	249, 291	40370.....	161
3831089P.....	301	38705C.....	115	40146.....	249, 252, 291	40371.....	161
38322BH.....	115	38706C.....	115	40147.....	249, 252	40372.....	161
38332BH.....	115	38800GLC.....	107	40148.....	249	40373.....	161
38342BH.....	115	38800MB.....	300	40155.....	301	40374.....	161
38360.....	159	38820C.....	107	40156.....	301	4037400.....	290
38360A.....	159	38820CL.....	300	4016.....	35	40375.....	161
384MP99.....	303	38830C.....	107	40164.....	163, 290	40376.....	161
38400LFV.....	301	38830CL.....	300	40165.....	163	40377.....	161
38400RSS.....	301	38850GEW.....	107	4020.....	35	40378.....	161
38400UFV.....	301	388804L.....	107	40210.....	235	40379.....	161
38480.....	159	38882G.....	107	40220.....	235	40380.....	161
38480A.....	159	38883G.....	107	40224.....	235, 288	40390.....	163
38502.....	105	38884G.....	107	40225.....	235	40391.....	163
38503.....	105	3956.....	167	40227.....	235	40392.....	163
38504.....	105	3957.....	167	40230.....	235	40393.....	163
38508.....	301	3958.....	167	40232.....	235	40394.....	163
38550CAP.....	301	3960.....	167	40233.....	235	40395.....	161
38550CL-1.....	301	3961.....	167	40236.....	249, 291	40396.....	161

<b>Prod No</b>	<b>Page No</b>	<b>Prod No</b>	<b>Page No</b>	<b>Prod No</b>	<b>Page No</b>	<b>Prod No</b>	<b>Page No</b>
40397.....	161	4109.....	99, 293	43034.....	7	43512.....	15
40398.....	161	41093.....	249, 252	43036.....	7	43514.....	15
40399.....	161	4112.....	99, 293	43037.....	9	43516.....	15
40400.....	161	412.....	45	43038.....	7	43520.....	15
40401.....	161, 290	41225.....	235	43040.....	7	43520-8.....	275
40402.....	161	41323.....	229	43041.....	9	43521.....	15
40403.....	163, 285	41342.....	155	43042.....	7	43522.....	15
40405.....	163, 285	41349.....	225	43043.....	9	43525.....	15
4040505.....	291	41350.....	225	43050.....	7	43528.....	15
40412.....	163	41352.....	225	43052.....	39, 293	43529.....	15
40422.....	229, 251	41354.....	225	43058.....	39	43531.....	15
40423.....	229, 251, 291	414.....	45	4306.....	120, 159, 293	43531-8.....	275
40424.....	250	41567.....	231, 252	43080.....	7	43532.....	15
40425.....	250	41568.....	231, 252	43082.....	7	43533.....	15
40430.....	229, 251	41664.....	246	43083.....	9	43540.....	15
40501.....	291	41672.....	239	43086.....	7	43540-8.....	275
40521.....	291	41673.....	239	43087.....	9	4355.....	99
40541.....	291	41880.....	227, 251	43121.....	47	43560.....	15
40561.....	227, 251	41881.....	227, 251, 291	43122.....	47	43560-8.....	275
40562.....	227, 251	4206.....	99, 293	43123.....	47	43563.....	15
40564.....	227, 251	4250.....	169, 293	43125.....	47	43563-8.....	275
40565.....	227, 251	4251.....	169	43126.....	47	43620.....	31
40621.....	227, 251	4260.....	169, 293	43133.....	47	43621.....	31
40634.....	225	4261.....	169	43141.....	165, 294	43622.....	31, 293
40650.....	223	4270.....	169, 293	43142.....	165, 294	43623.....	31, 294
40663.....	225	4271.....	169	43143.....	165, 294	43624.....	31
40671.....	290	42824.....	23	43144.....	165, 294	43625.....	31, 293
40681.....	171	43000.....	7	43145.....	165, 294	43626.....	31, 293
40682.....	171	43002.....	7	4315.....	165	43627.....	31
40683.....	171	43003.....	9	43300.....	19	43628.....	31
40690.....	172	43004.....	7	43302.....	19	43629.....	31
40691.....	172	43005.....	9	43304.....	19	43630.....	31, 293
40731.....	237	43006.....	7	43306.....	19	43631.....	31, 294
40732.....	237	43008.....	7	43308.....	19	43633.....	37
40733.....	237	43009.....	9	4332.....	159, 293	43635.....	37
40735.....	237	43010.....	7	43404.....	19	43635L.....	42
40737.....	237, 287	43011.....	9	43410.....	19	43636.....	37
40790.....	163	43012.....	7	43420.....	19	43636L.....	42
40791.....	163	43013.....	9	43422.....	19	43637.....	37
40792.....	163	43016.....	7	43470.....	23	43638.....	37
40793.....	163	43017.....	9	43500.....	15	4364.....	159, 293
408.....	45	43018.....	7	43500-8.....	275	43640.....	37
410.....	45	43019.....	9	43501.....	15	43647.....	35
41020.....	235	43024.....	7, 63	43501-8.....	275	43648.....	35
41076-1.....	172	43025.....	9, 65	43502-8.....	275	43649.....	35
41077-1.....	172	43030.....	7	43503.....	15	43651.....	35
41082.....	223	43031.....	9	43504.....	15	43653.....	35
41083.....	223	43032.....	7	43505.....	15	43655.....	35

<b>Prod No</b>	<b>Page No</b>	<b>Prod No</b>	<b>Page No</b>	<b>Prod No</b>	<b>Page No</b>	<b>Prod No</b>	<b>Page No</b>
43662.....	37	43981.....	131	44412C.....	63	4551.....	49, 293
43663.....	37	43982.....	131	44414.....	63	4552.....	49
43664.....	37	43983.....	131	44414C.....	63	4553.....	47
43665.....	37	43984.....	132	44416.....	63	4560.....	49
43666.....	37	43986.....	132	44416C.....	63	4560-8.....	277
43668.....	37	43988.....	131	44417.....	65	4563.....	49
43674.....	37	43989.....	131	44418.....	63	45643.....	225
43737.....	67	44010.....	202	44418C.....	63	4571.....	49, 293
43738.....	67	44010SKD.....	202	44420.....	63	4572.....	49
43739.....	67	44011.....	202	44422.....	63	4573.....	49
43743.....	167	44011SKD.....	202	44422C.....	63	4574-8.....	277
43744.....	167	44012.....	202	44430.....	63	4575.....	49
43745.....	67	44030.....	51, 294	44432.....	63	45850.....	239
43772.....	67	44031.....	51, 294	44432C.....	63	4606.....	99
43800.....	19	4410.....	99, 293	44434.....	63	4609.....	99
43801.....	19	4411.....	99, 293	44440.....	63	4650.....	49
43803.....	19	44131.....	171, 285	44460.....	63	4651.....	49
43806.....	23	44132.....	171, 285	44462.....	63	4709.....	99
43807.....	67	44133.....	171, 285	44462C.....	63	4712.....	99
43809.....	67	44134.....	171, 285	4450.....	99, 293	4806.....	99
43811.....	75	44135.....	171, 285	44514.....	61	4900.....	171, 293
43813.....	19	44136.....	171, 285	44518.....	61	49110-1.....	163
43814.....	19	44141.....	171, 285	44520.....	61	49112-1.....	163
43816.....	25	44142.....	171, 285	44522.....	61	49116-1.....	163
43822.....	23	44143.....	171, 285	44524.....	61	49122-1.....	163
43830.....	67	44144.....	171, 285	44530.....	55	4921.....	167
43832.....	67	44145.....	171, 285	44532.....	55	4922.....	167
43834.....	67	44146.....	171, 285	4460.....	99, 293	4924.....	167
43840.....	67	4415.....	171	4470.....	99, 293	4925.....	167
43842.....	67	4416.....	171	4471.....	99, 293	4926.....	167
43850.....	13	4420.....	99, 293	4512.....	28, 39, 293	4928.....	167
43852.....	13	4421.....	99, 293	45222.....	227, 251	4929.....	167
43854.....	13	4425.....	171	4523DFG.....	123	4930.....	167
43856.....	13	4426.....	171	4523FG.....	123	4931.....	167
43858.....	13	4430.....	99, 293	4523WFG.....	123	4962.....	167
43860.....	13	4431.....	99, 293	45267.....	237	500B.....	25
43862.....	13	44400.....	63	4530.....	23	500M.....	25
43864.....	13	44400C.....	63	4530-8.....	275	509.....	99, 293
43866.....	13	44402C.....	63	4530-9.....	275	5105-2.....	37
43868.....	13	44403.....	65	4531.....	23	5108-2.....	37
43872.....	13	44404.....	63	4531-8.....	275	5109-2.....	37, 293
43937.....	33	44404C.....	63	4532.....	23	5109L.....	42
43942.....	45	44405.....	65	4533.....	23	5112-2.....	37, 293
43943.....	45	44406.....	63	4534.....	23	5116-2.....	37, 293
43944.....	45	44410.....	63	4535.....	23	5120.....	37, 293
43965.....	39	44410C.....	63	4549.....	49	5212.....	33, 293
43965L.....	42	44411.....	65	4550.....	49, 293	5212-2.....	33
43980.....	131	44412.....	63	4550-8.....	277	5212-8.....	275

<b>Prod No</b>	<b>Page No</b>	<b>Prod No</b>	<b>Page No</b>	<b>Prod No</b>	<b>Page No</b>	<b>Prod No</b>	<b>Page No</b>
5212-81	275	55522	59	5933	19, 67	601175	145, 283
5212L	42	55524	59	60RS-1	303	601306	152
5216	33, 293	55526	59	60RS-2	303	601405	167
5216-2	33	55528	59	60RS-3	303	601408	167
52163550D	33	55530	59	600111	79	601413	167
52163550E	33	55532	59	600112	79	601416	167
5216-8	275	55534	59	600121	79	601420	167
5216-81	275	55536	59	600122	79	601526	169
5220	33, 293	55538	59	600214	79	601527	169
5220-2	33	55540	59	600216	79	601528	169
52203550	33	55542	59	600220	79	601529	169
52203550A	33	55544	59	600225	79	601642	152
5220-8	275	55546	59	600295	87	601647	152
5220-81	275	55550	59	600296	87	601824	151
5224	33, 293	5570	41, 294	60100PC	147	601825	151, 303
52243550G	33	5571	41	601000	149	601826	151
52243550H	33	5583	41	601001	149	601828	151
5224-8	275	5587	41	601002	149	601829	151
5224-81	275	5601	31, 293	601003	149	601830	151
5232	33, 293	5602	31, 293	601008	145, 281	601834	151
5232-63550J	33	5603	31, 293	601008X	145, 281	601837	151
5232-63550I	33	5610	31, 293	601009	145, 281	601840	151
52412L	42	5612	31	601009X	145, 281	601922	151
5501	33	5614	31, 293	60101	147	601923	151
5501-2	33	5616	31, 293	601012	145, 281	6020	172, 285
5501-81	275	5640	31, 293	601012X	145, 281	602164	151
5505	33	5641	31	601014	145, 281	602164C	151
5506	33, 293	5642	31, 293	601014X	145, 281	602164P	151
5506-2	33	5643	31, 293	60102	147	602202	177
5506-81	275	5644	31	601025	145, 283	602203	177
5506L	42	5645	31	601028	149	602400	47
5508	33	5646	31	601029	149	602424	152
5509	33	575B	25	60103	149	602500	47
5512	33	575M	25	601031	149	60275	169
5517	33	5806	35	601045	145, 283	60277	169
5519	33	5808	35	601075	145, 283	60278	169
5526	33	5810	35, 293	601109	145, 283	60279	169
5526-2	33	5810L	42	601111	145, 283	60280	169
5526-8	275	5812	35	601112	145, 283	6030	169
5526-81	275	5812L	42	601116	145, 283	60300	172
5529	33	5814	35	601119	145, 283	60300-6	165, 285
5529-2	33	5816	35, 293	601123	145, 283	60300-8	165, 285
5532	33, 293	5818	35	601125	145, 283	60300-10	165, 285
5532-81	275	5820	35, 293	601132	145, 283	60300-12	165, 285
5536	41	5822	35, 293	601133	145, 283	60300-16	165, 285
5540	41	5822L	42	601144	145, 283	60300-20	165, 285
5544	41, 294	5832	35, 293	601146	145, 283	60300-24	165, 285
55520	59	5865	131	601164	145, 283	60300-30	165, 285



<b>Prod No</b>	<b>Page No</b>	<b>Prod No</b>	<b>Page No</b>	<b>Prod No</b>	<b>Page No</b>	<b>Prod No</b>	<b>Page No</b>
60300-40	165, 285	6070A	85, 177	607236	175	607711H	177
60306	151	60700HL2	175	607351	165	607712	177
6031	169	60700HL4	175	607352	165	607714	177
60322	152	60700HL6	175	607353	165	607802H	175
60324	152	60700HLC	175	607354	165	607813	171
60344	151	607000C	175	607356	165	607813P	171
60345	151	607000CS	175	607358	165	607813S	171
60346	151	607000H	175	607362	165	607815	171
6041	152	607001	175	607374	165	607815P	171
604144	151	607002	175, 298, 303	607376	165	607815S	171
604174	151	607002D	177, 298	607378	165	607830EW	85, 277
6042	152	607002P	175	607382	165	607830EWC	298
6043	152	607004	175	607400	172	607901	177
604300	165	607004P	175	607410	172	607902	177
604310	165	607006	175	607531	169	607902C	177
604358	167	607006P	175	607550	169	607904	177
604359	167	60708RS	143, 281	607552	169	607904C	177
604360	167	6071A	85, 177	607556	169	607908	177
604361	167	60710RS	143, 281	607560	169	607908C	177
604370	167	60712RS	143, 281	607562	169	607912	177
604371	167	607120C	175	607566	169	607912C	177
604380	167	607120CS	175	607650	87	608002	175
604381	167	607122	175	607651	87	608004	175
604390	167	607122P	175	607652	87	608006	175
604391	167	607124	175	607653	87	608122	175
604392	167	607124P	175	607654	87	608124	175
604393	167	607126	175	607655	87	608126	175
6044	152	607130C	175	607656	87	608132	175
604460	87	607130CS	175	607657	87	608134	175
604606	87	607132	175	607658	87	608136	175
604609	87	607134	175	607680	87	608142	175
606006	145	607136	175	607682	87	608144	175
606007	145	607140C	175	607683	87	608146	175
606009	145	607140CS	175	607685	87	608162	175
606010	145	607142	175	607687	87	608164	175
606011	145	607144	175	607690	87	608166	175
606013	145	607146	175	607691	87	608192	175
606014	145	607160C	175	607692	87	608194	175
606015	145	607160CS	175	607693	87	608212	119
606016	145	607162	175	607695	87	608236	175
606017	145	607164	175	607697	87	60830	169
606040	159	607166	175	607704	177, 298	608530	119
606055	159	607190C	175	607704CS	177	608600	119
606086	159	607190CS	175	607707	177, 298	608615	119
606106	120	607192	175	607707CS	177	608901	129
606122	145	607194	175	607707H	177	608902	129
606902	151	607230C	175	607711	177	608904	129
606903	151	607232	175	607711CS	177	608905	129

<b>Prod No</b>	<b>Page No</b>	<b>Prod No</b>	<b>Page No</b>	<b>Prod No</b>	<b>Page No</b>	<b>Prod No</b>	<b>Page No</b>
608907.....	129	609110.....	119	609310.....	90	609721WP.....	298
608908.....	129	609111.....	49	609316.....	90	609723.....	83
608909.....	129	609112.....	49	60934.....	149	609725.....	83
608913.....	129	609113.....	49	609504.....	298	609801H.....	298
608917.....	129	60912C.....	149	609510.....	83, 298	609801K.....	298
608918.....	129	60912RS.....	143, 281	609510C.....	298	609801L.....	298
608919.....	129	60912SERS.....	143, 281	609510F.....	298	61115.....	147, 283
608924.....	25	60912SERS.....	281	609510W.....	298	61120.....	147, 283
608925.....	25	60912XRS.....	143, 281	609513F.....	298	61120C.....	149
60900.....	53	609121.....	79	609523E.....	85, 298	61125.....	147, 283
609001.....	87	609123.....	79	609530.....	83, 298	61125C.....	149
609002.....	87	609125.....	79	609530C.....	298	61130.....	147, 283
609003.....	87	609131.....	55	609530F.....	298	61130C.....	149
609005.....	87	609132.....	55	609530W.....	298	61200.....	147, 283
609006.....	87	609133.....	55	609550.....	83, 298	61200C.....	149
609007.....	87	60914C.....	149	609550C.....	298	61210.....	147, 283
609009.....	87	60914RS.....	143, 281	609571E.....	85, 298	61210C.....	149
60901.....	53	60914SERS.....	143, 281	609576.....	83, 298	61212.....	147, 283
60902.....	53	60914XRS.....	143, 281	609576LH.....	298	61216.....	147, 283
609030.....	87	609143.....	119	609576W.....	298	61216C.....	149
609031.....	87	609144.....	119	609578.....	83, 298	61220.....	147, 283
609036.....	87	609145.....	119	609578F.....	298	61220C.....	149
609039.....	87	609146.....	119	609578LH.....	298	61224.....	147, 283
60907C.....	149	609147.....	119	609578W.....	298	61224C.....	149
60907RS.....	143, 281	609170.....	90	609590.....	85, 298	61232.....	147, 283
60907SERS.....	143, 281	609171.....	79	609595.....	85	61232C.....	149
60907XRS.....	143, 281	609172.....	79	609600.....	83, 298	61240.....	147, 283
60908C.....	149	609173.....	79	609600C.....	298	61240C.....	149
60908RS.....	143, 281	609179.....	55	609600CS.....	298	61260.....	147, 283
60908SERS.....	143, 281	609183.....	55	609600F.....	298	61260C.....	149
60908XRS.....	143, 281	609184.....	55	609600H.....	298	61280.....	147, 283
609082.....	79	609185.....	55	609600HS.....	298	61280C.....	149
609083.....	79	609190.....	120	609600PN.....	298	61302.....	147, 283
609084.....	79	609191.....	120	609600PNW.....	298	61302C.....	149
609085.....	79	609193.....	120	609600SH.....	298	61305.....	147, 283
609086.....	79	609196.....	79	609600W.....	298	61305C.....	149
609092.....	79	609201.....	77	609620WH.....	298	61308.....	147, 283
609093.....	79	609202.....	77	609633.....	85, 298	61308C.....	149
609094.....	79	609203.....	77	609635.....	85, 298	614.....	131
609096.....	79	609204.....	77	609650E.....	85, 298	614PC.....	131
609097.....	79	609208.....	77	609651.....	85, 298	614R.....	131
60910C.....	149	609209.....	77	609652.....	85	615.....	131
60910RS.....	143, 281	60921.....	149	609653.....	298	61702.....	147, 283
60910SERS.....	143, 281	609211.....	77	609720.....	83, 298	61702C.....	149
60910XRS.....	143, 281	609215.....	77	609720FP.....	298	61704.....	147, 283
609106.....	119	609216.....	77	609720WP.....	298	61704C.....	149
609107.....	119	609270.....	41	609721.....	83, 298	61707.....	147, 283
609109.....	119	609273.....	41	609721FP.....	298	61707C.....	149

Prod No	Page No	Prod No	Page No	Prod No	Page No	Prod No	Page No
61708.....	147, 283	6673.....	299	69844.....	73	7704.....	300
61708C.....	149	6676.....	299	69846.....	73	7711.....	101
61710.....	147, 283	6677.....	299	6986.....	73	7721.....	101
61710C.....	149	6678.....	299	6986L.....	73	7725.....	101
61905.....	147	6679.....	299	69864.....	73	7749.....	299
61905C.....	149	6682.....	299	69866.....	73	7750.....	299
61907.....	147	6686.....	299	6988.....	73	7752.....	299
61907C.....	149	6687.....	299	6990.....	73	7753.....	299
630FMT.....	125	6688.....	299	6993.....	69	7754.....	299
6302FMT.....	125	6693.....	299	6996.....	69	7755.....	299
63910L.....	42	6695.....	299	6997.....	69	7756.....	299
63912L.....	42	6696.....	299	7000.....	39	7760.....	299
6400.....	163	6697.....	299	7006.....	28	7761.....	299
6401.....	163	6705.....	299	7007.....	28	7900.....	69
6413.....	129	6706.....	299	7008.....	28	7901.....	69
6416.....	129	6707.....	299	7038.....	97, 300	7910.....	69
6417.....	129	6708.....	299	7039.....	97	7913.....	69
6426.....	129	6709.....	299	7055.....	25	7914.....	69
6439.....	129	6713.....	71	7060.....	25	7916.....	69
6450.....	129	6716.....	71	7080.....	25	7918.....	69
650B.....	25	6723.....	71	7110.....	56	7919.....	69
650M.....	25	6726.....	71	7111-4.....	56	7920.....	69
6504.....	51	6741.....	71	7112.....	56, 298	7924.....	61
6510.....	55	6843.....	80	7206.....	76	7926.....	61
6524.....	51	6863.....	80	7208.....	76	7928.....	61
6526.....	51	6904.....	25	7210.....	76	7930.....	67
6527.....	51	6904-8.....	275	7212.....	76	7932.....	67
6531.....	71	6907.....	25	7215.....	76	7934.....	67
6532.....	71	6907-8.....	275	7218.....	76	7940.....	23
6534.....	71	6908.....	75	7223.....	76	7942.....	23
6550.....	51	6909.....	75	7325.....	75	7944.....	61
6551.....	51	6914.....	75	7400.....	28	7946.....	61
6552.....	51	6917.....	75	7405.....	28	7948.....	61
6553.....	51	6919.....	75	7410.....	28	800B.....	25
6554.....	51	6931.....	75	7420.....	28	800M.....	25
6600.....	101	6942.....	75	7543.....	302	8004.....	39, 293
6601.....	101	6947.....	75	7545.....	302	8038.....	75
6602.....	299	6954.....	25	7546.....	302	8094.....	75
6603.....	299	6954-8.....	275	7547.....	302	8099.....	75
6605.....	101	6956.....	25	7548.....	302	8100.....	75
6606.....	101	6956-8.....	275	7549.....	302	8104.....	39
6608.....	101	6963.....	71	7550.....	111	8110.....	73
6611.....	101	6966.....	71	7551.....	302	8112.....	73
6616.....	299	6972.....	71	7552.....	302	830FMT.....	125
6620.....	101	6982.....	73	7555.....	111	8302FMT.....	125
6621.....	101	6982L.....	73	7670.....	103	8505.....	39, 293
6625.....	101	6984.....	73	7671.....	103	8508.....	73
6672.....	299	6984L.....	73	7702.....	300	8819.....	73

<b>Prod No</b>	<b>Page No</b>	<b>Prod No</b>	<b>Page No</b>	<b>Prod No</b>	<b>Page No</b>	<b>Prod No</b>	<b>Page No</b>
8821.....	73	9848.....	300	C3630W .....	127	CT1216.....	125, 297
8886.....	71	9850.....	300	C93 .....	201	CT1216-81 .....	279
8887.....	71	9851.....	300	CC11SH.....	255	CT1217.....	125, 297
8888.....	71	9948.....	300	CC11TH .....	255	CT1418.....	125, 297
8910.....	69	ADD4.....	258	CC2036 .....	255, 288	CT1418-81 .....	279
8918.....	69	ADD6.....	258	CC2036DP.....	255	CT1713TR.....	125, 297
8919.....	69	ADDA.....	303	CC2036P .....	255	CW6C .....	201
8920.....	69	ADDC.....	258, 303	CC2243 .....	255, 288	DL1826.....	137
9001.....	300	ADDD.....	258, 303	CCSTR2036 .....	303	DL300.....	137
9002.....	300	ADDR.....	258	CD2036 .....	255	DL300R .....	137
9003.....	300	ADS4 .....	258	CH03 .....	115	EP214.....	117
9004.....	300	ADS8 .....	258	CH15 .....	115	EP215.....	117
9005.....	300	ADSC.....	258, 303	CHI4 .....	302	EP216.....	117
9051.....	103	ADSD.....	258, 303	CHI6 .....	302	EP217.....	117
9052.....	103	ARR112 .....	67	CM1012.....	95, 277	EP320.....	117
91020.....	27	ARR113 .....	53	CM1013.....	95	GR09 .....	117
91040.....	27	ARR113 .....	67	CM1017.....	95	GR09RS .....	302
91055.....	27	ARR120 .....	67	CM1030.....	95	GR10 .....	117
91065.....	27	ARR240 .....	67	CM1032.....	95	Group A.....	27
91070.....	27	BC05 .....	115	CM1033.....	95	Group AT .....	27
91075.....	27	BIN27 .....	188	CM1033P.....	95	Group B.....	27
91080.....	27	BIN27L.....	188	CM1035.....	95, 301	Group BT.....	27
91085.....	27	BIN27L.....	303	CM1037.....	95, 301	Group C.....	27
91090.....	27	BIN36 .....	188	CM1040.....	93	Group CT.....	27
91095.....	27	BIN36L.....	188	CM1042.....	93	Group D .....	27
9148.....	103	BIN36L.....	303	CM1042LP.....	93	Group DT.....	27
9160.....	103	BIN44 .....	188	CM1043.....	93	Group E.....	27
9172.....	103	BIN44L.....	188	CM1045.....	93	Group ET .....	27
9224.....	103	BIN44L.....	303	CM1046.....	93	Group P1.....	27
9248.....	103	BIN4500 .....	303	CM1049.....	93	Group P1T.....	27
9260.....	103	BIN4600 .....	303	CM1050.....	95	Group P2.....	27
9272.....	103	C111 .....	201	CM1058.....	95	Group P2T.....	27
9325.....	300	C135 .....	201	CM1065.....	95	Group P3.....	27
9345.....	300	C2220A .....	201	CM1069.....	95	Group P3T.....	27
9365.....	300	C2222A .....	201	CM1072.....	167	Group P4.....	27
9375.....	300	C2222C.....	201, 302, 303	CM1100.....	93	Group P4T.....	27
9547.....	300	C2222HD .....	201, 303	CM1101.....	93	HL7237.....	157
9561.....	300	C2236 .....	201	CM1102.....	93	HL7237-8 .....	277
9573.....	300	C2236H .....	201	CM1103.....	93	HL7237PS.....	157
9645.....	300	C2237 .....	201, 303	CM1104.....	93	HL8185.....	157
9648.....	300	C32P1 .....	201	CM1105.....	93	HL8185B .....	157
9660.....	300	C32P2 .....	201	CM1125.....	93	HL8185C .....	157
9672.....	300	C35P .....	201	CM1126.....	93	HL8185G .....	157
9675.....	300	C3620W .....	127	CM1127.....	93	HL8185GB .....	157
9710.....	103	C3622 .....	127	CM1128.....	93	HL8185GC .....	157
9712.....	103	C3625 .....	127	CP2036 .....	255	HL8195.....	157
9720.....	103	C3625T.....	127	CT1014.....	125, 297	HL8195B .....	157
9722.....	103	C3630RS .....	302	CT1014-81 .....	279	HL8285.....	157



<b>Prod No</b>	<b>Page No</b>	<b>Prod No</b>	<b>Page No</b>	<b>Prod No</b>	<b>Page No</b>	<b>Prod No</b>	<b>Page No</b>
HL8285B	157	KL444	132	PC300N	137	PSD21EH	80
HL8285G	157	KL800	17	PC301GA	302	PT4824	257
HL8285GB	157	KL805	17	PC301HA	302	RB	199
HLA20	157, 303	KL920	17	PC301LG	302	RC16	199
HLA8	303	KL924	17	PC600N	137	RC16-1	199
HLRP11	303	KL928	17	PC660	137	RC20	199
HLRP5	303	LB10	75	PCD205	22	RC20-1	199
HLRP6	303	LB12	75	PCD206	22	RDC	201
HLRP7	303	LB16	75	PCD207	22	RDC1	201
HLRP999	303	LD1000N	139	PCD209	22	RE	193, 194, 199
HT3220	257	LD1001GA	302	PCD210	22	RE16	193
IC2220	140	LD1001LG	302	PCD211	22	RE16C	193
IC222LH	302	LD111VC	302	PCD220	22	RE25	193
IC222WH	302, 303	LD222LA	302	PCD305	22	RE25C	193
IC2250	140	LD222NLA	302	PCD308	22	RE36	193
IC2250HA	302	LD235GA	302	PCD310	22	RE36C	193
IC2250T	140	LD235LG	302	PCD312	22	RE49	194
IC2254	140	LD236LG	302	PCD313	22	RE49C	194
IC2254CS	302, 303	LD250N	139	PCD316	22	RE9	194
IC225CR	299, 302	LD333FA	302	PCD319	22	RE9C	194
IC225CSB	299, 302, 302	LD350N	139	PCD412	22	REW20S	191
IC225FD	302	LD500N	139	PCD796	22, 293	RF	199
IC225LH	302	LD500NSS	139	PCD801	132	RFP	199
IC225WH	302	LD501BD	302	PS101CS	115	RG16	193
IG1011	120	LRP20	303	PS103	113, 302	RG16-1	193
IG222	119	MY400	135	PS103AT	113, 302	RG16-1C	193
IG224	119	MY410	135	PS203	113, 302	RG16-2	193
IG245	120, 294	MYCK	135	PS204	113	RG16-2C	193
JC1945CB	260	OP304	117	PS204AST	113	RG16-3	193
JC1945L	260, 288	OP305	117	PS304	113, 302	RG16-3C	193
JC1945S	260, 288	OP311	117	PS304AT	113, 302	RG16-4	193
JC1946	260	OP314	117	PS501N	113, 294	RG16-4C	193
KL102	17	OP316	117	PS502N	113, 294	RG25	193
KL108	17	OP371	117	PS6012	113	RG25-1	193
KL115	17	OP373	117	PS601N	113, 294	RG25-1C	193
KL116	17	OSB172	76	PS601N-8	279	RG25-2	193
KL118	17	OSB176	76	PS601N-81	279	RG25-2C	193
KL119	17	OSB178	76	PS601NC	113, 294	RG25-3	193
KL121	17	P614	131	PS602N	113, 294	RG25-3C	193
KL123	17	P614R	131	PS603N	113, 294	RG25-4	193
KL126	17	PC140N	137	PS701B	113, 294	RG25-4C	193
KL127	17	PC146GA	302	PS702	113, 294	RG36	193
KL200	17	PC146LG	302	PS801B	113, 294	RG36-1	193
KL201	17	PC160N	137	PS802	113, 294	RG36-1C	193
KL203	17	PC180N	137	PSD13CH	80	RG36-2	193
KL204	17	PC181GA	302	PSD13EH	80	RG36-2C	193
KL205	17	PC181LG	302	PSD21CH	80	RG36-3	193
KL350	17	PC188N	137	PSD21DEH	80	RG36-3C	193

Prod No	Page No	Prod No	Page No	Prod No	Page No	Prod No	Page No
RG36-4	193	SB70	76	SP18	90	XB35GA	302
RG36-4C	193	SB72	76	SP22	90	XB35LG	302
RG49	194	SB74	76	SPD123	103	XB5	139
RG49-1	194	SB76	76	SPD300	103	XDL3000H	137
RG49-1C	194	SB78	76	SPD300KD	103	XT10000	139
RG49-2	194	SB79	76	SPD303	103	XT10001GA	302
RG49-2C	194	SB90	75	SPD303KD	103	XT10001LG	302
RG49-3	194	SB94	75	SS105	115	XT1400	135
RG49-3C	194	SBA1	89	SS107	302	XT1468L	302
RG9	194	SBC11SH	256	SSD100	107	XT1600	135
RG9-1	194	SBC11TC	256	SSW1	89	XT1800	135
RG9-1C	194	SBC1521	255	ST1532	185	XT2500	139
RG9-2	194	SBC2031	255	ST1544	185	XT2550	302
RG9-2C	194	SBC230	256	ST1556	185	XT2550GA	302
RG9-3	194	SBCC240	255, 303	ST1568	185	XT2550LA	302
RG9-3C	194	SBCC245	255, 303	ST1573	185	XT3000R	135
RHC	201	SBG1	89	ST1587	185	XT5000	139
ROP	199	SC25	132	ST1629	185		
RP	199	SC26	132	ST1630	185		
RPC	199	SC27	132	TC1826GA	302		
RSP	199	SC29	132	TC1826N	137		
RTP	199	SC32	80	TP100	107		
RW20	191	SC40	132	TT005	272		
RW20-1	191	SCL1	89	TT010	272		
RW20-2	191	SD01	89	TT105	272		
RW20-3	191	SEA1	89	TT110	272		
RW30	191	SF1	89	TT175	272		
RW30-1	191	SGR1	89	UC1940	257, 288		
RW30-2	191	SHR1	89	UC3031524	256		
RW30-3	191	SL6011L	89	UC3031827	256		
S275	47	SL6011TC	89	UC4018	257		
S275-8	277	SMMC10	89	UC4031529	256		
S277	47	SMMC12	89	UC4031733	256		
S279	47	SMMC8	89	UC4525	257		
S279-8	277	SMO1624	89	UC5031524	256		
S280	47	SMO2232	89	UC5031827	256		
S282	47	SMO2448	89	UC5032135	256		
S282-8	277	SMOC16	89	UC7022133	256		
S285	47	SMOC24	89	UC7031524	256		
S285-8	277	SMR12	89	UC7031827	256		
S286	47	SMR16	89	UC7032133	256		
S287	47	SMR1624	89	UD1726	137		
S287-8	277	SMR1836	89	WB965	51		
S310	45	SMR24	89	WPM20	117		
S312	45	SMR2448	89	WPM25	117		
S314	45	SMR32	89	WPM45	117		
SB66	76	SMTD16	89	WPM85	117		
SB68	76	SMTD24	89	XB3	139		