

MAKE SURE
IT'S RAK



191144, Санкт-Петербург, ул.Моисеенко, д. 5
Телефон: (812) 335-21-16, (812) 335-21-17
Почта: mail@mirposudy.ru
www.mirposudy.ru

MAKE SURE
IT'S RAK



TABLE OF CONTENTS

En This catalogue is the working instrument of all RAK Porcelain distribution channels. The availability of certain products may vary depending on countries. Please check the availability of the products you would like to purchase with the distributor/importer of RAK Porcelain in your area. Current prices apply.

Fr Ce catalogue est l'outil de travail de tous les circuits de distribution RAK Porcelain. La disponibilité de certains produits pourrait varier selon les pays. Veuillez vérifier auprès du distributeur/importateur de RAK Porcelain de votre région, la disponibilité des produits que vous aimeriez acquérir. Les tarifs actuels font référence.

De Dieser Katalog ist die Arbeitsgrundlage für sämtliche Vertriebstätigkeiten von RAK Porzellan. Die Verfügbarkeit einiger Produkte kann je nach Land variieren. Bitte prüfen Sie bei dem für Ihre Region zuständigen Vertriebspartner bzw. Importeur von RAK Porzellan, ob die von Ihnen gewünschten Produkte verfügbar sind. Maßgeblich ist die aktuelle Preisliste.

Es Este catálogo es la herramienta de trabajo de todos los circuitos de distribución de RAK Porcelain. La disponibilidad de determinados productos puede variar en función de los países. Les rogamos que comprueben, con el distribuidor/importador de RAK Porcelain de su región, la disponibilidad de los productos que deseen adquirir. Los precios actuales sirven de referencia.

	4 SUCCESS STORY		84 METROPOLIS
	6 MAKE SURE IT'S RAK		86 STONELEAF
	10 NABUR		90 MINIMAX
	14 WHITE GOLD		102 NANO
	18 GOLDEN		106 PIXEL
	22 ZEPHYR		110 BUFFET
	26 ALLSPICE		114 BUFFET GN
	32 MAZZA		118 B-CONCEPT
	36 NORDIC		122 TWEEG
	40 FINE DINE		126 1973
	46 LYRA		128 YASMEEN
	50 CLASSIC GOURMET		130 BAHAMAS 1
	54 PLAYA		134 BAHAMAS 2
	58 LINE-Z		138 CASTELLO
	62 SKA		140 UNIVERSAL SAUCER
	68 BANQUET		146 PLATE WARMER
	76 RONDO		148 THERMAL COVER
	80 LEON		150 QUALITY



RAK PORCELAIN'S SUCCESS STORY.

En RAK Porcelain, collections dedicated to professionals

Having a thorough knowledge of the requirements of restaurant and hotel owners, we are able to develop collections that combine innovation, function and design. The flexibility of the different lines on offer, allows for countless combinations, such as our all-purpose saucers that can be used with a variety of items: cups, mugs, small dishes or teapots etc.

The genesis of RAK

Based in the United Arab Emirates at Ras Al Khaimah, RAK Porcelain is part of the RAK Ceramics industrial group, the world's leading producer of ceramics. Equipped with ultramodern production facilities, we now have an annual production capacity of 15 million pieces of porcelain certified to the highest quality standards.

RAK: "a worldwide success story"

Starting in 2005, we have successfully launched innovative professional collections on the global tableware market. Each and every one of our product lines combines exceptional durability and creative spirit, thanks to the inspiration of renowned designers and the strength of our industrial know how to obtain an unflinching solidity.

De RAK Porzellan – Kollektionen für die professionelle Gastronomie

Wir kennen die Anforderungen, die in der Gastronomie an das Geschirr gestellt werden. Aus diesem Wissen heraus entwerfen wir Kollektionen, in denen Innovation, Funktion und Design ineinander verschmelzen. Die Flexibilität der verschiedenen Komponenten ermöglicht zahllose verschiedene Kombinationen. So passen unsere universell einsetzbaren Untertassen wunderbar zu den verschiedensten Geschirrtellen wie Tassen, Becher, Schalen und Teekannen.

Unternehmensgeschichte

RAK Porzellan aus Ras Al Khaimah in den Vereinigten Arabischen Emiraten ist der weltweit größte Produzent von Keramikwaren. In unserer hochmodernen Produktionsanlage werden jährlich 15 Millionen Porzellanteile nach höchsten Qualitätsstandards gefertigt.

RAK: „eine weltweite Erfolgsgeschichte“

Seit dem Jahr 2005 bieten wir unsere innovativen Kollektionen für den professionellen Bereich erfolgreich auf dem internationalen Markt für Tischkultur an. Dank der inspirativen Kraft renommierter Designer und unserem industriellen Know-how vereinen sich in allen unseren Kollektionen außergewöhnliche Robustheit, höchste Kreativität und beständige Qualität.



Fr RAK Porcelain, des collections dédiées aux professionnels

Ayant une parfaite connaissance des exigences des restaurateurs et hôteliers, nous développons des collections qui allient innovation, fonctionnalité et design. La flexibilité des différentes gammes proposées, permet de réaliser d'innombrables combinaisons, comme par exemple nos soucoupes universelles qui fonctionnent avec des pièces très diverses : tasses, mugs, coupelles ou théières etc.

La genèse de RAK

Basée dans les Émirats Arabes Unis à Ras Al Khaimah, RAK Porcelain fait partie du groupe industriel RAK Ceramics, premier producteur de céramique au monde. Dotés d'un équipement de production ultramoderne, nous disposons aujourd'hui d'une capacité de production de 15 millions de pièces de porcelaine par an, certifiées du plus haut standard de qualité.

RAK : « a worldwide success story »

A partir de 2005, nous avons lancé avec succès à l'échelon mondial des collections professionnelles innovantes au sein du marché des arts de la table. Chacune de nos gammes marie solidité exceptionnelle et esprit créatif, grâce à l'inspiration de designers renommés et à la puissance de notre savoir-faire industriel pour l'obtention d'une solidité à toute épreuve.

Es RAK Porcelain, colecciones para los profesionales

Nuestro profundo conocimiento de las exigencias de los restauradores y hosteleros nos permite desarrollar colecciones que conjugan innovación, funcionalidad y diseño. Gracias a la flexibilidad de las distintas gamas de nuestra oferta, podemos realizar infinitas combinaciones, como bien ilustran nuestros platillos universales, que se adaptan a piezas muy diferentes: tazas, mugs, boles o teteras, etc.

El origen de RAK

RAK Porcelain tiene su sede en los Emiratos Árabes Unidos, en Ras Al Khaimah, y forma parte del grupo industrial RAK Ceramics, primer productor de cerámica del mundo. Contamos con medios de producción ultramodernos y, en la actualidad, nuestra capacidad productiva es de 15 millones de piezas de porcelana al año, certificadas al más alto nivel de calidad.

RAK: «a worldwide success story»

Desde 2005, lanzamos al mercado de las artes de la mesa colecciones profesionales innovadoras que han cosechado un gran éxito a escala mundial. Todas nuestras gamas combinan solidez excepcional y espíritu creativo gracias a la inspiración de diseñadores de renombre y a la fuerza de nuestro saber-hacer industrial que nos permite enarbolar una solidez a toda prueba.

MAKE SURE IT'S RAK

^{En} Cutting-edge technology

Using cutting-edge technology our collections are designed to withstand intensive use as well as mechanical and thermal shocks inherent in the profession. By selecting raw materials of the highest quality, our products stand up over time to heat of traditional or microwave ovens, while retaining the brilliance of their enamel and the fineness of their decorations.

An optimised worldwide distribution

Linked to a solid worldwide distribution structure, we rely on a network of experts and operators specialising in tableware to serve you wherever and whenever you desire. We insist on providing you with very short lead times.

^{Fr} Une technologie de pointe

Nos collections sont élaborées grâce à une technologie de pointe pour résister aux usages intensifs ainsi qu'aux chocs thermiques et mécaniques inhérents à la profession. En sélectionnant des matières premières de la plus grande qualité, nos produits résistent sur la durée à la chaleur des fours traditionnels ou micro-ondes, tout en conservant l'éclat de leur émail et la finesse de leurs décorations.

Une distribution mondiale optimisée

Liée à une solide structure de distribution au niveau mondial, nous nous appuyons sur un réseau d'experts et d'opérateurs spécialisés dans les arts de la table afin de vous servir où et quand vous le désirez. Nous tenons à vous assurer des délais d'approvisionnement très courts.

^{De} Spitzentechnologie

Unsere Kollektionen sind aufgrund einer hochentwickelten Technologie äußerst widerstandsfähig gegenüber intensiver thermischer und mechanischer Beanspruchung. Durch die Auswahl qualitativ hochwertiger Rohstoffe sind unsere Produkte dauerhaft hitzebeständig (gleichermaßen ofen- wie mikrowelleneeignet) – ohne Beschädigungen der Glasur bzw. Einbußen beim Dekor.

Optimierter weltweiter Vertrieb

Unser weltweites Vertriebsnetzwerk besteht aus Experten und Spezialisten der Tischkultur, die Ihnen gern mit Rat und Tat zur Seite stehen. Bei uns können Sie sich auf sehr kurze Lieferzeiten verlassen.

^{Es} Una tecnología puntera

Nuestras colecciones están elaboradas con tecnología puntera para lograr que resistan a los usos intensivos y a los choques térmicos y mecánicos inherentes a la profesión. Gracias a unas materias primas de la máxima calidad, nuestros productos soportan a largo plazo el calor de los hornos tradicionales o de los microondas, sin perder el brillo de su esmalte y la delicadeza de sus decoraciones.

Distribución mundial optimizada

La distribución, basada en una sólida estructura a escala mundial, cuenta con el apoyo de una red de expertos y operadores especializados en las artes de la mesa que nos permite prestarle servicio en todas partes y en cualquier momento. Nuestro empeño es asegurar unos plazos de suministro muy ajustados.

SEGMENTATION

- Plain White lines / Collections unies blanches / Die weißen Kollektionen / Colecciones unidas blancas
- Embossed lines / Collections moulurées / Die Relief-Kollektionen / Colecciones molduradas
- Decorated lines / Collections décorées / Die Dekor-Kollektionen / Colecciones condecoradas

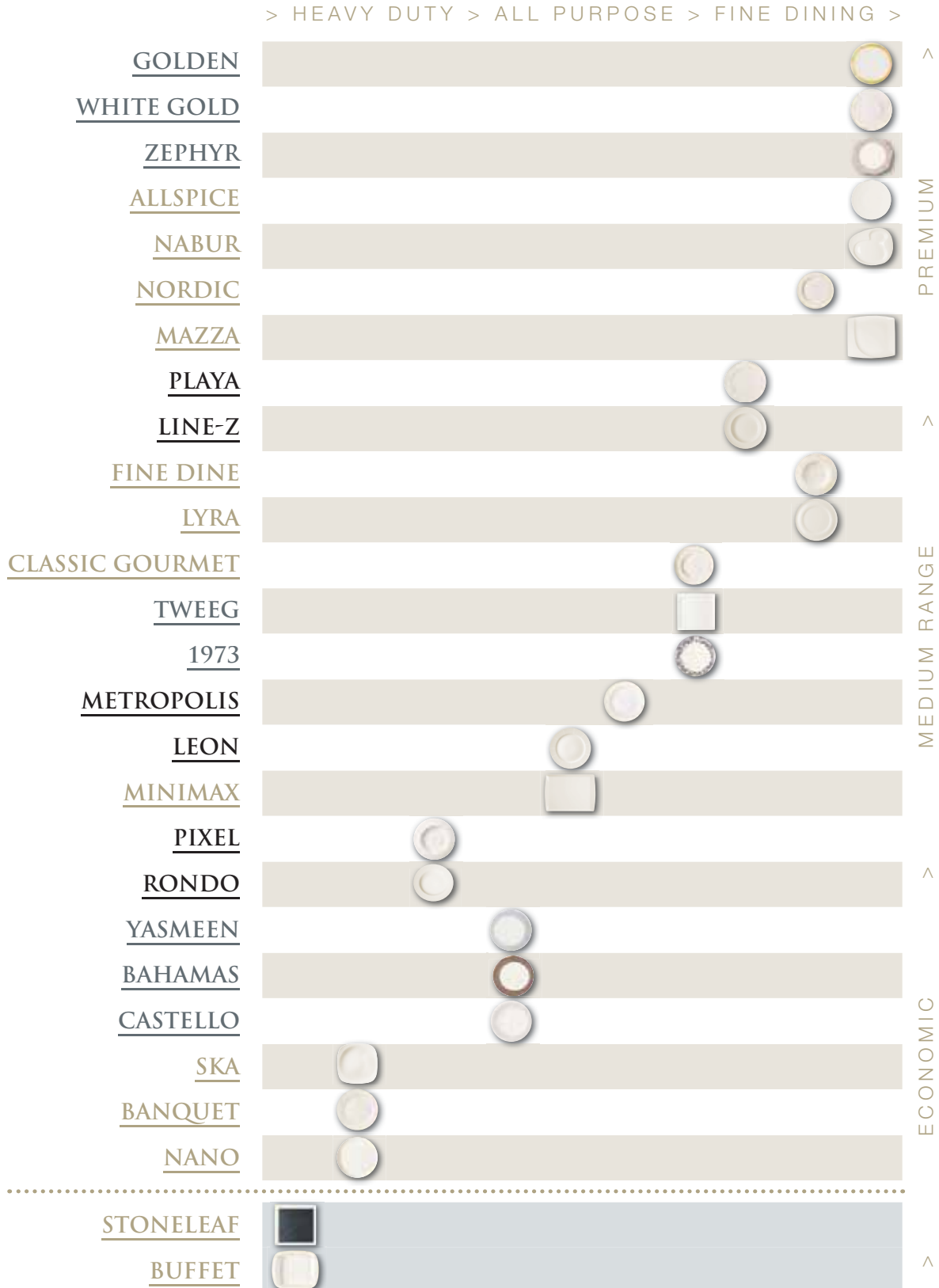

MIKAELA DÖRFEL



En

Finnish-born Mikaela Dörfel has owned her own creative studio in Hamburg since 1997. She has learned her trade at leading international porcelain manufacturers. The artist's design is heavily influenced by Scandinavian culture. "I get my inspiration from nature and simple shapes as well as clear structures", the artist reveals. Her Hamburg studio focuses mainly on porcelain tableware designs and has worked for some of the world's major porcelain producers in Europe, America and Asia. She has created numerous collections for RAK Porcelain including the latest, Nabur, inspired by nature.

De

Die gebürtige Finnin Mikaela Dörfel arbeitet seit 1997 in ihrem eigenen Kreativstudio in Hamburg. Ihre ersten Verdienste erwarb sie sich bei international renommierten Porzellanherstellern. Die Künstlerin lässt sich in ihrem Design sehr stark von der skandinavischen Kultur inspirieren: „Ich lasse mich hauptsächlich von der Natur und von einfachen Formen sowie klaren Strukturen leiten“, erläutert sie. Mikaela Dörfel hat sich im Wesentlichen dem Design von Porzellan für die Tischkultur verschrieben. Ihr Hamburger Studio zählt die größten und renommiertesten Unternehmen in Europa, Amerika und Asien zu seinen Kunden. Für RAK Porzellan hat Mikaela Dörfel zahlreiche Kollektionen entworfen. Auch ihr neuestes Werk, Nabur, ist deutlich von der Natur inspiriert.

Fr

Finlandaise d'origine, Mikaela Dörfel possède depuis 1997 son propre studio créatif à Hambourg. Elle a fait ses armes au sein d'industries de production de porcelaine de référence internationale. L'artiste se caractérise par un design très influencé par la culture scandinave. « Je m'inspire de la nature et des formes simples ainsi que de structures claires » révèle l'artiste. Essentiellement tourné vers le design de porcelaine dédié aux arts de la table, son studio de Hambourg compte à son actif les plus grandes références mondiales d'Europe, d'Amérique et d'Asie. Elle a créée pour RAK Porcelain de nombreuses collections dont la dernière née, Nabur, inspirée de la nature.

Es

Mikaela Dörfel es de origen finlandés y desde 1997 tiene su propio estudio de creación en Hamburgo. Inició su carrera en industrias de producción de porcelana de fama internacional. Los diseños de la artista se caracterizan por una acusada influencia de la cultura escandinava. «Me inspiro en la naturaleza, en las formas sencillas y en estructuras claras», comenta la artista. Su estudio de Hamburgo se dedica esencialmente al diseño de piezas de porcelana para las artes de la mesa y cuenta en su activo con las referencias mundiales más importantes de Europa, América y Asia. Ha creado numerosas colecciones para RAK Porcelain, la más reciente, Nabur, inspirada en la naturaleza.

DOMINIQUE & ALAIN VAVRO



En

The French couple Dominique and Alain Vavro have been at the forefront of French creation for several decades now. The two artists met at the Ecole des Beaux-Arts in Lyon and have been working hand-in-hand ever since. The Vavro couple settled on the banks of the River Saône, a stone's throw away from Paul Bocuse's restaurant, where they fell in love with the world of haute cuisine. Driven by a love of tableware, they understand the needs of the trade and their designs reflect different atmospheres that are as elegant as they are practical, allowing RAK Porcelain to bring innovative and stylish solutions to the world of hotels and catering.

Fr

Voilà plusieurs décennies que le couple français Dominique et Alain Vavro occupe le haut du pavé dans le monde de la création française. Les deux artistes se sont rencontrés sur les bancs de l'Ecole des Beaux-Arts de Lyon et travaillent en véritable symbiose depuis. Installé sur les bords de la Saône, à deux pas du Restaurant de Paul Bocuse, le couple Vavro a eu un coup de foudre pour l'univers de la gastronomie. Animés par une passion pour les arts de la table, ils comprennent les besoins du métier et traduisent, dans leur design, différentes atmosphères aussi élégantes qu'utiles pour apporter avec RAK Porcelain des solutions innovantes et stylées au monde de l'hôtellerie et de la restauration.

De

Seit einigen Jahrzehnten gehört das Ehepaar Dominique und Alain Vavro zu den Top-Designern Frankreichs. Die beiden Künstler lernten sich auf der Ecole des Beaux-Arts in Lyon kennen und arbeiten seitdem in einer regelrechten Symbiose zusammen. Am Ufer der Saône, nur wenige Schritte vom Restaurant von Paul Bocuse entfernt, erkannten die beiden schlagartig ihre Liebe für die Gastronomie. Beseelt von einer Leidenschaft für Tischkultur kennen die beiden die Bedürfnisse des Metiers und entwickeln gleichermaßen elegante wie praktische Design-Lösungen, die sie mit RAK Porzellan in innovative und perfekte Lösungen für die Gastronomie weltweit umsetzen.

Es

Hace ya varias décadas que la pareja francesa formada por Dominique y Alain Vavro se encuentran en la cima del ámbito de la creación en Francia. Los dos artistas se conocieron en las aulas de la Escuela de Bellas Artes de Lyon y desde entonces la simbiosis entre ambos es total. Instalados en las orillas del Saona, a tiro de piedra del Restaurante de Paul Bocuse, entre los Vavro y el universo de la gastronomía se produjo un auténtico flechazo. Movidos por su pasión por las artes de la mesa, conocen las necesidades del oficio y traducen en sus diseños los distintos ambientes, a la vez elegantes y prácticos, para ofrecer, de la mano de RAK Porcelain, soluciones innovadoras y con estilo al mundo de la hostelería y la restauración.



Design Mikaela Dörfel

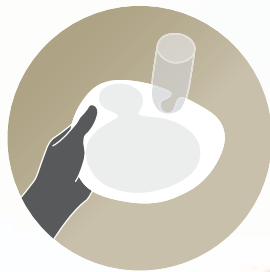



NABUR

En Inspired by nature, Nabur reveals sculptural, organic-curved shapes. An ode to difference, shapes and matter, Nabur celebrates the audacity of leading chefs.

De Von der Natur inspiriert, fällt die Kollektion Nabur durch bildhauerische Formen und organisch geformte Linien auf. Nabur ist eine Ode an die Vielfalt der Formen und Materialien und eine Reminiszenz an die Kühnheit der großen Meisterköche.

Fr Inspirée de la nature, Nabur révèle des formes sculpturales aux courbes organiques. Ode à la différence, aux formes et à la matière, Nabur célèbre l'audace des plus grands chefs.

Es Inspirada en la naturaleza, Nabur ostenta esculturales formas con curvas orgánicas. Ensalzando la diferencia, las formas y la materia, Nabur celebra la audacia de los grandes chefs.



NABUR COLLECTION



Dinner plate 2 basins
Assiette à 2 bassins
Teller mit 2 Vertiefungen
Plato con 2 zonas

NBFP32 32 x 26,5 cm
12 10/16 x 10 7/16"



Dinner coupe plate
Assiette coupe
Teller coupe
Plato coupe

NBFP31 31 x 26,5 cm
12 3/16 x 10 7/16"



NBFP27 27 x 22,5 cm
10 10/16 x 8 14/16"



Breakfast plate 2 basins
Assiette à 2 bassins
Teller mit 2 Vertiefungen
Plato desayuno con 2 zonas

NBFP24 24 x 20 cm
9 7/16 x 7 14/16"



Party plate
Assiette cocktail
Cocktailteller
Plato cóctel

NBPP22 22 x 15,5 cm
8 11/16 x 6 2/16"



Bowl
Bol
Schale
Bol

NBBW23 23 x 19,5 cm - 70 cl
9 1/16 x 7 11/16" - 23 11/16 oz

NBBW19 19 x 15,8 cm - 60 cl
7 8/16 x 6 4/16" - 20 5/16 oz

NBBW15 15 x 12,8 cm - 45 cl
5 14/16 x 5 1/16" - 15 3/16 oz



Dip bowl
Coupelle
Schälchen
Bol hondo

NBDB08 8 x 6,5 cm - 4 cl
3 2/16 x 2 9/16" - 1 6/16 oz



Sauce boat/creamer
Saucière/crémier
Sauciere/Milchkännchen
Salsera/lechera

NBCR25 14 x 9,8 cm - 25 cl
5 8/16 x 3 14/16" - 8 7/16 oz



NBCR15 12,5 x 8,5 cm - 15 cl
4 15/16 x 3 6/16" - 5 1/16 oz

NBCR06 9,2 x 6,4 cm - 6 cl
3 10/16 x 2 8/16" - 2 oz





Breakfast cup

Tasse à déjeuner
Frühstückstasse
Taza de desayuno

NBCU34 9,7 cm - 8,7 cm - 34 cl
3 13/16" - 3 7/16" - 11 8/16 oz



Coffee/tea cup

Tasse à café/thé
Kaffee-/Teetasse
Taza café/té

NBCU26 7,5 cm - 8,7 cm - 26 cl
2 15/16" - 3 7/16" - 8 13/16 oz



**Saucer for breakfast cup
and coffee/tea cup**

Soucoupe tasse à déjeuner
et tasse à café/thé
Untere für Frühstückstasse
und Tee/Kaffeetasse
Platillo para taza de desayuno
y taza café/té

NBSA18 18 x 15 cm
7 1/16 x 5 14/16"



Espresso cup

Tasse à expresso
Espressotasse
Taza a expreso

NBCU09 9 cl
3 1/16 oz



Espresso cup saucer

Soucoupe tasse à expresso
Untere für Espressotasse
Platillo taza a expreso

NBSA15 15 x 12,5 cm
5 14/16 x 4 15/16"



Coffee pot & lid

Cafetière & couvercle
Kaffeekanne & Deckel
Cafetera & tapa

NBCP50 50 cl
16 15/16 oz



Lid for coffee pot

Couvercle pour cafetière
Deckel für Kaffeekanne
Tapa para cafetera

NBCPLD1



Teapot & lid

Théière & couvercle
Teekanne & Deckel
Tetera & tapa

NBTP80 80 cl
27 1/16 oz



Lid for teapot

Couvercle pour théière
Deckel für Teekanne
Tapa para tetera

NBTPLD2



Pieces per box
Pièces par boîte
Stück pro Karton
Piezas por caja

Stored in Europe
Entreposé en Europe
In Europa gelagert
Almacendo en Europa



Design by Vavro





WHITE GOLD

En The grace of its baroque curves gives White Gold a princely appearance. Carved like lace, this collection delicately presents your culinary showpieces, whether simple or more inventive, to entice the gourmet in their discovery of new dishes.

De Mit der barocken Linienführung strahlt die Kollektion White Gold eine fürstliche Anmut aus. Ziselirt wie feinste Spitze steht diese Kollektion für die Zartheit des kulinarischen Werks, das den Gourmet von ganz schlichten bis höchst komplexen Genüssen für Gaumen und Augen zu neuen Kreationen führt.

Fr Avec la grâce de ses courbes baroques, White Gold arbore une allure princière. Ciselée comme de la dentelle, cette collection présente avec délicatesse les œuvres culinaires des plus simples aux plus recherchées pour mener le gourmand, avec les yeux autant qu'avec son palais, vers la découverte de nouveaux mets.

Es La gracia de sus curvas barrocas confiere a White Gold un porte principesco. Cincelada como si se tratara de encaje, esta colección presenta con delicadeza las obras culinarias, de las más sencillas a las más sofisticadas, guiando al gourmet, a través de la vista y del paladar, para que descubra de nuevos manjares.



WHITE GOLD COLLECTION

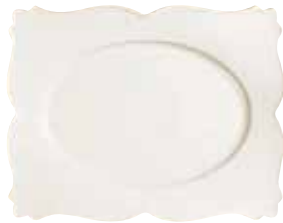

KING

Serving tray rectangular
Plat rectangulaire
Platte rechteckig
Bandeja servicio rectangular

GDRT42 42 x 32,5 cm
16 9/16 x 12 13/16"



Square plate

Assiette carrée
Teller quadratisch
Plato cuadrado

GDSP34 34 x 34 cm
13 6/16" x 13 6/16"



Square plate

Assiette carrée
Teller quadratisch
Plato cuadrado

GDSP26 26 x 26 cm
10 4/16 x 10 4/16"



QUEEN

Round plate

Assiette ronde
Teller rund
Plato redondo

GDRP31 31 cm / 12 3/16"



Round plate

Assiette ronde
Teller rund
Plato redondo

GDRP28 28 cm / 11"

GDRP22 22 cm / 8 11/16"



GDRP16 16 cm / 6 5/16"



PRINCE

Round soup plate

Assiette creuse
Teller tief
Plato hondo

GDDP29 29 cm / 11 7/16"

GDDP23 23 cm / 9 1/16"



PRINCESS

Scalloped plate

Assiette festonnée
Teller festoniert
Plato festoneado

GDSP33 33 cm / 13"



Soup bowl tureen & lid

Soupière & couvercle
Suppenterrine & Deckel
Sopera & tapa

GDSB340 340 cl / 114 15/16 oz



Lid for soup bowl tureen

Couvercle pour soupière
Deckel für Suppenterrine
Tapa para sopra

GDSBLD



Sugar bowl & lid

Sucrier & couvercle
Zuckerdose & Deckel
Azucarero & tapa

GDSU25 25 cl / 8 7/16 oz



Lid for sugar bowl

Couvercle pour sucrier
Deckel für Zuckerdose
Tapa para azucarero

GDSULD





Bowl

Bol
Schale
Bol

GDCU21M 21 cl / 7 2/16 oz



Tea cup

Tasse à thé
Teetasse
Taza a té

GDCU21 21 cl / 7 2/16 oz



Saucer

Soucoupe
Untertasse
Platillo

**GDSA15 > GDCU21M
GDCU21**

15 cm / 5 14/16"



Bowl

Bol
Schale
Bol

GDCU09M 9 cl / 3 1/16 oz



Espresso cup

Tasse à expresso
Espressotasse
Taza a expreso

GDCU09 9 cl / 3 1/16 oz



Saucer

Soucoupe
Untertasse
Platillo

**GDSA12 > GDCU09M
GDCU09**

12 cm / 4 12/16"

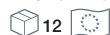

Creamer

Crémier
Milchkännchen
Lechera

GDCR25 25 cl / 8 7/16 oz



Coffee pot & lid

Cafetière & couvercle
Kaffeekanne & Deckel
Cafetera & tapa

GDCP160 160 cl / 54 2/16 oz



Lid for coffee pot

Couvercle pour cafetière
Deckel für Kaffeekanne
Tapa para cafetera

GDCPLD



Teapot & lid

Théière & couvercle
Teekanne & Deckel
Tetera & tapa

GDTP150 150 cl / 50 12/16 oz



Lid for teapot

Couvercle pour théière
Deckel für Teekanne
Tapa para tetera

GDTPLD



 Pieces per box
Pièces par boîte
Stück pro Karton
Piezas por caja

 Stored in Europe
Entreposé en Europe
In Europa gelagert
Almacendo en Europa





GOLDEN

En For a dream setting, Golden puts celebration at the heart of tasting. A variation on the White Gold shape with prestigious gilded marks, it is perfectly suited for presenting the works of leading chefs in a luxurious setting and exceptional atmosphere.

Fr Pour un cadre de rêve, Golden met la fête au cœur de la dégustation. Variation sur la forme White Gold avec le prestige de notes dorées, elle permet de présenter les œuvres des plus grands chefs dans un décor luxueux et une atmosphère d'exception.

De Die Kollektion Golden ist ein einziger Traum, mit der jedes Essen zu einem Fest wird. Die mit Goldverzierungen versehene Variation der Kollektion White Gold ist das passende Porzellan für die Werke der größten Meisterköche und für dekorativen Luxus in einer außergewöhnlichen Atmosphäre.

Es En un marco de ensueño, Golden alegra el placer de la degustación. Esta variación de la forma White Gold ataviada con el prestigio de unas notas doradas, permite presentar las obras de los grandes chefs en un decorado de lujo y en un ambiente excepcional.



GOLDEN COLLECTION



KING GOLDEN

Serving tray rectangular
Plat rectangulaire
Platte rechteckig
Bandeja servicio rectangular

KQRT42 42 x 32,5 cm
16 9/16 x 12 13/16"



Square plate
Assiette carrée
Teller quadratisch
Plato cuadrado

KQSP34 34 x 34 cm
13 6/16" x 13 6/16"



Square plate
Assiette carrée
Teller quadratisch
Plato cuadrado

KQSP26 26 x 26 cm
10 4/16 x 10 4/16"



QUEEN GOLDEN

Round plate
Assiette ronde
Teller rund
Plato redondo

KQRP31 31 cm / 12 3/16"



Round plate
Assiette ronde
Teller rund
Plato redondo

KQRP22 22 cm / 8 11/16"



KQRP16 16 cm / 6 5/16"



PRINCE GOLDEN

Round plate soup
Assiette creuse
Teller tief
Plato hondo

KQDP29 29 cm / 11 7/16"
KQDP23 23 cm / 9 1/16"



PRINCESS GOLDEN

Scallop plate
Assiette festonnée
Teller festoniert
Plato festoneado

KQSP33 33 cm / 13"



Soup bowl tureen & lid
Soupière & couvercle
Suppenterrine & Deckel
Sopera & tapa

KQSB340 340 cl / 114 15/16 oz



Lid for soup bowl tureen
Couvercle pour soupière
Deckel für Suppenterrine
Tapa para sopra

GDSBLD



Sugar bowl & lid
Sucrier & couvercle
Zuckerdose & Deckel
Azucarero & tapa

KQSU25 25 cl / 8 7/16 oz



Lid for sugar bowl
Couvercle pour sucrier
Deckel für Zuckerdose
Tapa para azucarero

GDSULD



**Bowl**

Bol
Schale
Bol

KQCU21M 21 cl / 7 2/16 oz

12

**Tea cup**

Tasse à thé
Teetasse
Taza a té

KQCU21 21 cl / 7 2/16 oz

12

**Saucer**

Soucoupe
Untertasse
Platillo

**KQSA15 > KQCU21M
KQCU21**

15 cm / 5 14/16"

12

**Bowl**

Bol
Schale
Bol

KQCU09M 9 cl / 3 1/16 oz

12

**Espresso cup**

Tasse à expresso
Espressotasse
Taza a expreso

KQCU09 9 cl / 3 1/16 oz

12

**Saucer**

Soucoupe
Untertasse
Platillo

**KQSA12 > KQCU09M
KQCU09**

12 cm / 4 12/16"

12

**Creamer**

Crémier
Milchkännchen
Lechera

KQCR25 25 cl / 8 7/16 oz

6

**Coffee pot & lid**

Cafetière & couvercle
Kaffeekanne & Deckel
Cafetera & tapa

KQCP160 160 cl / 54 2/16 oz

4

Lid for coffee pot

Couvercle pour cafetière
Deckel für Kaffeekanne
Tapa para cafetera

GDCPLD

12

**Teapot & lid**

Théière & couvercle
Teekanne & Deckel
Tetera & tapa

KQTP150 150 cl / 50 12/16 oz

4

Lid for teapot

Couvercle pour théière
Deckel für Teekanne
Tapa para tetera

GDTPLD

12

Pieces per box
Pièces par boîte
Stück pro Karton
Piezas por caja



Design by Vavro





ZEPHYR

En A coloured variation with White Gold's elegant baroque shapes, Zephyr is an invitation to haute cuisine in an intimate atmosphere, with the colour taupe prevailing. Alternating tinted areas on each item provide Zephyr with a character that will delight your guests and give your tables a refined touch.

Fr Variation colorée aux élégantes formes baroques de White Gold, Zephyr invite à la gastronomie dans une atmosphère intimiste, dominée par la couleur taupe. L'alternance de différents aplats sur chaque pièce, procure à Zephyr une personnalité qui va merveilleusement combler vos hôtes et enrichir vos tables d'une note raffinée.

De Als kolorierte Variante der eleganten barocken Form der Kollektion White Gold vermittelt diese vom Farbton Taupe dominierte Kollektion eine intime Atmosphäre. Die wechselnden Oberflächen der einzelnen Teile verleihen Zephyr eine eigene Persönlichkeit, die Ihre Gäste begeistern und Ihren Tisch um einen Hauch von Raffinesse bereichern wird.

Es Zephyr es una variación colorista de White Gold, de elegantes formas barrocas, que invita a la gastronomía en un ambiente intimista dominado por el color taupe. La alternancia de distintos fondos en cada pieza otorga a Zephyr una personalidad que colmará a los invitados a las mil maravillas, dándole a las mesas un toque de refinamiento.



ZEPHYR COLLECTION

KING ZEPHYR



Serving tray rectangular
Plat rectangulaire
Platte rechteckig
Bandeja servicio rectangular

D1GDRT42 42 x 32,5 cm
16 9/16 x 12 13/16"



Square plate
Assiette carrée
Teller quadratisch
Plato cuadrado

D1GDSP34 34 x 34 cm
13 6/16" x 13 6/16"



Square plate
Assiette carrée
Teller quadratisch
Plato cuadrado

D1GDSP26 26 x 26 cm
10 4/16 x 10 4/16"



QUEEN ZEPHYR



Round plate
Assiette ronde
Teller rund
Plato redondo

D1GDRP31 31 cm / 12 3/16"



Round plate
Assiette ronde
Teller rund
Plato redondo

D1GDRP28 28 cm / 11"

D1GDRP22 22 cm / 8 11/16"



D1GDRP16 16 cm / 6 5/16"



PRINCE ZEPHYR



Round soup plate
Assiette creuse
Teller tief
Plato hondo

D1GDDP29 29 cm / 11 7/16"

D1GDDP23 23 cm / 9 1/16"



PRINCESS ZEPHYR



Scallop plate
Assiette festonnée
Teller festoniert
Plato festoneado

D1GDSP33 33 cm / 13"



Soup bowl tureen & lid
Soupière & couvercle
Suppenterrine & Deckel
Sopera & tapa

D1GDSB340 340 cl / 114 15/16 oz



Lid for soup bowl tureen

Couvercle pour soupière
Deckel für Suppenterrine
Tapa para sopra

GDSBLD



Sugar bowl & lid

Sucrier & couvercle
Zuckerdose & Deckel
Azucarero & tapa

D1GDSU25 25 cl / 8 7/16 oz



Lid for sugar bowl

Couvercle pour sucrier
Deckel für Zuckerdose
Tapa para azucarero

GDSULD



**Bowl**

Bol
Schale
Bol

D1GDCU21M 21 cl / 7 2/16 oz

12

**Tea cup**

Tasse à thé
Teetasse
Taza a té

D1GDCU21 21 cl / 7 2/16 oz

12

**Saucer**

Soucoupe
Untertasse
Platillo

D1GDSA15 > 1GDCU21M
D1GDCU21

15 cm / 5 14/16"

12

**Bowl**

Bol
Schale
Bol

D1GDCU09M 9 cl / 3 1/16 oz

12

**Espresso cup**

Tasse à expresso
Espressotasse
Taza a expreso

D1GDCU09 9 cl / 3 1/16 oz

12

**Saucer**

Soucoupe
Untertasse
Platillo

D1GDSA12 > D1GDCU09M
D1GDCU09

12 cm / 4 12/16"

12

**Creamer**

Crémier
Milchkännchen
Lechera

D1GDCR25 25 cl / 8 7/16 oz

6

**Coffee pot & lid**

Cafetière & couvercle
Kaffeekanne & Deckel
Cafetera & tapa

D1GDCP160 160 cl / 54 2/16 oz

4

Lid for coffee pot

Couvercle pour cafetière
Deckel für Kaffeekanne
Tapa para cafetera

GDCPLD

12

**Teapot & lid**

Théière & couvercle
Teekanne & Deckel
Tetera & tapa

4

D1GDTP150 150 cl / 50 12/16 oz

Lid for teapot

Couvercle pour théière
Deckel für Teekanne
Tapa para tetera

GDTPLD

12

Pieces per box
Pièces par boîte
Stück pro Karton
Piezas por caja





ALLSPICE

En With AllSpice, you can give free rein to your imagination; cooking has grown out of faraway influences and travels. The sleek and pioneering style of the collection will contrast with the sophistication of your culinary creations.

Fr Avec AllSpice, laissez libre cours à votre imagination; la cuisine est née d'influences d'ailleurs et du voyage. Le style épuré et novateur de la collection contraste avec la sophistication de vos créations culinaires.

De AllSpice lässt Ihrer Phantasie freien Lauf! Die Küche steckt voller Einflüsse aus der guten alten Zeit und der großen weiten Welt. Der schlichte und moderne Stil der Kollektion steht im Kontrast zur Komplexität Ihrer kulinarischen Kreationen.

Es Deje volar su imaginación con AllSpice; con esta colección la cocina es fruto de influencias lejanas y del viaje. El estilo depurado e innovador de la colección contrasta con la sofisticación de las creaciones culinarias.



ALL SPICE COLLECTION



CHIVES

Square plate, 3 round indents

Assiette carrée,
3 encoches rondes
Teller quadratisch,
3 runde Flächen
Plato cuadrado,
3 estanques redondos

SPCH30 30 x 30 cm
11 13/16 x 11 13/16"



Round bowl

Bol rond
Schale rund
Bol redondo

SPCB32 14 x 3,5 cm - 32 cl
5 8/16 x 1 6/16" - 10 13/16 oz



Round bowl

Bol rond
Schale rund
Bol redondo

SPCB20 11 cm - 3,5 cm - 20 cl
4 5/16" - 1 6/16" - 6 12/16 oz



SPCB11 8 cm - 3,5 cm - 11 cl
3 2/16" - 1 6/16" - 3 12/16 oz



Cover for plate

Cloche pour assiette
Glocke für Teller
Campana para plato

SPLD01 13 x 13 cm
5 2/16 x 5 2/16"



ANGELICA

Square plate, 2 indents oval

Assiette carrée, 2 encoches ovales
Teller quadratisch, 2 Flächen oval
Plato cuadrado, 2 estanques ovales

SPAN30 30 x 30 cm
11 13/16 x 11 13/16"



FENNEL

Square plate, 2 half moon indents

Assiette carrée,
2 encoches demi-lune
Teller quadratisch,
2 Vertiefungen Halbmond
Plato cuadrado,
2 estanques media luna

SPFN30 30 x 30 cm
11 13/16 x 11 13/16"



LAVENDER

Square plate, 1 indent oval

Assiette carrée, 1 bassin ovale
Teller quadratisch, 1 Vertiefung oval
Plato cuadrado, 1 estanque oval

SPLV30 30 x 30 cm
11 13/16 x 11 13/16"



THYME

Rectangular tray, 3 compartments

Plat rectangulaire,
3 compartiments
Platte rechteckig,
3 Vertiefungen
Fuente rectangular,
3 compartimentos

SPRP3B 38 x 18 cm
14 15/16 x 7 1/16"



CURRY

Square tray, 4 compartments

Plat carré, 4 compartiments
Platte quadratisch, 4 Vertiefungen
Fuente cuadrado,
4 compartimentos

SPSP4I 30 x 30 cm
11 13/16 x 11 13/16"





PAPRIKA

Rectangular tray 3 compartments

Plat rectangulaire,
3 compartiments
Platte rechteckig, 3 Vertiefungen
Fuente rectangular,
3 compartimentos

SPRP31 37 x 12,5 cm
14 9/16 x 4 15/16"



ANIS

Rectangular tray for 4 cups without handle

Plat rectangulaire pour
4 tasses sans anse
Platte rechteckig für
4 Tassen ohne Henkel
Fuente rectangular para
4 tazas sin asa

SPRP4BW 36 x 11 cm
14 3/16 x 4 5/16"



JUNIPER

Rectangular tray for 3 cups without handle

Plat rectangulaire pour
3 tasses sans anse
Platte rechteckig für
3 Tassen ohne Henkel
Fuente rectangular para
3 tazas sin asa

SPRP3BW 30 x 11 cm
11 13/16 x 4 5/16"



BASIL

Cup without handle

Tasse sans anse
Tasse ohne Henkel
Taza sin asa
SPCU09 9 cl / 3 1/16 oz
SPCU07 7 cl / 2 6/16 oz

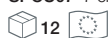

PEPPER

Presentation tray rectangular

Plat rectangulaire de présentation
Platte rechteckig für Vorführung
Fuente rectangular de presentación

SPRP30 30 x 11 cm
11 13/16 x 4 5/16"



CINNAMON

Rectangular plate, 1 indent round

Plat rectangulaire,
1 encoche ronde
Teller rechteckig,
1 Vertiefung rund
Plato rectangular,
1 estanque redondo

SPRR29 29 x 22 cm
11 7/16 x 8 11/16"



 Pieces per box
Pièces par boîte
Stück pro Karton
Piezas por caja

 Stored in Europe
Entreposé en Europe
In Europa gelagert
Almacendo en Europa



ALL SPICE COLLECTION



CORIANDRE

**Rectangular plate,
1 indent square**
Assiette rectangulaire,
1 encoche carrée
Teller rechteckig,
1 Fläche quadratisch
Plato rectangular,
1 estanque cuadrado

SPRS29 29 x 22 cm
11 7/16 x 8 11/16"



VANILLA

Flat plate oval
Assiette plate ovale
Teller flach oval
Plato llano oval

SPEY35 35 x 26 cm / 13 12/16 x 10 4/16"



SPEY19 19 x 14 cm / 7 8/16 x 5 8/16"



CAYENNE

Flat plate oval
Assiette plate ovale
Teller flach oval
Plato llano oval

SPEG36 34 x 28 cm / 13 6/16 x 11"



SPEG19 19 x 16 cm / 7 8/16 x 6 5/16"



SESAME

**Square plate,
1 indent rectangular**
Assiette carrée,
1 encoche rectangulaire
Teller quadratisch,
1 Fläche rechteckig
Plato cuadrado,
1 estanque rectangular

SPDP30 30 x 30 cm
11 13/16 x 11 13/16"



SPDP19 19 x 19 cm
7 8/16 x 7 8/16"



CILANTRO

Flat round plate
Assiette plate ronde
Teller flach rund
Plato llano redondo

SPCP29 29 cm / 11 7/16"



PEPPERMINT

Square plate, 1 oval indent
Assiette carrée, 1 bassin ovale
Teller quadratisch, 1 Fläche oval
Plato cuadrado, 1 estanque oval

SPSO30 30 x 30 cm
11 13/16 x 11 13/16"





TAMARIND

**Oval plate,
1 indent rectangular**
Plat ovale,
1 encoche rectangulaire
Platte oval,
1 Fläche rechteckig
Fuente oval,
1 estanque rectangular

SPTM30 30 x 12 cm
11 13/16 x 4 12/16"



GINGER

Square plate
Assiette carrée
Teller quadratisch
Plato cuadrado

SPSP29 29 x 29 cm
11 7/16 x 11 7/16"



SPSP27 27 x 27 cm
10 10/16 x 10 10/16"



SPSP25 25 x 25 cm
9 13/16 x 9 13/16"

SPSP14 14 x 14 cm
5 8/16 x 5 8/16"



CURCUMA

Square bowl
Bol carré
Schale quadratisch
Plato cuadrado

SPSB22 22 x 22 cm
8 11/16 x 8 11/16"

SPSB15 15 x 15 cm
5 14/16 x 5 14/16"

SPSB13 13 x 13 cm
5 2/16 x 5 2/16"



WASABI

Rectangular plate
Plat rectangulaire
Platte rechteckig
Fuente rectangular

SPRP28 28 x 14 cm
11 x 5 8/16"

OPST24 24 x 14 cm
9 7/16 x 5 8/16"



Rectangular tray, 2 indents*

Plat rectangulaire, 2 empreintes*
Platte rechteckig, 2 Ringe*
Fuente rectangular, 2 huellas*

SPRP28IN 28 x 14 cm
11 x 5 8/16"

SPRP18IN 18 x 14 cm
7 1/16 x 5 8/16"



Rectangular tray, 3 indents*

Plat rectangulaire, 3 empreintes*
Platte rechteckig, 3 Ringe*
Fuente rectangular, 3 huellas*

SPRP24IN 24 x 14 cm
9 7/16 x 5 8/16"



CHILLI

Bowl
Bol
Schale
Bol

SPCU18 18 cl / 6 1/16 oz



*Futher details page 141-145

*Voir détails en page 141-145

*Einzelheiten, siehe Seite 141-145

*Ver detalles página 141-145



Design Mikaela Dörfel





MAZZA

En Bold and graceful, the Mazza product line is the perfect setting for your most avant-garde creations. Its novel and diverse shapes, inspired by the current fusion-food movement, offer a number of possible variations for very contemporary productions.

Fr Audacieuse et svelte, la gamme Mazza sert de cadre idéal à vos créations les plus avant-gardistes. Ses formes inédites et variées, nées du courant fusion-food offrent diverses déclinaisons pour des mises en scènes très contemporaines.

De Die kühne und graziöse Kollektion Mazza bildet den idealen Rahmen für avantgardistische Kreationen. Die neuen und abwechslungsreichen, von der aktuellen Fusion-Food-Welle inspirierten Formen bieten verschiedenste Möglichkeiten, Ihre Kompositionen auf zeitgenössische Weise in Szene zu setzen.

Es Audaz y esbelta, la gama Mazza constituye el marco ideal para las creaciones más vanguardistas. Sus formas inéditas y variadas, surgidas de la corriente fusion-food, ofrecen distintas declinaciones para escenografías absolutamente contemporáneas.



MAZZA COLLECTION



Flat square plate

Assiette plate carrée
Teller flach quadratisch
Plato llano cuadrado

MZSP32 32 x 29 cm
12 10/16 x 11 7/16"

MZSP26 26 x 23,4 cm
10 4/16 x 9 3/16"

MZSP20 20 x 18 cm
7 14/16 x 7 1/16"



Flat rectangular plate

Assiette plate rectangulaire
Teller flach rechteckig
Plato llano rectangular

MZRP32 32 x 20,9 cm
12 10/16 x 8 4/16"

MZRP26 26 x 17 cm
10 4/16 x 6 11/16"

MZRP20 20 x 13 cm
7 14/16 x 5 2/16"



Cocktail plate

Assiette cocktail
Cocktailteller
Plato cóctel

MZCP32 32 x 9,4 cm
12 10/16 x 3 11/16"

MZCP26 26 x 7,6 cm
10 4/16 x 3"

MZCP20 20 x 6,4 cm
7 14/16 x 2 8/16"



Baguette tray

Plat baguette
Platte baguette
Bandeja baguette

MZBP50 50 x 11 cm
19 11/16 x 4 5/16"



MZBP44 44 x 10,6 cm
17 5/16 x 4 3/16"

MZBP38 38 x 10,2 cm
14 15/16 x 4"

MZBP26 26 x 10 cm
10 4/16 x 3 15/16"



MZBP20 20 x 7,5 cm
7 14/16 x 2 15/16"



Twin plate

Plat twin
Platte twin
Plato doble twin

MZTM53 53 x 17 cm
20 14/16 x 6 11/16"

MZTW53 53 x 30 cm
20 14/16 x 11 13/16"

MZTP42 42 x 11 cm
16 9/16 x 4 5/16"



MZTP32 32 x 10 cm
12 10/16 x 3 15/16"



Ellipse plate

Plat ellipse
Platte elipse
Plato elipse

MZEP32 32 x 20,9 cm
12 10/16 x 8 4/16"

MZEP26 26 x 17 cm
10 4/16 x 6 11/16"

MZEP20 20 x 13 cm
7 14/16 x 5 2/16"



**Mini rectangular dish**

Coupelle rectangulaire

Schälchen rechteckig

Rabanera mini rectangular

MZMR11 10,8 x 5,4 cm
4 4/16 x 2 2/16"**Mini square dish**

Coupelle carrée

Schälchen quadratisch

Rabanera mini cuadrada

MZMS08 8 x 7,5 cm
3 2/16 x 2 15/16"

 Pieces per box
Pièces par boîte
Stück pro Karton
Piezas por caja

 Stored in Europe
Entreposé en Europe
In Europa gelagert
Almacendo en Europa



Design by Vavro





NORDIC

En Inspired by Scandinavian design, Nordic's rectilinear silhouette and minimalist sobriety give it a typically Sixties style. Designed specifically for professionals, Nordic is easily stackable. All of its items have been designed to infinitely modular.

Fr Inspiré du design scandinave, Nordic possède un style caractéristique des années 60 avec une silhouette rectiligne d'une sobriété minimaliste. Spécialement conçue pour les professionnels, Nordic s'empile à merveille. Chacune de ses pièces est pensée pour être modulable à l'infini.

De Die vom Design Skandinaviens inspirierte Kollektion Nordic verströmt den charakteristischen Stil der 1960er Jahre mit einer geradlinigen Silhouette und minimalistischen Zurückhaltung. Die Kollektion wurde speziell für den professionellen Bereich entworfen und lässt sich wunderbar stapeln. Jedes einzelne Teil ist so konzipiert, dass es uneingeschränkt modular eingesetzt werden kann.

Es Inspirada en el diseño escandinavo, Nordic posee un estilo característico de los años sesenta, con una silueta rectilínea de sobriedad minimalista. Especialmente concebida para los profesionales, Nordic se apila de maravilla. Cada una de sus piezas está pensada para ser infinitamente modulable.



NORDIC COLLECTION



Flat plate with rim

Assiette plate à aile
Teller flach mit Rand
Plato llano con ala

NOFP32 32 cm / 12 10/16"

NOFP28 28 cm / 11"

NOFP24 24 cm / 9 7/16"



Flat rimless plate/lid

Assiette plate sans aile/couvercle
Teller flach ohne Rand/Deckel
Plato llano sin ala/tapa

NOLD23 > NODP23

23 cm / 9 1/16"



NOLD20 > NODP20

20 cm / 7 14/16"

NOLD16 > NOBW16

16 cm / 6 5/16"

NOLD14 > NOBW14

14 cm / 5 8/16"

NOLD12 > NOBW12

12 cm / 4 12/16"



Deep plate

Assiette creuse
Teller tief
Plato hondo

NODP23 > NOFP32

23 cm / 9 1/16"

NODP20 > NOFP28

20 cm / 7 14/16"



Mini plate with rim

Mini assiette à aile
Mini-Teller mit Rand
Mini plato con ala

NOBD01 6 cm / 2 6/16"



Bowl

Bol
Schale
Bol

NOBW16 16 cm - 7 cm
6 5/16" - 2 12/16"



NOBW14 14 cm - 6 cm
5 8/16" - 2 6/16"

NOBW12 12 cm - 5 cm
4 12/16" - 1 15/16"



Mise en bouche/Cup

Mise en bouche/Tasse
Mise en bouche/Tasse
Mise en bouche/Taza

NOMB1 9 cl / 3 1/16 oz



Breakfast cup

Tasse à déjeuner
Frühstückstasse
Taza de desayuno

NOCU30 30 cl / 10 2/16 oz



Tea cup

Tasse à thé
Teetasse
Taza a té

NOCU23 23 cl / 7 12/16 oz



Saucer for Breakfast/tea cup

Soucoupe tasse à déjeuner/thé
Untere Frühstücks- Teetasse
Platillo taza a desayuno/té

NOSA3 15,5 cm / 6 2/16"





Coffee cup

Tasse à café
Kaffeetasse
Taza a café

NOCU20 20 cl / 6 12/16 oz

12



Saucer for coffee cup

Soucoupe pour tasse à café
Untere für Kaffeetasse
Platillo para taza a café

NOSA2 14 cm / 5 8/16"

6



Espresso cup

Tasse à espresso
Espressotasse
Taza a expreso

NOCU09 9 cl / 3 1/16 oz

12



Saucer for espresso cup

Sous-tasse pour tasse espresso
Untere für Espressotasse
Platillo para taza a expreso

NOSA1 10 cm / 3 15/16"

12



Mug

Chope
Becher
Mug

NOMG33 33 cl / 11 3/16 oz

6



Coffee pot

Cafetière
Kaffeekanne
Cafetera

NOCP100 100 cl / 33 13/16 oz

NOCP40 40 cl / 13 8/16 oz

4

Lid for coffee pot

Couvercle pour cafetière
Deckel für Kaffeekanne
Tapa para cafetera

NOCPD2 > NOCP100

NOCPD1 > NOCP40

12



Teapot

Théière
Teekanne
Tetera

NOTP100 100 cl / 33 13/16 oz

NOTP40 40 cl / 13 8/16 oz

4

Lid for teapot

Couvercle pour théière
Deckel für Teekanne
Tapa para tetera

NOTPLD2 > NOTP100

NOTPLD1 > NOTP40

12



Creamer/Jug

Crémier/Carafe
Milchkännchen/Karaffe
Lechera/Jarra

NOCR50 50 cl / 16 15/16 oz

NOCR15 15 cl / 5 1/16 oz

6



Pepper shaker

Poivrier
Pfefferstreuer
Pimentero

NOPS01

12



Salt shaker

Salière
Salzstreuer
Salero

NOSS01

12

Pieces per box
Pièces par boîte
Stück pro Karton
Piezas por caja



Design by Vavro



FINE DINE

En Fine Dine's ultra sleek line gives it a timeless elegance. Gourmets love the refinement of its whiteness contrasting with the colours of inventive delicacies.

De Die schlichten Linien verleihen der Kollektion Fine Dine eine zeitlose Eleganz. Feinschmecker schätzen die raffinierte Weiße als Kontrast zu den Farben der Speisen.

Fr Les lignes très épurées de Fine Dine lui confèrent une élégance intemporelle. Les gourmets apprécient le raffinement de sa blancheur qui tranche avec les couleurs de mets recherchés.

Es Las líneas muy depuradas de Fine Dine le confieren una elegancia atemporal. Los gourmets aprecian el refinado color blanco que rompe con los colores de sofisticados manjares.



FINE DINE COLLECTION



Flat plate

Assiette plate
Teller flach
Plato llano

FDFP33 33 cm / 13"

FDFP31 31 cm / 12 3/16"



FDFP29 29 cm / 11 7/16"

FDFP27 27 cm / 10 10/16"

FDFP25 25 cm / 9 13/16"

FDFP22 22 cm / 8 11/16"



FDFP16 16 cm / 6 5/16"



Deep plate

Assiette creuse
Teller tief
Plato hondo

FDDP31 31 cm / 12 3/16"



FDDP23 23 cm / 9 1/16"



Gourmet flat plate

Assiette plate gourmet
Gourmetteller flach
Plato llano gourmet

FDGF29 29 cm / 11 7/16"



Gourmet deep plate

Assiette creuse gourmet
Gourmetteller tief
Plato hondo Gourmet

FDGD29 29 cm / 11 7/16"

FDGD26 26 cm / 10 4/16"



Cover for gourmet deep plate

Cloche pour assiette
creuse gourmet
Glocke für Gourmetteller tief
Campana para gourmet
plato hondo

FDCL02 > **FDGD29**

15,5 cm / 6 2/16"

FDCL01 > **FDGD26**

13,6 cm / 5 6/16"



Oval platter

Plat ovale
Platte oval
Fuente oval

FDOP30 30 x 8 cm

11 13/16 x 3 2/16"



Oval platter

Plat ovale
Platte oval
Fuente oval

FDOP46 46 x 22 cm

18 2/16 x 8 11/16"

FDOP40 40 x 19 cm

15 12/16 x 7 8/16"



Oval platter

Plat ovale
Platte oval
Fuente oval

FDOP36 36 x 27 cm

14 3/16 x 10 10/16"

FDOP34 34 x 25,5 cm

13 6/16 x 10 1/16"



Salad bowl oval

Saladier ovale
Salatschale oval
Ensaladera oval

FDBO27 27 x 19 x 6 cm

10 10/16 x 7 8/16 x 2 6/16"

FDBO24 24 x 16 x 8 cm

9 7/16 x 6 5/16 x 3 2/16"

FDBO16 16 x 11 x 5 cm

6 5/16 x 4 5/16 x 1 15/16"



Salad bowl round

Saladier rond
Salatschale rund
Ensaladera redondo

FDBS23 23 cm - 140 cl

9 1/16" - 47 5/16 oz



**Bowl round**

Bol rond
Schale rund
Bol redondo

FDBI14 14 cm - 6,7 cm - 45 cl
5 8/16" - 2 10/16" - 15 3/16 oz

FDBI12 12 cm - 6 cm - 28 cl
4 12/16" - 2 6/16" - 9 7/16 oz

FDBI11 11 cm - 5 cm - 22 cl
4 5/16" - 1 15/16" - 7 7/16 oz

FDBI08 8 cm - 11 cl
3 2/16" - 3 12/16 oz

**Cream soup bowl 2 handles**

Tasse bouillon 2 anses
Suppentasse 2 Henkel
Bol consommé 2 asas

FDCS35 11 cm - 35 cl
4 5/16" - 11 13/16 oz

**Saucer for cream soup bowl**

Soucoupe pour tasse bouillon
Untere für Suppentasse
Platillo para bol consommé

FDSA19 19 cm / 7 8/16"

**Breakfast cup**

Tasse à déjeuner
Frühstückstasse
Taza de desayuno

FDCU30 30 cl / 10 2/16 oz

**Breakfast cup without handle**

Tasse à déjeuner sans anse
Frühstückstasse ohne Henkel
Taza de desayuno sin asa

FDCU30M1 30 cl / 10 2/16 oz

**Saucer for breakfast cup**

Soucoupe pour tasse à déjeuner
Untere für Frühstückstasse
Platillo para taza de desayuno

FDSA17 17 cm / 6 11/16"

**Square saucer for breakfast cup**

Soucoupe carrée
pour tasse à déjeuner
Untere quadratisch
für Frühstückstasse
Platillo cuadrado
para taza de desayuno

OPSA14 14 cm / 5 8/16"

**Tea/coffee cup**

Tasse à thé/café
Tee- Kaffeetasse
Taza a té/café

FDCU25 25 cl / 8 7/16 oz

FDCU20 20 cl / 6 12/16 oz

**Saucer for tea/coffee cup**

Soucoupe pour tasse à thé/café
Untertasse für Tee- Kaffeetasse
Platillo para taza a té/café

FDSA15 15 cm / 5 14/16"

**Espresso Cup**

Tasse à expresso
Espressotasse
Taza a expresso

FDCU09 9 cl / 3 1/16 oz

**Saucer for espresso cup**

Soucoupe pour tasse à expresso
Untere für Espressotasse
Platillo para taza a expresso

FDSA13 13 cm / 5 2/16"

**Square saucer for espresso cup**

Soucoupe carrée
pour tasse à expresso
Untere quadratisch
für Espressotasse
Platillo cuadrado
para taza expresso

OPSA12 12,8 cm / 5 1/16"





FINE DINE COLLECTION



Mug

Chope
Becher
Mug

FDMU30 30 cl / 10 2/16 oz
 12



Coffee pot & lid

Cafetière & couvercle
Kaffeekanne & Deckel
Cafetera & tapa

FDCP70 70 cl / 23 11/16 oz
 4

FDCP35 35 cl / 11 13/16 oz
 4

Lid for coffee pot

Couvercle pour cafetière
Deckel für Kaffeekanne
Tapa para cafetera

FDCPLD2 > FDCP70
 24

FDCPLD1 > FDCP35
 12



Teapot & lid

Théière & couvercle
Teekanne & Deckel
Tetera & tapa

FDTP80 80 cl / 27 1/16 oz
 4

FDTP40 40 cl / 13 8/16 oz
 4

Lid for teapot

Couvercle pour théière
Deckel für Teekanne
Tapa para tetera

FDTPLD2 > FDTP80
 12

FDTPLD1 > FDTP40
 12



Creamer

Crémier
Milchkännchen
Lechera

FDCR40 40 cl / 13 8/16 oz
 6

FDCR25 25 cl / 8 7/16 oz

FDCR15 15 cl / 5 1/16 oz
 6

FDCR05 5 cl / 1 11/16 oz
 24



Sugar bowl & lid

Sucrier & couvercle
Zuckerdose & Deckel
Azucarero & tapa

FDSU22 22 cl / 7 7/16 oz
 6

Lid for sugar bowl

Couvercle pour sucrier
Deckel für Zuckerdose
Tapa para azucarero

FDSULD
 12



Pepper shaker

Poivrier
Pfefferstreuer
Pimentero

FDPS01
 6



Salt shaker

Salière
Salzstreuer
Salero

FDSS01
 6

Pieces per box
Pièces par boîte
Stück pro Karton
Piezas por caja

Stored in Europe
Entreposé en Europe
In Europa gelagert
Almacendo en Europa





Design Mikaela Dörfel





LYRA

En Lyra's natural elegance, poise and grace are ideally suited for harmoniously displaying diverse dishes. Its arched silhouette and graceful line reveal a bearing that dresses up any table.

De Die natürliche Eleganz und Anmut der Kollektion Lyra ermöglichen ein harmonisches Anrichten der verschiedenen Speisen. Mit der gerundeten Silhouette und der graziösen Linie macht die Kollektion auf jedem Tisch eine gute Figur.

Fr L'élégance naturelle de Lyra, sa tenue et sa grâce permettent une présentation harmonieuse de mets variés. Avec sa silhouette galbée et sa ligne gracieuse, elle dévoile une prestance qui habille chaque table.

Es La elegancia natural de Lyra, su porte y su gracia permiten presentar platos variados con armonía. Con su silueta claramente perfilada y su elegante línea, desvela una prestantia que viste la mesa.



LYRA COLLECTION



Flat plate

Assiette plate
Teller flach
Plato llano

LRFP31 31 cm / 12 3/16"
 6

LRFP29 29 cm / 11 7/16"
LRFP27 27 cm / 10 10/16"
LRFP24 24 cm / 9 7/16"
LRFP21 21 cm / 8 4/16"

12

LRFP19 19 cm / 7 8/16"
 24

LRFP17 17 cm / 6 11/16"
LRFP15 15 cm / 5 14/16"
 24



Deep plate

Assiette creuse
Teller tief
Plato hondo

LRDP30 30 cm / 11 13/16"
 6

LRDP26 26 cm / 10 4/16"
LRDP23 23 cm / 9 1/16"

12



Tajine cover for deep plate

Couvercle tajine
pour assiette creuse
Tajine Deckel für tiefe Teller
Tapa tajine para plato hondo

LRCV27 > LRDP30
LRCV23 > LRDP26
LRCV20 > LRDP23

1



Oval platter

Plat ovale
Platte oval
Fuente oval

LROP38 38 x 27 cm
14 15/16 x 10 10/16"

LROP32 32 x 22,5 cm
12 10/16 x 8 14/16"

6

LROP22 22 x 15,5 cm
8 11/16" x 6 2/16"

12



Stackable salad bowl

Saladier empilable
Salatschale stapelbar
Ensaladera apilable

LRSB18 18 cm - 29 cl
7 1/16" - 9 13/16 oz

12

LRSB12 12 cm - 15 cl
4 12/16" - 5 1/16 oz

12



Non stackable soup bowl

Tasse bouillon non empilable
Suppentasse nicht stapelbar
Bol consommé no apilable

LRCN30 30 cl / 10 2/16 oz
 12



Stackable soup bowl

Tasse bouillon empilable
Suppentasse stapelbar
Bol consommé apilable

LRCS30 30 cl / 10 2/16 oz
 12



Non-stackable cup

Tasse non empilable
Tasse nicht stapelbar
Taza no apilable

LRCU27 27 cl / 9 2/16 oz
LRCU22 22 cl / 7 7/16 oz
LRCU18 18 cl / 6 1/16 oz
LRCU09 9 cl / 3 1/16 oz

12



Stackable cup

Tasse empilable
Tasse stapelbar
Taza apilable

LRSC27 27 cl / 9 2/16 oz
LRSC22 22 cl / 7 7/16 oz
LRSC18 18 cl / 6 1/16 oz
LRSC09 9 cl / 3 1/16 oz

12



Saucer

Soucoupe
Untertasse
Platillo

LRSA17 > LRCU27 / LRSC27
LRCS30 / LRCN30

17 cm / 6 11/16"

12

**Saucer**

Soucoupe
Untertasse
Platillo

LRSA15 > LRCU22 / LRCU18
LRSC22 / LRSC18

15 cm / 5 14/16"

LRSA12 > LRCU09 / LRSC09

12 cm / 4 12/16"

**Sugar bowl & lid**

Sucrier & couvercle
Zuckerdose & Deckel
Azucarero & tapa

LRSU27 27 cl / 9 2/16 oz

**Lid for sugar bowl**

Couvercle pour sucrier
Deckel für Zuckerdose
Tapa para azucarero

LRSULD

**Creamer**

Crémier
Milchkännchen
Lechera

LRCR25 25 cl / 8 7/16 oz



LRCR15 15 cl / 5 1/16 oz

**Coffee pot & lid**

Cafetière & couvercle
Kaffeekanne & Deckel
Cafetera & tapa

LRCP35 35 cl / 11 13/16 oz

**Lid for coffee pot**

Couvercle pour cafetière
Deckel für Kaffeekanne
Tapa para cafetera

LRCLD

**Teapot & lid**

Théière & couvercle
Teekanne & Deckel
Tetera & tapa

LRTP40 40 cl / 13 8/16 oz

**Lid for teapot**

Couvercle pour théière
Deckel für Teekanne
Tapa para tetera

LRTPLD

**Egg cup**

Coquetier
Eierbecher
Huevera

LREG01

**Salt shaker**

Salière
Salzstreuer
Salero

LRSS01

**Pepper shaker**

Poivrier
Pfefferstreuer
Pimentero

LRPS01

**Flower vase**

Vase
Blumenvase
Florero

LRFV01







CLASSIC GOURMET

En With its range of square, round or rectangular shapes, Classic Gourmet has unlimited use for all contemporary culinary styles of gastronomy. With its timeless chic, ease of handling and extreme strength, Classic Gourmet is a must for any professional.

Fr Grâce à l'éventail de ses formes carrées, rondes ou rectangulaires, Classic Gourmet permet une utilisation illimitée pour tous les styles culinaires de la gastronomie contemporaine. Avec un chic intemporel, une facilité de manipulation et une résistance extrême, Classic Gourmet séduit tous les professionnels.

De Dank des großen Spektrums an quadratischen, runden und rechteckigen Formen ermöglicht die Kollektion Classic Gourmet einen praktisch grenzenlosen Einsatz für sämtliche kulinarische Stile der zeitgenössischen Küche. Mit ihrem zeitlosen Chic, der einfachen Handhabung und einer extremen Langlebigkeit überzeugt Classic Gourmet alle Profis aus der Gastronomie.

Es Gracias a la variedad de sus formas cuadradas, redondas o rectangulares, Classic Gourmet puede utilizarse de forma ilimitada para todos los estilos culinarios de la gastronomía contemporánea. Por su elegancia atemporal, una fácil manipulación y una resistencia extrema, Classic Gourmet seduce a todos los profesionales.



CLASSIC GOURMET COLLECTION



Rectangular flat plate

Assiette plate rectangulaire
Teller flach rechteckig
Plato llano rectangular

CLRP38 38 x 21 cm

14 15/16 x 8 4/16"

CLRP33 33 x 23 cm / 13 x 9 1/16"



CLRP29 29 x 12 cm

11 7/16 x 4 12/16"

CLRP26 26 x 8 cm

10 4/16 x 3 2/16"

CLRP23 23 x 7 cm

9 1/16 x 2 12/16"



CLRP21 21 x 7 cm

8 4/16 x 2 12/16"



Square flat plate

Assiette plate carrée
Teller flach quadratisch
Plato llano cuadrado

CLSP30 30 cm / 11 13/16"



CLSP27 27 cm / 10 10/16"

CLSP24 24 cm / 9 7/16"



Round flat plate

Assiette plate ronde
Teller flach rund
Plato llano redondo

CLFP33 33 cm / 13"

CLFP31 31 cm / 12 3/16"



CLFP29 29 cm / 11 7/16"

CLFP27 27 cm / 10 10/16"

CLFP24 24 cm / 9 7/16"



CLFP21 21 cm / 8 4/16"

CLFP19 19 cm / 7 8/16"

CLFP17 17 cm / 6 11/16"

CLFP15 15 cm / 5 14/16"



Round deep plate

Assiette creuse ronde
Teller tief rund
Plato hondo redondo

CLDP30 30 cm / 11 13/16"



CLDP26 26 cm / 10 4/16"

CLDP24 24 cm / 9 7/16"



Extra deep round plate

Assiette extra creuse ronde
Teller extra tief rund
Plato extra hondo redondo

CLXD26 26 cm / 10 4/16"

CLXD23 23 cm / 9 1/16"



Square salad bowl

Saladier carré
Salatschale quadratisch
Ensaladera cuadrado

CLSB21 21 cm - 4,5 cm

8 4/16" - 1 12/16"



CLSB18 18 cm - 4,5 cm

7 1/16" - 1 12/16"

CLSB16 16 cm - 4,5 cm

6 5/16" - 1 12/16"

CLSB14 14 cm - 4,5 cm

5 8/16" - 1 12/16"

CLSB12 12 cm - 4,5 cm

4 12/16" - 1 12/16"



Cream soup bowl with 2 handles

Tasse bouillon avec 2 anses
Suppentasse mit 2 Henkel
Bol consomé con 2 asas

CLCS30 10,5 cm - 6 cm - 30 cl

4 2/16" - 2 6/16" - 10 2/16 oz



**Non stackable cup**

Tasse non empilable
Tasse nicht stapelbar
Taza no apilable

CLCU28 28 cl / 9 7/16 oz

CLCU23 23 cl / 7 12/16 oz

CLCU20 20 cl / 6 12/16 oz

CLCU09 9 cl / 3 1/16 oz

**Stackable cup**

Tasse empilable
Tasse stapelbar
Taza apilable

CLSC23 23 cl / 7 12/16 oz

CLSC20 20 cl / 6 12/16 oz

CLSC09 9 cl / 3 1/16 oz

**Saucer for cup**

Soucoupe pour tasse
Untere für Tasse
Platillo para taza

CLSA17 > CLCU28

17 cm / 6 11/16"

CLSA15 > CLSC(CU)20 / CLSC(CU)23

15 cm / 5 14/16"

CLSA13 > CLSC09 / CLCU09

12,5 cm / 4 15/16"

**Coffee pot & lid**

Cafetière & couvercle
Kaffeekanne & Deckel
Cafetera & tapa

CLCP35 35 cl / 11 13/16 oz

**Lid for coffee pot**

Couvercle pour cafetière
Deckel für Kaffeekanne
Tapa para cafetera

CLCLD1

**Teapot & lid**

Théière & couvercle
Teekanne & Deckel
Tetera & tapa

CLTP40 40 cl / 13 8/16 oz

**Lid for teapot**

Couvercle pour théière
Deckel für Teekanne
Tapa para tetera

CLTP40LD

**Creamer**

Crémier
Milchkännchen
Lechera

CLCR25 25 cl / 8 7/16 oz

CLCR15 15 cl / 5 1/16 oz

**Sugar bowl & lid**

Sucrier & couvercle
Zuckerdose & Deckel
Azucarero & tapa

CLSU27 27 cl / 9 2/16 oz

**Lid for sugar bowl**

Couvercle pour sucrier
Deckel für Zuckerdose
Tapa para azucarero

CLSULD

**Salt shaker**

Salière
Salzstreuer
Salero

CLSS01

**Pepper shaker**

Poivrier
Pfefferstreuer
Pimentero

CLPS01







PLAYA

En Just like the infinity of sea and sandy beaches, the Playa product line is an invitation to exoticism and freedom. On a background of bright white porcelain, your dishes will stand out and your creativity will be highlighted with an unmatched aesthetic.

Fr Tel l'infini de la mer et des plages de sable fin, la gamme Playa vous invite à l'exotisme et à la liberté. Sur un fond de porcelaine d'un blanc éclatant, vos plats sont mis en relief et votre créativité mise en lumière avec une esthétique sans nulle autre pareille.

De Die Kollektion Playa weckt Assoziationen von Exotik und Freiheit wie das weite Meer und kilometerlange feine Sandstrände. Auf einer Grundlage aus strahlend weißem Porzellan kommen Ihre Gerichte und Ihre Kreativität besonders gut zur Geltung und strahlen eine unvergleichliche Ästhetik aus.

Es Como el infinito del mar y las costas de arena fina, la gama Playa invita al exotismo y a la libertad. Sobre un fondo de porcelana de un blanco resplandeciente, se realzan los manjares y se potencia la creatividad con una estética sin parangón.



PLAYA COLLECTION



Rectangular flat plate

Assiette plate rectangulaire
Teller flach rechteckig
Plato llano rectangular

PLRP38 38 x 21 cm / 14 15/16 x 8 4/16"

PLRP33 33 x 23 cm / 13 x 9 1/16"



PLRP29 29 x 12 cm / 11 7/16 x 4 12/16"

PLRP26 26 x 8 cm / 10 4/16 x 3 2/16"

PLRP23 23 x 7 cm / 9 1/16 x 2 12/16"



Square flat plate

Assiette plate carrée
Teller flach quadratisch
Plato llano cuadrado

PLSP30 30 cm / 11 13/16"



PLSP27 27 cm / 10 10/16"

PLSP24 24 cm / 9 7/16"



Round flat plate

Assiette plate ronde
Teller flach rund
Plato llano redondo

PLFP31 31 cm / 12 3/16"



PLFP29 29 cm / 11 7/16"

PLFP27 27 cm / 10 10/16"

PLFP24 24 cm / 9 7/16"



PLFP21 21 cm / 8 4/16"

PLFP17 17 cm / 6 11/16"

PLFP15 15 cm / 5 14/16"



Round deep plate

Assiette creuse ronde
Teller tief rund
Plato hondo redondo

PLDP30 30 cm / 11 13/16"



PLDP24 24 cm / 9 7/16"



Non stackable cup (Classic Gourmet)

Tasse non empilable (Classic Gourmet)

Tasse nicht stapelbar (Classic Gourmet)

Taza no apilable (Classic Gourmet)

CLCU28 28 cl / 9 7/16 oz



Saucer

Soucoupe

Untertasse

Platillo

PLSA17 > CLCU28

17 cm / 6 11/16"



Non stackable cup (Classic Gourmet)

Tasse non empilable (Classic Gourmet)

Tasse nicht stapelbar (Classic Gourmet)

Taza no apilable (Classic Gourmet)

CLCU23 23 cl / 7 12/16 oz

CLCU20 20 cl / 6 12/16 oz



Saucer

Soucoupe

Untertasse

Platillo

PLSA15 > CLCU23 / CLCU20

15 cm / 5 14/16"



Non stackable cup (Classic Gourmet)

Tasse non empilable (Classic Gourmet)

Tasse nicht stapelbar (Classic Gourmet)

Taza no apilable (Classic Gourmet)

CLCU09 9 cl / 3 1/16 oz



Saucer

Soucoupe

Untertasse

Platillo

PLSA13 > CLCU09

13 cm / 5 2/16"









LINE-Z

En To “stage” your dishes, the Line-Z streaks create an extraordinary visual effect with concentric circles on bright porcelain. Use Line-Z to showcase your unique creations for a spectacular presentation.

De Die Riffelung der Kollektion Line-Z erzeugt einen außergewöhnlichen optischen Effekt konzentrischer Kreise auf brillantweißem Porzellan und rückt Ihre Speisen so ins perfekte Licht. Line-Z ist die ideale Verpackung einzigartiger Kreationen in einer spektakulären Form.

Fr Pour mettre en scène vos plats, les stries de Line-Z créent un effet visuel extraordinaire avec des cercles concentriques sur une porcelaine éclatante. Laissez Line-Z servir d’écran à vos créations uniques pour une présentation spectaculaire.

Es Para la puesta en escena de sus platos, las estrías de Line-Z crean un extraordinario efecto visual con círculos concéntricos sobre una porcelana resplandeciente. Permita que Line-Z sirva de marco para sus creaciones únicas, con una presentación espectacular.



LINE-Z COLLECTION



Rectangular flat plate
Assiette plate rectangulaire
Teller flach rechteckig
Plato llano rectangular

LZRP33 33 x 23 cm
13 x 9 1/16"



LZRP29 29 x 10 cm
11 7/16" x 3 15/16"



LZRP26 26 x 8 cm
10 4/16" x 3 2/16"



Square flat plate
Assiette plate carrée
Teller flach quadratisch
Plato llano cuadrado

LZSP30 30 cm / 11 13/16"



Round flat plate
Assiette plate ronde
Teller flach rund
Plato llano redondo

LZFP31 31 cm / 12 3/16"



LZFP27 27 cm / 10 10/16"

LZFP24 24 cm / 9 7/16"



LZFP21 21 cm / 8 4/16"

LZFP17 17 cm / 6 11/16"



LZFP15 15 cm / 5 14/16"



Round deep plate
Assiette creuse ronde
Teller tief rund
Plato hondo redondo

LZDP30 30 cm / 11 13/16"



LZDP24 24 cm / 9 7/16"



Non stackable cup (Classic Gourmet)

Tasse non empilable (Classic Gourmet)

Tasse nicht stapelbar (Classic Gourmet)

Taza no apilable (Classic Gourmet)

CLCU28 28 cl / 9 7/16 oz



Saucer

Soucoupe

Untertasse

Platillo

LZSA17 > CLCU28

17 cm / 6 11/16"



Non stackable cup (Classic Gourmet)

Tasse non empilable (Classic Gourmet)

Tasse nicht stapelbar (Classic Gourmet)

Taza no apilable (Classic Gourmet)

CLCU23 23 cl / 7 12/16 oz

CLCU20 20 cl / 6 12/16 oz



Saucer

Soucoupe

Untertasse

Platillo

LZSA15 > CLCU23 / CLCU20

15 cm / 5 14/16"



Non stackable cup (Classic Gourmet)

Tasse non empilable (Classic Gourmet)

Tasse nicht stapelbar (Classic Gourmet)

Taza no apilable (Classic Gourmet)

CLCU09 9 cl / 3 1/16 oz



Saucer

Soucoupe

Untertasse

Platillo

LZSA13 > CLCU09

13 cm / 5 2/16"









SKA

En The round and square shapes of the Ska product line offer a perfect platform for a number of culinary uses. Specifically created to be used in collective and commercial catering, the Ska product line enjoys unfailing solidity and is stackable at leisure.

De Die runden und eckigen Formen der Kollektion Ska sind die ideale Grundlage für einen vielfältigen gastronomischen Einsatz. Die Kollektion Ska ist für den Einsatz in der Großgastronomie konzipiert und besonders bruchfest sowie hervorragend stapelbar.

Fr Les formes rondes et carrées de la gamme Ska tissent un support parfait pour une utilisation culinaire multiple. Réalisée pour un usage en restauration collective et commerciale, la gamme Ska est dotée d'une solidité à toute épreuve, empilable à loisir.

Es Las formas redondas y cuadradas de la gama Ska tejen un soporte perfecto para un uso culinario múltiple. Realizada para su uso en restauración colectiva y comercial, la gama Ska está dotada de una solidez a toda prueba y es apilable con toda tranquilidad.



SKA COLLECTION



Square flat plate

Assiette plate carrée
Teller flach quadratisch
Plato llano cuadrado

SKSFP31 31 cm / 12 3/16"



SKSFP27 27 cm / 10 10/16"

SKSFP24 24 cm / 9 7/16"

SKSFP21 21 cm / 8 4/16"



SKSFP19 19 cm / 7 8/16"

SKSFP17 17 cm / 6 11/16"

SKSFP14 14 cm / 5 8/16"



Square deep plate

Assiette creuse carrée
Teller tief quadratisch
Plato hondo cuadrado

SKSDP27 27 cm / 10 10/16"

SKSDP24 24 cm / 9 7/16"

SKSDP21 21 cm / 8 4/16"



SKSDP15 15 cm / 5 14/16"



SKSDP14 14 cm / 5 8/16"



Round narrow rim flat plate

Assiette ronde plate coupe
Teller rund flach coupe
Plato llano redondo coupe

SKRFP28 28 cm / 11"

SKRFP24 24 cm / 9 7/16"

SKRFP22 22 cm / 8 11/16"



SKRFP19 19 cm / 7 8/16"

SKRFP16 16 cm / 6 5/16"



Round narrow rim deep plate

Assiette ronde creuse coupe
Teller rund tief coupe
Plato redondo hondo coupe

SKRDP26 26 cm / 10 4/16"

SKRDP22 22 cm / 8 11/16"



Steak plate

Assiette à steak
Steakteller
Plato steak

SKRP30 30 x 20 cm / 11 13/16 x 7 14/16"



Round bowl

Bol rond
Schale rund
Bol redondo

SKBWL23 23 cm - 100 cl

9 1/16" - 33 13/16 oz



SKBWL17 17 cm - 45 cl

6 11/16" - 15 3/16 oz



Square round dish

Ravier rond carré
Schale rund quadratisch
Bol cuadrado redondo

SKSRD16 16 cm - 30 cl

6 5/16" - 10 2/16 oz

SKSRD14 14 cm - 25 cl

5 8/16" - 8 7/16 oz

SKSRD12 12 cm - 18 cl

4 12/16" - 6 1/16 oz

SKSRD11 11 cm - 10 cl

3 15/16" - 3 6/16 oz

SKSRD10 10 cm - 7,5 cl

3 15/16" - 2 9/16 oz



Rectangular dish

Ravier rectangulaire
Schale rechteckig
Rabanera rectangular

SKRTD15 15 x 10 cm - 22 cl

5 14/16 x 3 15/16" - 7 7/16 oz



Square dish

Ravier carré
Schale quadratisch
Rabanera cuadrada

SKSTD11 11 x 11 cm - 21 cl

4 5/16 x 4 5/16" - 7 2/16 oz



**Bowl stackable**

Bol empilable
Schale stapelbar
Bol apilable

SKBWL60 15 cm - 60 cl
5 14/16" - 20 5/16 oz

SKBWL40 13 cm - 40 cl
5 2/16" - 13 8/16 oz

**Cream soup bowl 2 handles**

Tasse bouillon 2 anses
Suppentasse 2 Henkel
Bol consommé 2 asas

SKCS30 10 cm - 30 cl
3 15/16" - 10 2/16 oz

**Breakfast cup**

Tasse à déjeuner
Frühstückstasse
Taza de desayuno

SKCU30 30 cl / 10 2/16 oz

**Saucer for breakfast cup & cream soup bowl**

Soucoupe pour tasse à déjeuner
& tasse bouillon
Untere für Frühstückstasse
& Suppentasse
Platillo para taza de desayuno
& bol consommé

SKSA16 16 cm / 6 5/16"

**Tea/coffee cup**

Tasse à thé/café
Tee/Kaffeetasse
Taza a té/café

SKCU23 23 cl / 7 12/16 oz

SKCU17 17 cl / 5 12/16 oz

**Saucer for tea/coffee cup**

Soucoupe pour tasse à thé/café
Untere für Tee/Kaffeetasse
Platillo para taza a té/café

SKSA14 14 cm / 5 8/16"

**Espresso Cup**

Tasse à expresso
Espressotasse
Taza a expresso

SKCU09 9 cl / 3 1/16 oz

**Saucer for espresso cup**

Soucoupe pour tasse à expresso
Untere für Espressotasse
Platillo para taza a expresso

SKSA12 12 cm / 4 12/16"

**Stackable mug**

Chope empilable
Becher stapelbar
Mug apilable

SKSM30 30 cl / 10 2/16 oz

**Mug**

Chope
Becher
Mug

SKMG22 22 cl / 7 7/16 oz



 Pieces per box
Pièces par boîte
Stück pro Karton
Piezas por caja

 Stored in Europe
Entreposé en Europe
In Europa gelagert
Almacendo en Europa



SKA COLLECTION



Coffee pot & lid

Cafetière & couvercle
Kaffeekanne & Deckel
Cafetera & tapa

SKCP70 70 cl / 23 11/16 oz



SKCP35 35 cl / 11 13/16 oz



Lid for coffee pot

Couvercle pour cafetière
Deckel für Kaffeekanne
Tapa para cafetera

SKCPLD2 > SKCP70



SKCPLD > SKCP35



Teapot & lid

Théière & couvercle
Kaffeekanne & Deckel
Tetera & tapa

SKTP80 80 cl / 27 1/16 oz



SKTP40 40 cl / 13 8/16 oz



Lid for teapot

Couvercle pour théière
Deckel für Teekanne
Tapa para tetera

SKTPLD2 > SKTP80



SKTPLD > SKTP40



Creamer

Crémier
Milchkännchen
Lechera

SKCR15 15 cl / 5 1/16 oz



Small creamer

Crémier petit
Milchkännchen
Lechera pequeña

103JG02 2 cl / 11/16 oz



Sugar holder

Sucrier
Zuckerdose
Azucarero

SKSH23 23 cl / 7 12/16 oz



Sugar bowl & lid

Sucrier & couvercle
Zuckerdose & Deckel
Azucarero & tapa



SKSU25 25 cl / 8 7/16 oz

Lid for sugar bowl

Couvercle pour sucrier
Deckel für Zuckerdose
Tapa para azucarero

SKSULD



Pepper shaker

Poivrier
Pfefferstreuer
Pimentero

SKPS01



Salt shaker

Salière
Salzstreuer
Salero

SKSS01



Toothpick holder

Conteneur cure-dents
Zahnstocherhalter
Palillero

SKTH01









BANQUET

En Ideal for all environments, the Banquet collection consists of over 100 items for professionals and caters to the diversity of their daily needs. This collection perfectly associates functionality, robustness and minimalist elegance.

Fr Idéale pour tous les environnements, la collection Banquet se compose de plus de 100 pièces pour les professionnels et la variété de leurs besoins quotidiens. Cette collection associe à merveille fonctionnalité, robustesse et élégance minimaliste.

De Die Kollektion Banquet ist universell einsetzbar und dank der über 100 unterschiedlichen Teile ideal für den professionellen Gebrauch mit häufig wechselnden Anforderungen. Die Kollektion besticht durch hervorragende Funktionalität, Robustheit und minimalistische Eleganz.

Es La colección Banquet es ideal para todos los ambientes. Está compuesta por más de 100 piezas para profesionales y para todas sus necesidades diarias. Esta colección conjuga a las mil maravillas funcionalidad, solidez y elegancia minimalista.



BANQUET COLLECTION



Flat plate

Assiette plate
Teller flach
Plato llano

BAFP31 31 cm / 12 3/16"
BAFP30 30 cm / 11 13/16"



BAFP29 29 cm / 11 7/16"
BAFP27 27 cm / 10 10/16"
BAFP25 25 cm / 9 13/16"
BAFP24 24 cm / 9 7/16"
BAFP23 23 cm / 9 1/16"



BAFP21 21 cm / 8 4/16"
BAFP20 20 cm / 7 14/16"
BAFP19 19 cm / 7 8/16"
BAFP17 17 cm / 6 11/16"
BAFP15 15 cm / 5 14/16"
BAFP13 13 cm / 5 2/16"



Deep plate

Assiette creuse
Teller tief
Plato hondo

BADP30 30 cm / 11 13/16"



BADP26 26 cm / 10 4/16"
BADP23 23 cm / 9 1/16"
BADP19 19 cm / 7 8/16"



Steak plate

Assiette à steak
Steakteller
Plato steak

BAOP30 30 x 25,5 cm
11 13/16" x 10 1/16"



Pizza plate

Assiette à pizza
Pizzateller
Plato pizza

BAPP33 33 cm / 13"
BAPP32 30,5 cm / 12"



Oval plate

Plat ovale
Platte oval
Fuente oval

BAOP45 45 x 33 cm / 17 11/16 x 13"



BAOP38 38 x 26 cm / 14 15/16 x 10 4/16"
BAOP32 32 cm / 12 10/16"



BAOP26 26 cm / 10 4/16"
BAOP22 22 x 15,5 cm / 8 11/16 x 6 2/16"



Bowl

Bol
Schale
Bol

BABW14 14 cm - 6 cm - 63 cl
5 8/16" - 2 6/16" - 21 5/16 oz

BABW12 12 cm - 6 cm - 48 cl
4 12/16" - 2 6/16" - 16 4/16 oz



BACS01 10 cm - 30 cl
3 15/16" - 10 2/16 oz



Lugged soup bowl

Tasse bouillon
Suppentasse
Bol consommé

BACS02 30 cl / 10 2/16 oz



Cream soup bowl 2 handles

Tasse bouillon 2 anses
Suppentasse 2 Henkel
Bol consommé 2 asas

BACS30 30 cl / 10 2/16 oz

BACS18 18 cl / 6 1/16 oz



Saucer

Soucoupe
Untertasse
Platillo

BAST01 > **BACS30** / **BASB12** / **BACU28**
17 cm / 6 11/16"



**Salad bowl stackable**

Saladier empilable
Salatschale stapelbar
Ensaladera apilable

BASB21 21 cm - 118 cl
8 4/16" - 39 14/16 oz

BASB18 18 cm - 72 cl
7 1/16" - 24 6/16 oz

BASB16 16 cm - 60 cl
6 5/16" - 20 5/16 oz

BASB12 12 cm - 25 cl
4 12/16" - 8 7/16 oz

**Salad bowl**

Saladier
Salatschale
Ensaladera

BASP31 31 cm - 590 cl
12 3/16" - 199 8/16 oz



BASP25 25 cm - 200 cl
9 13/16" - 67 10/16 oz



BASP20 20 cm - 105 cl
7 14/16" - 35 8/16 oz

BASP16 16 cm - 67 cl
6 5/16" - 22 10/16 oz

BASP14 14 cm - 60 cl
5 8/16" - 20 5/16 oz

BASP12 12 cm - 31 cl
4 12/16" - 10 8/16 oz

**Mezza bowl big**

Plat mezze grand
Mezza Schale groß
Bol mezza grande

BAMB17 17 cm - 36 cl
6 11/16" - 12 3/16 oz

**Mezza bowl small**

Plat mezze petit
Mezza Schale klein
Bol mezza pequeño

BAMB13 13 cm - 17 cl
5 2/16" - 5 12/16 oz

**Noodle bowl**

Bol à nouilles
Nudelschale
Bol a tallarines

BANB21 21 cm - 110 cl
8 4/16" - 37 3/16 oz

**Arabic cup**

Tasse arabe
Tasse arabisch
Taza árabiga

BAAC16 16 cl / 5 7/16 oz

BAAC11 11 cl / 3 12/16 oz

BAAC06 6 cl / 2 oz

**Non stackable round cup**

Tasse ronde non empilable
Tasse rund nicht stapelbar
Taza redonda no apilable

BANC28 28 cl / 9 7/16 oz

BANC22 22 cl / 7 7/16 oz

BANC15 15 cl / 5 1/16 oz

**Saucer**

Soucoupe
Untertasse
Platillo

BASA15 > BANC28 / BANC22 / BANC15
15 cm / 5 14/16"



Pieces per box
Pièces par boîte
Stück pro Karton
Piezas por caja

Stored in Europe
Entreposé en Europe
In Europa gelagert
Almacendo en Europa



BANQUET COLLECTION



Non stackable round cup
Tasse ronde non empilable
Tasse rund nicht stapelbar
Taza redonda no apilable

BANC09 9 cl / 3 1/16 oz



Saucer
Soucoupe
Untertasse
Platillo

BASA13 > BANC09
13 cm / 5 2/16"



Stackable cup
Tasse empilable
Tasse stapelbar
Taza apilable

BACU28 28 cl / 9 7/16 oz
BACU23 23 cl / 7 12/16 oz
BACU20 20 cl / 6 12/16 oz
BACU18 18 cl / 6 1/16 oz



Saucer
Soucoupe
Untertasse
Platillo

**BASA15 > BACU28 / BACU23
BACU20 / BACU18**
15 cm / 5 14/16"



Stackable cup
Tasse empilable
Tasse stapelbar
Taza apilable

BACU09 9 cl / 3 1/16 oz



Saucer
Soucoupe
Untertasse
Platillo

BASA13 > BACU09
13 cm / 5 2/16"



Mug
Chope
Becher
Mug

BAMG45 45 cl / 15 3/16 oz
BAMG36 36 cl / 12 3/16 oz



Mug Flora
Chope Flora
Becher Flora
Mug Flora

BAFMG36 36 cl / 12 3/16 oz

BAFMG30 30 cl / 10 2/16 oz
BAMG26 26 cl / 8 13/16 oz



Mug stackable
Chope empilable
Becher stapelbar
Mug apilable

BASM30 30 cl / 10 2/16 oz



Mug Tulip
Chope Tulip
Becher Tulip
Mug Tulip

BATMG45 45 cl / 15 3/16 oz



Coffee pot & lid
Cafetière & couvercle
Kaffeekanne & Deckel
Cafetera & tapa

BACP70 70 cl / 23 11/16 oz
BACP35 35 cl / 11 13/16 oz

Lid for coffee pot
Couvercle pour cafetière
Deckel für Kaffeekanne
Tapa para cafetera

**BACPLD2 > BACP70
BACPLD1 > BACP35**

**Teapot & lid**

Théière & couvercle
Teekanne & Deckel
Tetera & tapa

BATP100 100 cl / 33 13/16 oz



BATP80 80 cl / 27 1/16 oz

BATP40 40 cl / 13 8/16 oz

**Lid for teapot**

Couvercle pour théière
Deckel für Teekanne
Tapa para tetera

BATPLD2 > BATP80

BATPLD1 > BATP40

**Creamer**

Crémier
Milchkännchen
Lechera

BACR35 35 cl / 11 13/16 oz

BACR25 25 cl / 8 7/16 oz

BACR15 15 cl / 5 1/16 oz



BACR05 5 cl / 1 11/16 oz

**Gravy boat**

Saucière
Sauciere
Salsera

BAGB35 35 cl / 11 13/16 oz

**Saucer**

Soucoupe
Untertasse
Platillo

BASA15 > BAGB15

15 cm / 5 14/16"

**Gravy boat**

Saucière
Sauciere
Salsera

BAGB15 15 cl / 5 1/16 oz

**Saucer**

Soucoupe
Untertasse
Platillo

BASA13 > BAGB15

13 cm / 5 2/16"

**Stackable butter ramekin**

Ramequin beurre empilable
Butterschälchen stapelbar
Cuenco para mantequilla apilable

BABR03

7 cm - 6 cl / 2 12/16" - 2 oz

**Butter ramekin**

Ramequin beurre
Butterschälchen
Cuenco para mantequilla

BABR02 8 cm - 10 cl / 3 2/16" - 3 6/16 oz

BABR01 7 cm - 6 cl / 2 12/16" - 2 oz

**Butter dish**

Assiette à beurre
Butterteller
Plato mantequilla

BABD11 11 x 8 cm / 4 5/16 x 3 2/16"

**Continental sauce dish**

Plat à sauce continental
Saucenschale continental
Salsera continental

BACD09 9 x 7 cm / 3 9/16 x 2 12/16"

**Pepper shaker**

Poivrier
Pfefferstreuer
Pimentero

BAPS01





BANQUET COLLECTION



Salt shaker

Salière
Salzstreuer
Salero

BASS01



Sumek shaker

Salière Sumek
Sumekstreuer
Salero Sumek

BASM01



Egg cup

Coquetier
Eierbecher
Huevera

BAEG01



Sugar bowl & lid

Sucrier & couvercle
Zuckerdose & Deckel
Azucarero & tapa

BASU27 27 cl / 9 2/16 oz



Lid for sugar bowl

Couvercle pour sucrier
Deckel für Zuckerdose
Tapa para azucarero

BASULD



Sugarpack holder sliding

Sucrier oblique pour dosettes
Zuckertütenschale schräg
Azucarero sobres oblicuo

BASH03 11 x 6 x 5 cm - 10 cl
4 5/16 x 2 6/16 x 1 15/16" -
3 6/16 oz



Sugarpack holder

Sucrier à sachets
Zuckertütenschale
Azucarero sobres

BASH01 9 x 3 x 2 cm - 20 cl

3 9/16 x 1 3/16 x 13/16" -
6 12/16 oz



Sugarpack holder round

Sucrier rond à sachets
Zuckertütenschale rund
Azucarero sobres redondo

BASH02 8,5 cm - 23 cl

3 6/16" - 7 12/16 oz



Toothpick holder

Conteneur cure-dents
Zahnstocherhalter
Palillero

BATH01 7 cl - 2 6/16 oz



Menu label holder

Porte menu
Menühalter
Soporte menú

BAMH01



Napkin holder

Porte serviette
Serviettenhalter
Servilletero

BANH01



Napkin ring

Anneau à serviette
Serviettenring
Anillo servilletero

BANR01 6 cm / 2 6/16"





Flower vase

Vase

Vase

Florero

BAFV01 12 cm / 4 12/16"



Cigar ashtray

Cendrier à cigares

Zigarrenascher

Cenicero puros

BACA01 21 x 16 cm

8 4/16 x 6 5/16"



Ashtray

Cendrier

Ascher

Cenicero

BAAT01 11 cm / 4 5/16"



 Pieces per box
Pièces par boîte
Stück pro Karton
Piezas por caja

 Stored in Europe
Entreposé en Europe
In Europa gelagert
Almacendo en Europa





RONDO

En With exquisite gentle, rounded shallow or flat lines, Rondo enhances your culinary creations to perfection. Rondo, like a dance, offers complete freedom to flavour blending.

De Mit einer dezenten und runden, sanften Liniensprache stellt die Kollektion Rondo Ihre kulinarischen Kreationen in den Mittelpunkt. Tänzerisch leicht bietet Rondo der Geschmacksvielfalt uneingeschränkte Freiheit.

Fr Avec d'exquises lignes arrondies tout en douceur, creuses ou plates, Rondo valorise vos créations culinaires à merveille. Rondo, telle une danse, offre une liberté totale au mélange des saveurs.

Es Gracias a sus exquisitas líneas redondeadas con la máxima suavidad, las fuentes de Rondo, ya sean hondas o llanas, destacan de maravilla las creaciones culinarias. Como una danza, Rondo ofrece total libertad para la mezcla de sabores.



RONDO COLLECTION



Flat plate

Assiette plate
Teller flach
Plato llano

BAFP31D7 31 cm / 12 3/16"

BAFP29D7 29 cm / 11 7/16"

BAFP27D7 27 cm / 10 10/16"

BAFP24D7 24 cm / 9 7/16"

BAFP21D7 21 cm / 8 4/16"

BAFP19D7 19 cm / 7 8/16"

BAFP17D7 17 cm / 6 11/16"

BAFP15D7 15 cm / 5 14/16"



Deep plate

Assiette creuse
Teller tief
Plato hondo

BADP30D7 30 cm / 11 13/16"

BADP23D7 23 cm / 9 1/16"



Oval platter

Plat ovale
Platte oval
Fuente oval

BAOP38D7 38 cm / 14 15/16"

BAOP32D7 32 cm / 12 10/16"



Cream soup bowl 2 handles

Tasse bouillon 2 anses
Suppentasse 2 Henkel
Bol consommé 2 asas

BACS30D7 30 cl / 10 2/16 oz

BACS18D7 18 cl / 7 1/16 oz



Saucer

Soucoupe
Untertasse
Platillo

BAST01D7 > BACS30D7

17 cm / 6 11/16"



Salad bowl

Saladier
Salatschale
Ensaladera

BASP16D7 16 cm - 67 cl
6 5/16" - 22 10/16 oz



Salad bowl stackable

Saladier empilable
Salatschale stapelbar
Ensaladera apilable

BASB16D7 16 cm - 60 cl

6 5/16" - 20 5/16 oz



Cup stackable

Tasse empilable
Tasse stapelbar
Taza apilable

BACU23D7 23 cl / 7 12/16 oz

BACU20D7 20 cl / 6 12/16 oz

BACU18D7 18 cl / 6 1/16 oz



Saucer

Soucoupe
Untertasse
Platillo

**BASA15D7 > BACU23D7, BACU20D7,
BACU18D7**

15 cm / 5 14/16"



Cup stackable

Tasse empilable
Tasse stapelbar
Taza apilable

BACU09D7 9 cl / 3 1/16 oz



Saucer

Soucoupe
Untertasse
Platillo

BASA13D7 > BACU09D7

13 cm / 5 2/16"



Coffee pot & lid

Cafetière & couvercle
Kaffeekanne & Deckel
Cafetera & tapa

BACP70D7 70 cl / 23 11/16 oz

BACP35D7 35 cl / 11 13/16 oz



Lid for coffee pot

Couvercle pour cafetière
Deckel für Kaffeekanne
Tapa para cafetera

BACPLD2D7 > BACP70D7

BACPLD1D7 > BACP35D7



Teapot & lid

Théière & couvercle
Teekanne & Deckel
Tetera & tapa

BATP80D7 80 cl / 27 1/16 oz

BATP40D7 40 cl / 13 8/16 oz



Lid for teapot

Couvercle pour théière
Deckel für Teekanne
Tapa para tetera

BATPLD2D7 > BATP80D7

BATPLD1D7 > BATP40D7



Creamer

Crémier
Milchkännchen
Lechera

BACR35D7 35 cl / 11 13/16 oz

BACR25D7 25 cl / 8 7/16 oz



BACR15D7 15 cl / 5 1/16 oz



Sugar bowl & lid

Sucrier & couvercle
Zuckerdose & Deckel
Azucarero & tapa

BASU27D7 27 cl / 9 2/16 oz



Lid for sugar bowl

Couvercle pour sucrier
Deckel für Zuckerdose
Tapa para azucarero

BASULDD7



Salt shaker

Salière
Salzstreuer
Salero

BASS01D7



Pepper shaker

Poivrier
Pfefferstreuer
Pimentero

BAPS01D7



 Pieces per box
Pièces par boîte
Stück pro Karton
Piezas por caja

 Stored in Europe
Entreposé en Europe
In Europa gelagert
Almacendo en Europa





LEON

En The relief decoration of Leon gives it an originality and strength of character that provide incomparable brilliance to your performances. The product line combines geometric shapes with Aztec accents and modernity.

De Das Reliefdekor der Kollektion Leon vermittelt gleichermaßen Kraft und Charakter und verleiht Ihren Kreationen einen unvergleichlichen Glanz. In dieser Kollektion verschmelzen geometrische Formen und aztekische sowie moderne Akzente zu einem harmonischen Gesamtbild.

Fr Le décor en relief de Leon lui confère une originalité et une force de caractère qui apportent un éclat incomparable à vos prestations. La gamme marie formes géométriques aux accents aztèques et modernité.

Es El decorado en relieve de Leon le otorga una originalidad y una fuerte personalidad que aportan un brillo incomparable a los servicios de restauración. La gama conjuga las formas geométricas de acentos aztecas y la modernidad.



LEON COLLECTION



Flat plate

Assiette plate
Teller flach
Plato llano

BAFP31D1 31 cm - 12 3/16"
 6

BAFP30D1 30 cm - 11 13/16"
 6

BAFP29D1 29 cm - 11 7/16"

BAFP27D1 27 cm - 10 10/16"
 12

BAFP25D1 25 cm - 9 13/16"
 12

BAFP24D1 24 cm - 9 7/16"
 12

BAFP23D1 23 cm - 9 1/16"
 12

BAFP21D1 21 cm - 8 4/16"
 24

BAFP20D1 20 cm - 7 14/16"
 24

BAFP19D1 19 cm - 7 8/16"

BAFP17D1 17 cm - 6 11/16"

BAFP15D1 15 cm - 5 14/16"
 24



Deep plate

Assiette creuse
Teller tief
Plato hondo

BADP30D1 30 cm - 11 13/16"
 6

BADP26D1 26 cm - 10 4/16"

BADP23D1 23 cm - 9 1/16"
 12



Steak plate oval

Assiette à steak ovale
Steakteller oval
Plato steak oval

BAOP30D1 30 x 25,5 cm
11 13/16 x 10 1/16"
 6



Oval platter

Plat ovale
Platte oval
Fuente oval

BAOP38D1 38 cm
14 15/16"

BAOP32D1 32 cm - 12 10/16"
 6

BAOP22D1 22 cm - 8 11/16"
 12



Bowl

Bol
Schale
Bol

BABW14D1 14 cm - 63 cl
5 8/16" - 21 5/16 oz
 12



Cream soup bowl 2 handles

Tasse bouillon 2 anses
Suppentasse 2 Henkel
Bol consommé 2 asas

BACS30D1 30 cl - 10 2/16 oz
 6



Saucer

Soucoupe
Untertasse
Platillo

BAST01D1 > **BACS30D1**
17 cm - 6 11/16"
 12



Salad bowl

Saladier
Salatschale
Ensaladera

BASP25D1 25 cm - 200 cl
9 13/16" - 67 10/16 oz
 1

BASP20D1 20 cm - 105 cl
7 14/16" - 35 8/16 oz

BASP16D1 16 cm - 67 cl
6 5/16" - 22 10/16 oz
 12



Salad bowl stackable

Saladier empilable
Salatschale stapelbar
Ensaladera apilable

BASB21D1 21 cm - 118 cl
8 4/16" - 39 14/16 oz

BASB16D1 16 cm - 60 cl
6 5/16" - 20 5/16 oz
 12

**Cup stackable**

Tasse empilable

Tasse stapelbar

Taza apilable

BACU23D1 23 cl - 7 12/16 oz**BACU20D1** 20 cl - 6 12/16 oz**BACU18D1** 18 cl - 6 1/16 oz**Saucer**

Soucoupe

Untertasse

Platillo

BASA15D1 > **BACU23D1**, **BACU20D1**
BACU18D1

15 cm - 5 14/16"

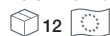
**Cup stackable**

Tasse empilable

Tasse stapelbar

Taza apilable

BACU09D1 9 cl - 3 1/16 oz**Saucer**

Soucoupe

Untertasse

Platillo

BASA13D1 > **BACU09D1**

13 cm - 5 2/16"

**Creamer**

Crémier

Milchkännchen

Lechera

BACR25D1 25 cl - 8 7/16 oz**Sugar pack holder**

Sucrier sachets

Zuckertütenschale

Azucarero sobres

BASH01D1 9 x 3 x 2 cm

3 9/16 x 1 3/16 x 13/16"

**Sugar bowl & lid**

Sucrier & couvercle

Zuckerdose & Deckel

Azucarero & tapa

BASU27D1 27 cl - 9 2/16 oz**Lid for sugar bowl**

Couvercle pour sucrier

Deckel für Zuckerdose

Tapa para azucarero

BASULDD1**Egg cup**

Coquetier

Eierbecher

Huevera

BAEG01D1**Pepper shaker**

Poivrier

Pfefferstreuer

Pimentero

BAPS01D1**Salt shaker**

Salière

Salzstreuer

Salero

BASS01D1

 Pieces per box
Pièces par boîte
Stück pro Karton
Piezas por caja

 Stored in Europe
Entreposé en Europe
In Europa gelagert
Almacendo en Europa



Flat plate

Assiette plate
Teller flach
Plato llano

MEFP31 31 cm / 12 3/16"



MEFP29 29 cm / 11 7/16"

MEFP27 27 cm / 10 10/16"

MEFP24 24 cm / 9 7/16"



MEFP21 21 cm / 8 4/16"

MEFP17 17 cm / 6 11/16"

MEFP15 15 cm / 5 14/16"



Deep plate

Assiette creuse
Teller tief
Plato hondo

MEDP30 30 cm / 11 13/16"



MEDP26 26 cm / 10 4/16"

MEDP23 23 cm / 9 1/16"



Coffee cup

Tasse à café
Kaffeetasse
Taza a café

MECU20 20 cl / 6 12/16 oz



Saucer for coffee cup

Soucoupe pour tasse à café
Untere für Kaffeetasse
Platillo para taza a café

MESA15 15 cm / 5 14/16"



Espresso cup

Tasse à espresso
Espressotasse
Taza a expreso

MECU09 9 cl / 3 1/16 oz



Saucer for espresso cup

Soucoupe pour tasse à espresso
Untere für Espressotasse
Platillo para taza a expreso

MESA13 13 cm / 5 2/16"



Creamer

Crémier
Milchkännchen
Lechera

MECR15 15 cl / 5 1/16 oz





METROPOLIS

En Metropolis creates a cosmopolitan, chic and urban atmosphere, ideally suited for a tasting in total tranquillity. Giving it a retro look, the classic striations of this collection give it a relief that is pleasant to the touch while diffusing a savoury light.

Fr Métropolis crée une atmosphère cosmopolite, chic et citadine, idéale pour une dégustation en toute quiétude. Avec une touche rétro, les striures classiques de cette collection donnent un relief agréable au toucher et diffuse une lumière savoureuse.

De Die Kollektion Metropolis verbreitet eine kosmopolitische, elegante und städtische Atmosphäre, wie sie für den stillen Genuss nicht besser passen könnte. Durch die klassische Riefelung mit dem leichten Retro-Touch liegt die Kollektion gut in der Hand, außerdem sorgt die Riefelung für angenehme Lichtreflexionen.

Es Metropolis crea una atmósfera cosmopolita, elegante y urbana, ideal para una degustación serena. Con un toque retro, las estrías clásicas de esta colección le confieren un relieve agradable al tacto y difunden una luz deliciosa.





STONELEAF

En Developed exclusively by RAK Porcelain, Stoneleaf uses a new non-porous ceramic material that is lighter than natural materials. To be used either alone or with plates, Stoneleaf improves handling and stability with silicone pads fixed under the items.

De Bei der exklusiv von RAK Porzellan entwickelten Kollektion Stoneleaf kommt ein neues keramisches Material zum Einsatz, das nicht porös ist und deutlich weniger wiegt als natürliche Materialien. Stoneleaf-Produkte können alleine oder auf Tellern eingesetzt werden. Für zusätzliche Stabilität sorgen Silikonfüße auf der Unterseite.

Fr Développée en exclusivité par RAK Porcelain, Stoneleaf utilise un nouveau matériau céramique non poreux et plus léger que les matières naturelles. A utiliser seul ou combiné à des assiettes, Stoneleaf facilite les manipulations et la stabilité grâce à des patins de silicone fixés sous les articles.

Es Desarrollada en exclusiva por RAK Porcelain, Stoneleaf utiliza un nuevo material cerámico no poroso y más ligero que los naturales. Las planchas Stoneleaf pueden utilizarse solas o combinadas con platos y facilitan la manipulación y la estabilidad gracias a unos tacos de silicona fijados bajo las piezas.



STONELEAF COLLECTION



Rectangular tray compatible with BURT52 (Buffet)

Plat rectangulaire compatible avec BURT52 (Buffet)

Platte rechteckig kompatibel mit BURT52 (Buffet)

Bandeja rectangular compatible con BURT52 (Buffet)

SLTR48 48,5 x 19,5 cm
19 2/16 x 7 11/16"



Rectangular tray compatible with SPDP30 (Allspice)

Plat rectangulaire compatible avec SPDP30 (Allspice)

Platte rechteckig kompatibel mit SPDP30 (Allspice)

Bandeja rectangular compatible con SPDP30 (Allspice)

SLTR24 24,5 x 14,5 cm
9 10/16 x 5 11/16"



Rectangular tray compatible with CLRP38 (Classic Gourmet)

Plat rectangulaire compatible avec CLRP38 (Classic Gourmet)

Platte rechteckig kompatibel mit CLRP38 (Classic Gourmet)

Bandeja rectangular compatible con CLRP38 (Classic Gourmet)

SLTR33 33 x 15,5 cm
13 x 6 12/16"



Square tray

Plat carré

Platte quadratisch

Bandeja cuadrada

SLSP30 30 x 30 cm
11 13/16 x 11 13/16"



Rectangular tray compatible with CLRP39 (Classic Gourmet)

Plat rectangulaire compatible avec CLRP39 (Classic Gourmet)

Platte rechteckig kompatibel mit CLRP39 (Classic Gourmet)

Bandeja rectangular compatible con CLRP39 (Classic Gourmet)

SLTR25 25 x 7,5 cm
9 13/16 x 2 15/16"



Square tray compatible with CLSP30 (Classic Gourmet)

Plat carré compatible avec CLSP30 (Classic Gourmet)

Platte quadratisch kompatibel mit CLSP30 (Classic Gourmet)

Bandeja cuadrada compatible con CLSP30 (Classic Gourmet)

SLSP25 24,5 x 24,5 cm
9 10/16 x 9 10/16"





Trapezoidal tray compatible with LXBS51 (B. Concept)

Plat trapezoïdal compatible avec LXBS51 (B. Concept)

Platte trapezförmig kompatibel mit LXBS51 (B. Concept)

Bandeja trapezoidal compatible con LXBS51 (B. Concept)

SLBC46 46 x 25 cm
18 2/16 x 9 13/16"



Trapezoidal tray compatible with LXBS30 (B. Concept)

Plat trapezoïdal compatible avec LXBS30 (B. Concept)

Platte trapezförmig kompatibel mit LXBS30 (B. Concept)

Bandeja trapezoidal compatible con LXBS30 (B. Concept)

SLBC22 22 x 19,5 cm
8 11/16 x 7 11/16"



Round dish compatible with SPCH30 (Allspice)

Plat rond compatible avec SPCH30 (Allspice)

Teller rund kompatibel mit SPCH30 (Allspice)

Plato redondo compatible con SPCH30 (B. Concept)

SLRD12 12 cm / 4 12/16"

SLRD9 9 cm / 3 9/16"

SLRD7 7 cm / 2 12/16"



 Pieces per box
Pièces par boîte
Stück pro Karton
Piezas por caja

 Stored in Europe
Entreposé en Europe
In Europa gelagert
Almacendo en Europa





MINIMAX

En Eclectic and full of good ideas, Minimax offers a range of complementary items to be used alone or combined with other collections. With a variety of small and large sizes, Minimax provides innovative solutions to your most unusual culinary requests.

Fr Éclectique et pleine de bonnes idées, Minimax propose une gamme d'articles complémentaires à utiliser seuls ou en harmonie avec d'autres collections. Avec un assortiment de petites et grandes tailles, Minimax procure des solutions originales à vos requêtes culinaires les plus insolites.

De Mit offenem Design und voller spannender Ideen präsentiert sich die Kollektion Minimax gleichermaßen als eigenständige Serie und als harmonische Ergänzung anderer Kollektionen. Durch die große Auswahl an kleinen und großen Formen erfüllt Minimax auch außergewöhnliche gastronomische Anforderungen.

Es Ecléctica y repleta de buenas ideas, Minimax ofrece una gama de artículos complementarios que pueden utilizarse solos o combinados en perfecta armonía con otras colecciones. Con una combinación de tamaños grandes y pequeños, Minimax presenta soluciones originales a sus más insólitas exigencias culinarias.



MINIMAX COLLECTION

PLATTERS AND PLATES PLATS ET ASSIETTES PLATTEN UND TELLER FUENTES Y PLATOS



Island platter

Plat île
Inselplatte
Bandeja isla

NAIP39 39 x 31 x 3 cm
15 6/16 x 12 3/16 x 1 3/16"

NAIP33 33 x 27,5 x 3 cm
13 x 10 13/16 x 1 3/16"



Leaf bowl

Bol feuille
Blattschale
Bol hoja

NABW28 28,5 x 17 cm - 63 cl
11 4/16 x 6 8/16" - 24 13/16 oz

NABW22 22 x 14,5 cm - 45 cl
8 11/16 x 5 11/16" - 17 11/16 oz

NABW16 16,5 x 12 cm - 20 cl
6 8/16 x 4 12/16" - 7 14/16 oz



Leaf plate

Plat feuille
Blattplatte
Plato hoja

NAOP48 48,5 x 30 cm
19 2/16 x 11 13/16"



NAOP38 38 x 25,5 cm
14 15/16 x 10 1/16"



Oval plate

Plat oval
Platte oval
Plato oval

MNOP33 33 x 13,5 cm
13 x 5 5/16"



Main half moon platter

Plat demi-lune
Halbmondplatte
Plato media luna

MNMP38 38,5 x 15,5 cm
15 3/16 x 6 2/16"



Service tray 16 indents

Plat service 16 empreintes
Serviceplatte 16 Vertiefungen
Bandeja 16 estanques

LXST39 > SPCU09 39 x 28 cm
15 6/16 x 11"



Cup without handle

Tasse sans anse
Tasse ohne Henkel
Taza sin asa

SPCU09 9 cl / 3 1/16 oz



Platter drop shape

Plat forme de goutte
Platte Tropfenform
Plato forma gota

ACDS01 35,5 x 18,5 cm
14 x 7 5/16"



Rectangular long dish

Plat long rectangulaire
Platte lang rechteckig
Plato largo rectangular

OPRL40 40 x 10,5 cm
15 12/16 x 4 2/16"



Rectangular dish

Ravier rectangulaire
Schale rechteckig
Rabanera rectangular

OPCD26 26 x 16 x 4 cm - 100 cl
10 4/16 x 6 5/16 x 1 9/16" -
33 13/16 oz

OPCD20 20 x 16 x 3,5 cm - 59 cl
7 14/16 x 6 5/16 x 1 6/16" -
xx xx/16 oz



OPCD17 17 x 13 x 4 cm - 50 cl
6 11/16 x 5 2/16 x 1 9/16" -
16 15/16 oz





**Rectangular plate
6 compartments**
Assiette rectangulaire
6 compartiments
Platte rechteckig mit 6 Flächen
Plato rectangular 6
compartimentos

OPRP6C 28 x 20 x 2 cm
11 x 7 14/16 x 13/16"



Square plate 4 compartments
Assiette carrée 4 compartiments
Platte quadratisch mit 4 Flächen
Plato cuadrado 4
compartimentos

OPSP4C 20 x 20 cm
7 14/16 x 7 14/16"



**Rectangular tray
3 compartments**
Plat rectangulaire
3 compartiments
Platte rechteckig mit 3 Flächen
Bandeja rectangular
3 compartimentos

OPRT19C 19 x 17 cm
7 8/16 x 6 11/16"



Rectangular tray
Plat rectangulaire
Platte rechteckig
Bandeja rectangular

OPRT18 18 x 7,5 cm
7 1/16 x 2 15/16"



Bowl
Bol
Schale
Bol

NAMB37 37 cm - 120 cl
14 9/16 - 40 9/16 oz



NAMB31 31 cm - 95 cl
12 3/16" - 32 2/16 oz



NAMB27 27 cm - 70 cl
10 10/16" - 23 11/16 oz

NAMB16 16 cm - 12 cl
6 5/16" - 4 1/16 oz



Sandwich tray
Plat à sandwich
Sandwichplatte
Bandeja sándwich

OPST39 39 x 28 cm
15 6/16 x 11"



Sandwich tray
Plat à sandwich
Sandwichplatte
Bandeja sándwich

OPSP45 45 x 15 cm
17 11/16 x 5 14/16"



OPSP35 35 x 15 cm
13 12/16 x 5 14/16"



OPSP24 24 x 14,1 cm
9 7/16 x 5 9/16 x 1/16"



OPSP14 14 x 8 cm
5 8/16 x 3 2/16"



Sandwich tray, 2 indents
Plat à sandwich, 2 empreintes
Sandwichplatte, 2 Vertiefungen
Bandeja sándwich, 2 estanques

OPSP35IN 35 x 15 cm
13 12/16 x 5 14/16"





MINIMAX COLLECTION



Small rectangular tray
Plat rectangulaire petit
Platte rechteckig klein
Bandeja rectangular pequeña

OPTR12 12 x 7,5 cm
4 12/16 x 2 15/16"



Snack plate
Plat à snack
Snackplatte
Plato snack

OPRP18 18 x 11,5 cm
7 1/16 x 4 8/16"



Square plate
Assiette carrée
Teller quadratisch
Plato cuadrado

OPSP08 8 cm / 3 2/16"



OPSP06 6 cm / 2 6/16"



Half moon plate
Assiette demi lune
Teller Halbmond
Plato media luna

OPMP01 21 x 12 x 2
8 4/16" x 4 12/16 x 13/16"



Oval plate rimless
Plat ovale sans bord
Platte oval ohne Rand
Fuente oval sin borde

OPOP19 19 x 15,5 cm
7 8/16 x 6 2/16"



DEEP PLATTERS PLATS CREUX PLATTEN TIEF FUENTES HONDO

Square bowl

Bol carré
Schale quadratisch
Bol cuadrado

OPSB15 15 cm / 5 14/16"



OPSB12 12 cm / 4 12/16"



OPSB09 9 cm / 3 9/16"



OPSB08 8 cm / 3 2/16"



OPSB07 7 cm / 2 12/16"



Triangular bowl

Bol triangulaire
Schale dreieckig
Bol triangular

OPTB12 12 cm / 4 12/16"

OPTB10 9,5 cm / 3 12/16"



Deep bowl boat

Bol profond bateau
Bootschale tief
Bol hondo barco

MNDB116 22,7 x 13 - 116 cl
8 15/16 x 5 2/16" - 45 11/16 oz



Lid for deep bowl boat

Couvercle pour bol profond bateau
Deckel für Bootschale tief
Tapa para bol hondo barco

MNDBLD10 23 x 13,5 cm
9 1/16 x 5 5/16"



Deep bowl boat

Bol profond bateau
Bootschale tief
Bol hondo barco

MNDB50 19,5 x 11,7 - 60 cl
7 11/16 x 4 10/16" - 23 10/16 oz



**Bowl boat**

Bol bateau
Bootschale
Bol barco

MNSB68 22,5 x 13,5 - 68 cl
8 14/16 x 5 5/16" - 26 12/16 oz

**Boat dish**

Plat bateau
Bootschale
Plato barco

MNSB44 23 x 13 - 44 cl
9 1/16 x 5 2/16" - 14 14/16 oz

**Lid for boat dish**

Couvercle pour plat bateau
Deckel für Bootschale
Tapa para plato barco

MNSBLD01 23 x 13 cm
9 1/16 x 5 2/16"

**Boat dish**

Plat bateau
Bootschale
Plato barco

MNSB34 20,8 x 11,5 - 34,5 cl
8 3/16 x 4 8/16" - 13 9/16 oz

**Bowl boat**

Bol bateau
Bootschale
Bol barco

MNSB32 17 x 10,5 - 32 cl
6 11/16 x 4 2/16" - 12 10/16 oz

**Mini boat bowl**

Mini bol bateau
Mini Schale Boot
Mini bol barco

MNOD09 14,8 x 8,5 - 11 cl
5 13/16 x 3 6/16" - 4 5/16 oz

**Eared oval dish**

Plat à gratin oval
Platte oval
Plato oval

OPOD30 30 x 16 x 5,2 cm - 78 cl
11 13/16 x 6 5/16 x 2 1/16" -
26 oz



OPOD25 25 x 14 x 4,3 cm - 42 cl
9 13/16 x 5 8/16 x 1 11/16" -
14 3/16 oz



OPOD24 24 x 13 x 4 cm - 32,5 cl
9 7/16 x 5 2/16 x 1 9/16" - 11 oz

OPOD20 20 x 11 x 3,5 cm - 20 cl
7 14/16 x 4 5/16 x 1 6/16" -
6 12/16 oz

**Rectangular dish with grip**

Plat rectangulaire à poignées
Teller rechteckig mit Griffen
Plato rectangular con puñado

OPRT16 16 cm / 6 5/16"

**Oval pie dish stackable**

Plat ovale empilable
Platte oval stapelbar
Plato oval apilable

OPOS20 20 x 12 cm - 42 cl
7 14/16 x 4 12/16" - 14 3/16 oz

**Pie dish**

Plat à gratin
Platte für gratin
Plato a gratin

OPPD15 15 x 11 - 28 cl
5 14/16 x 4 5/16 - 9 7/16 oz

**Rectangular bowl stackable**

Plat rectangulaire empilable
Schale rechteckig stapelbar
Fuente rectangular apilable

OPRB17 17 x 8 cm - 15 cl
6 11/16 x 3 2/16 - 5 1/16 oz





MINIMAX COLLECTION



Eared round dish

Coupelle ronde
Schälchen rund
Plato redondo

OPRD16 16 cm - 45 cl
6 5/16 - 15 3/16"



ARTICLES WITH LID ARTICLES AVEC COUVERCLE ARTIKEL MIT DECKEL ARTÍCULOS CON TAPA



Rectangular tureen & lid

Terrine rectangulaire & couvercle
Terrine rechteckig & Deckel
Rectangular tarrina & tapa

OPTU23 23 x 18 x 13,7 cm - 160 cl
9 1/16 x 7 1/16 x 5 6/16" -
54 2/16 oz

OPTU20 19,5 x 15,4 x 11,6 cm - 104 cl
7 11/16 x 6 1/16 x 4 9/16" -
35 3/16 oz



OPTU16 16,4 x 13,5 x 10 cm - 60 cl
6 7/16 x 5 5/16 x 3 15/16" -
20 5/16 oz

OPTU15 15 x 11,8 x 9 cm - 39 cl
5 14/16 x 4 10/16 x 3 9/16" -
13 3/16 oz

OPTU13 13 x 10,2 x 7,7 - 30 cl
5 2/16 x 4 x 3 1/16" - 10 2/16 oz

OPTU12 11,7 x 9,2 x 7 cm - 20 cl
4 10/16 x 3 10/16 x 2 12/16" -
6 12/16 oz



Lid for tureen

Couvercle pour terrine
Deckel für Terrine
Tapa para tarrina

OPTULD23 > OPTU23

OPTULD20 > OPTU20

OPTULD16 > OPTU16

OPTULD15 > OPTU15

OPTULD13 > OPTU13

OPTULD12 > OPTU12



Handi bowl & lid

Bol Handi & couvercle
Handi Schale & Deckel
Bol Handi & tapa

OPHB150 17 x 18,5 x 13 cm - 150 cl
6 11/16 x 7 5/16 x 5 2/16" -
50 12/16 oz



OPHB89 19 x 19,5 x 10 cm - 90 cl
7 8/16 x 7 11/16 x 3 15/16" -
30 7/16 oz



OPHB85 14,8 x 16,5 x 11 cm - 85 cl
5 13/16 x 6 8/16 x 4 5/16" -
28 12/16 oz



OPHB50 14,5 x 15,5 x 9 cm - 50 cl
5 11/16 x 6 2/16 x 3 9/16" -
16 15/16 oz



Lid for handi bowl

Couvercle pour bol Handi
Deckel für Handi Schale
Tapa para bol Handi

OPHBLD150 > OPHB150

OPTBLD89 > OPHB89

OPHBLD85 > OPHB85

OPHBLD50 > OPHB50



Bowl & lid

Bol & couvercle
Schale & Deckel
Bol & tapa

OPBW15 15 x 15 cm / 5 14/16 x 5 14/16"



Lid for bowl

Couvercle pour bol
Deckel für Schale
Tapa para bol

OPBULD15



Jungle CS bowl & lid

Bol jungle CS & couvercle
Dschungelschale CS & Deckel
Bol jungle CS & tapa

NAJB57 57 cl / 19 4/16 oz



Lid for jungle CS bowl

Couvercle pour bol jungle CS
Deckel für Dschungelschale CS
Tapa para bol jungle CS

NALD01



CUPS AND BOWLS
TASSES ET BOLES
TASSEN UND SCHALEN
TAZAS Y BOLS

**Noodle bowl**

Bol à nouilles
Nudelschale
Bol a tallarines

OPNB15 15 cm - 63 cl
5 14/16" - 21 5/16 oz

**Round bowl Katori**

Bol rond Katori
Schale rund Katori
Bol redondo Katori

MNRD10 10 x 4,4 cm - 18 cl
3 15/16 x 1 12/16" - 6 1/16 oz

**Casino mug stackable**

Casino chope empilable
Casino Becher stapelbar
Mug casino apilable

OPCM23 23 cl
7 12/16 oz

**Baltic mug stackable**

Baltic chope empilable
Baltic Becher stapelbar
Mug Baltic apilable

OPBMG23 23 cl
7 12/16 oz

**Cup**

Tasse
Tasse
Taza

OPCU15 15 cl
5 1/16 oz

**Ambrosia mug**

Chope Ambrosia
Ambrosia Becher
Mug Ambrosia

ACAM35 35 cl
11 13/16oz

ACAM25 25 cl
8 7/16 oz

**Sunshine mug**

Sunshine chope
Sunshine Becher
Mug Sunshine

OPSMG33 33 cl / 11 3/16 oz

OPSMG24 24 cl / 8 2/16 oz

OPSMG18 18 cl / 6 1/16 oz

OPSMG09 9 cl / 3 1/16 oz



ACCESSORIES
ACCESSOIRES
ZUBEHÖR
ACCESORIOS

**Square fruit bowl**

Coupelle carrée
Schälchen quadratisch
Bol frutero cuadrado

OPFB10 10 x 10 x 4 cm - 18 cl
3 15/16 x 3 15/16 x 1 9/16" -
6 12/16 oz

**Sauce cup & lid**

Moutardier & couvercle
Senftopf & Deckel
Salsera & tapa

OPCU12 7 x 6,5 cm - 12 cl
2 12/16 x 2 9/16 - 4 1/16 oz





MINIMAX COLLECTION

Lid for sauce cup

Couvercle pour moutardier
Deckel für Senftopf
Tapa para Salsera

OPLD01 7 cm / 2 12/16"



Spoon for sauce cup

Cuillère pour moutardier
Löffel für Senftopf
Cuchara para salsera

OPSP12 12 cm / 4 12/16"



Sauce bottle & lid

Saucière & couvercle
Saucenkännchen & Deckel
Salsera & tapa

ACSY01 9 cm - 11 cl
3 9/16" - 3 12/16 oz



Lid for sauce bottle

Couvercle pour saucière
Deckel für Saucenkännchen
Tapa salsera

ACSYLD01



Magic oil/vinegar

Huillier/vinaigrier
Öl/Essigkanne
Aceitera/vinagrero

ACOV01 20 cl / 6 12/16 oz



Lid for vinegar pot

Couvercle pour vinaigrier
Deckel für Essigkanne
Tapa aceitera/vinagrero

ACOVLD



Yin yang saucer

Yin yang saucière
Yin yang Sauciere
Salsera ying yang

ACYY01 10 cm / 3 15/16"



Golf ball pepper shaker

Poivrier balle de golf
Pfefferstreuer Golfball
Pimentero pelota de golf

OPGB01 4 x 4 cm
1 9/16 x 1 9/16"



Golf ball salt shaker

Salière balle de golf
Salzstreuer Golfball
Salero pelota de golf

OPGB02 4 x 4 cm
1 9/16 x 1 9/16"



Pepper shaker

Poivrier
Pfefferstreuer
Pimentero

OPPS01 5,5 x 2,4 x 4 cm
2 3/16 x 15/16 x 1 9/16"



Salt shaker

Salière
Salzstreuer
Salero

OPSS01 5,5 x 2,4 x 4 cm
2 3/16 x 15/16 x 1 9/16"



Soup spoon

Cuillère à soupe
Suppenlöffel
Cuchara de sopa

ACSP01 12 cm / 4 12/16"



Stand for spoon

Reposoir à cuillère
Stand für Löffel
Reposa cuchara

ACSS01 11,5 x 5,5 cm
4 8/16 x 2 3/16"



**Chopstick stand**

Porte baguettes
Stäbchenhalter
Reposa palillos

ACCS01 6 cm / 2 6/16"

24

MINIATURES
MINIATURES
MINIATUREN
MINIATURAS

**Cube high**

Cube haut
Kubus hoch
Cubo alto

OPSD01 5 x 5 x 5,5 cm
1 15/16 x 1 15/16 x 2 3/16"

12

**Cube small**

Cube bas
Kubus klein
Cubo bajo

OPSD02 5 x 5 x 4,5 cm
1 15/16 x 1 15/16 x 1 12/16"

12

**Mini pan with grip**

Mini poêlon avec poignée
Mini Pfanne mit Griff
Mini sartén con asa

MNMP01 10 x 6,2 cm
3 15/16 x 2 7/16"

12

**Square sauce dish**

Bol à sauce carré
Saucenschale quadratisch
Bol salsa cuadrado

ACSD01 7,5 x 3,2 cm
2 15/16 x 1 4/16"

6

**Twin sauce bowl rectangular**

Coupelle à sauce double
Doppelte Saucenschale rechteckig
Bol salsa doble rectangular

ACTS01 14,5 x 7 cm
5 11/16 x 2 12/16"

6

**Condiment boat dish**

Coupelle à condiments bateau
Schälchen für Gewürze Boot
Bol condimentos barco

MNOD05 7,4 x 4,5 cm - 3 cl
2 14/16 x 1 12/16" - 1 oz

12

**Miniature boat triangle**

Miniature bateau triangle
Miniatur Boot dreieckig
Miniatura barco triángulo

MNTD01 7,5 x 6 x 3 cm
2 15/16 x 2 6/16 x 1 3/16"

6

**Miniature boat square**

Miniature bateau carré
Miniatur Boot quadratisch
Miniatura barco cuadrado

MNSD01 6 x 6 x 3 cm
2 6/16 x 2 6/16 x 1 3/16"

6

**Angular dish**

Plat angulaire
Platte winklig
Bol oblicuo

OPAB06 6 x 6 x 2 cm
2 6/16 x 2 6/16 x 13/16"

12



MINIMAX COLLECTION



Miniature bowl round

Miniature bol rond
Miniaturschale rund
Miniatura bol redondo

OPCU05 5 cl / 1 11/16 oz



Egg cup

Coquetier
Eierbecher
Huevera

OPEG01 5,2 x 4,9 cm
2 1/16 x 1 15/16"



Square bowl

Bol carré
Schale quadratisch
Bol cuadrado

OPSB04 4 x 4 cm
1 9/16 x 1 9/16"



Ramekin with grooves

Ramequin plissé
Auflaufform gerillt
Cuenco estriado

ACRG10 10 cm - 33 cl
3 15/16" - 11 3/16 oz

ACRG09 9 cm - 19 cl
3 9/16" - 6 7/16"



Rectangular dish

Ravier rectangulaire
Schale rechteckig
Platillo rectangular

ACRD10 10 cm / 3 15/16"



 Pieces per box
Pièces par boîte
Stück pro Karton
Piezas por caja

 Stored in Europe
Entreposé en Europe
In Europa gelagert
Almacendo en Europa







NANO

En With a traditional Asian charm, Nano's lines are exquisitely pure. This collection's plain style allows it to be adapted to different dishes and uses, immersing the gourmet into a peace of mind that incites tasting.

De Mit ihrer klaren Linienführung vermittelt die Kollektion Nano traditionellen asiatischen Charme. Durch die nüchterne Gestaltung kann die Kollektion für zahlreiche Gerichte und Einsatzbereiche verwendet werden, und der Gourmet kann sich voll und ganz dem kulinarischen Genuss hingeben.

Fr Avec un charme traditionnel venu d'Asie, Nano présente des lignes d'une exquise pureté. Son style dépouillé permet à cette collection de s'adapter à des plats et des usages variés pour plonger le gourmand dans une tranquillité d'esprit propice à la dégustation.

Es Con un encanto tradicional venido de Asia, las líneas de Nano son de una pureza exquisita. Su estilo sobrio le permite adaptarse a todo tipo de platos y usos para sumir al gourmet en una serenidad espiritual que propicia la degustación.



NANO COLLECTION



Coupe flat plate

Assiette plate coupe
Teller flach coupe
Plato llano coupe

NNPR31 31 cm / 12 3/16"
 6

NNPR27 27 cm / 10 10/16"

NNPR24 24 cm / 9 7/16"

NNPR21 21 cm / 8 4/16"

12

NNPR18 18 cm / 7 1/16"

NNPR15 15 cm / 5 14/16"

24



Coupe bowl

Bol coupe
Schale coupe
Bol coupe

BUBC30 30 cm - 190 cl
11 13/16" - 64 4/16 oz

6

BUBC26 26 cm - 120 cl
10 4/16" - 40 9/16 oz

12



Oval platter

Plat ovale
Platte oval
Fuente oval

NNOP36 36 x 27 cm / 14 3/16 x 10 10/16"

NNOP32 32 x 23 cm / 12 10/16 x 9 1/16"

6

NNOP26 26 x 19 cm / 10 4/16 x 7 8/16"

NNOP21 21 x 15 cm / 8 4/16 x 5 14/16"

12



Cereal bowl

Bol à céréales
Muesli-Schale
Tazón de cereales

NNBW20 20 cm - 90 cl
7 14/16" - 30 7/16 oz

6



Bowl non stackable

Bol non empilable
Schale nicht stapelbar
Bol no apilable

NNBW12 12 cm - 27 cl / 4 12/16" - 9 2/16 oz

NNBW10 10 cm - 16 cl / 3 15/16" - 5 7/16 oz

NNBW09 9 cm - 11 cl / 3 9/16" - 3 12/16 oz

12



Rice bowl

Bol à riz
Reisschale
Bol arroz

NNRB16 16 cm - 58 cl / 6 5/16" - 19 10/16 oz
 12



Cream soup bowl & lid

Bol bouillon & couvercle
Suppentasse & Deckel
Bol consommé & tapa

NNCS27 12 cm - 27 cl / 4 12/16" - 9 2/16 oz
 6

Lid for cream soup bowl

Couvercle pour bol à bouillon
Deckel für Suppentasse
Tapa para bol consommé

NNCS27LD
 12



Saucer for soup bowl

Soucoupe pour bol bouillon
Untere für Suppentasse
Platillo para bol consommé

NNST16 16 cm / 6 5/16"
 12



Bowl & lid

Bol & couvercle
Schale & Deckel
Bol & tapa

NNCU17 9 cm - 17 cl / 3 9/16" - 5 12/16 oz
 12



Saucer for bowl

Soucoupe pour bol
Untertasse für Schale
Platillo para bol

NNSA10 10 cm / 3 15/16"
 12



Teapot & lid

Théière & couvercle
Teekanne & Deckel
Tetera & tapa

NNTP110 110 cl / 37 3/16 oz
 4



NNTP40 40 cl / 13 8/16 oz
 4

Lid for teapot

Couvercle pour théière
Deckel für Teekanne
Tapa para tetera

NNTPLD2 > NNTP110

NNTPLD1 > NNTP40

 12

**Creamer**

Crémier
Milchkännchen
Lechera

NNCR15 15 cl / 5 1/16 oz

 6

**Sugar bowl & lid**

Sucrier & couvercle
Zuckerdose & Deckel
Azucarero & tapa

NNSU25 25 cl / 8 7/16 oz

 6

Lid for sugar bowl

Couvercle pour sucrier
Deckel für Zuckerdose
Tapa para azucarero

NNSULD

 12

**Butter dish**

Assiette à beurre
Butterschale
Plato mantequilla

NNBD09 9 cm / 3 9/16"

NNBD07 7 cm / 2 12/16"

 12 

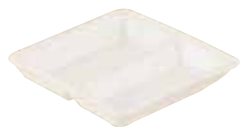
**Cubicle double dish**

Plat à sauce 2 compartiments
Doppelsaucenschale
Plato a salsa rectangular 2
compartimientos

NNCD02 8,7 cm / 3 7/16"

 12

**Oil/vinegar/sauce soja pot**

Huillier/vinaigrier/pot à sauce soja
Kanne für Öl/Essig/Sojasosse
Aceitera/vinagrera/jarra a salsa soja

NNOV12 12 cl / 4 1/16 oz

 12

Lid for vinegar pot

Couvercle pour vinaigrier
Deckel für Essigkanne
Tapa para vinagrero

NNOVL

 12

**Oil/vinegar/soja pot stand**

Support à huile/vinaigre/sauce soja
Platte für Öl/Essig/Sojasosse
Platillo para aceitera/vinagrera/
salsa soja

NNST19 19 cm / 7 8/16"

 12

**Spoon**

Cuillère
Löffel
Cuchara

NNSP14 14 cm / 5 8/16"

 12 

**Spoon/chopstick stand**

Cuillère/repose baguette
Löffel/Stäbchenhalter
Cuchara/soporte palillos

NNST07 7 cm / 2 12/16"

 12

**Wine cup**

Coupe à vin
Weinbecher
Copa de vino

NNWC01 1,2 cl / 6/16 oz

 6





PIXEL

En Because taste is a tactile experience, Pixel displays a relief decoration inviting to the touch. With a delicate note of originality, its imprints reflect the light for a sensory dining experience.

De Genießen ist und bleibt eine Tätigkeit für alle Sinne, auch den Tastsinn. Die Kollektion Pixel lädt mit ihrem Relief-Dekor förmlich dazu ein, ertastet zu werden. Dezent und originell zugleich wirkt sich das Relief auf die Lichtwahrnehmung und die geschmackliche Sensorik aus.

Fr Parce que goûter reste une expérience tactile, Pixel affiche un décor en relief qui invite au toucher. Avec une délicate note d'originalité, ses empreintes réfléchissent la lumière pour une expérience gustative sensorielle.

Es Degustar es siempre una experiencia táctil, y por eso Pixel ostenta una decoración en relieve que invita a tocar. Con un delicado toque de originalidad, sus huellas reflejan la luz para facilitar una experiencia gustativa sensorial.



PIXEL COLLECTION



Flat plate

Assiette plate
Teller flach
Plato llano

PXFP32 32 cm / 12 10/16"
 6

PXFP29 29 cm / 11 7/16"
PXFP27 27 cm / 10 10/16"
PXFP24 24 cm / 9 7/16"
PXFP21 21 cm / 8 4/16"

12

PXFP17 17 cm / 6 11/16"

24



Deep plate

Assiette creuse
Teller tief
Plato hondo

PXDP28 28 cm / 11"
PXDP24 24 cm / 9 7/16"

12



Oval plate

Plat ovale
Platte oval
Fuente oval

PXOP36 36 cm / 14 3/16"
PXOP34 34 cm / 13 6/16"

6



Cereals bowl

Bol à céréales
Muesli Schale
Bol a cereales

PXBC30 30 cl / 10 2/16 oz
 12



Cream bowl 2 handles

Tasse bouillon 2 anses
Suppentasse 2 Henkel
Bol consomé 2 asas

PXCS35 35 cl / 11 13/16 oz
 12



Cup

Tasse
Tasse
Taza

PXCU35 35 cl / 11 13/16 oz
PXCU30 30 cl / 10 2/16 oz
PXCU27 27 cl / 9 2/16 oz

12



Saucer

Soucoupe
Untertasse
Platillo

PXSA17 > PXCU35, PXCU30, PXCU27
17 cm / 6 11/16"

12



Cup

Tasse
Tasse
Taza

PXCU22 22 cl / 7 7/16 oz

12



Saucer

Soucoupe
Untertasse
Platillo

PXSA15 > PXCU22

15 cm / 5 14/16"

12



Cup

Tasse
Tasse
Taza

PXCU09 9 cl / 3 1/16 oz

12



Saucer

Soucoupe
Untertasse
Platillo

PXSA12 > PXCU09

12 cm / 4 12/16"

12

**Teapot & lid**

Théière & couvercle
Teekanne & Deckel
Tetera & tapa

PXTP40 40 cl / 13 8/16 oz

**Lid for teapot**

Couvercle pour théière
Deckel für Teekanne
Tapa para tetera

PXTPLD

**Coffee pot & lid**

Cafetière & couvercle
Kaffeekanne & Deckel
Cafetera & tapa

PXCP35 35 cl / 11 13/16 oz

**Lid for coffee pot**

Couvercle pour cafetière
Deckel für Kaffeekanne
Tapa para cafetera



PXCPLD

**Creamer**

Crémier
Milchkännchen
Lechera

PXCR15 15 cl / 5 1/16 oz

**Sugar bowl & lid**

Sucrier & couvercle
Zuckerdose & Deckel
Azucarero & tapa

PXSU25 25 cl - 8 7/16

**Lid for sugar bowl**

Couvercle pour sucrier
Deckel für Zuckerdose
Tapa para azucarero

PXSULD

**Salt shaker**

Salière
Salzstreuer
Salero

PXSS01

**Pepper shaker**

Poivrier
Pfefferstreuer
Pimentero

PXPS01

**Candle holder**

Chandelier
Kerzenhalter
Porta velas

PXCH01

**Tooth pick holder**

Conteneur cure dents
Zahnstocherhalter
Palillero

PXTH01

**Egg Cup**

Coquetier
Eierbecher
Huevera

PXEG01

**Ashtray**

Cendrier
Ascher
Cenicero

PXAT01







BUFFET

En An integral part of any major culinary event, the Buffet collection combines design and unfailing solidity. The different variations made possible by its functional dishes morph any tasting into a unique experience.

De Die Kollektion Buffet darf bei großen gastronomischen Ereignissen nicht fehlen. In ihr verschmelzen attraktives Design und höchste, dauerhafte Robustheit. Die verschiedenen praktischen Platten ermöglichen eine Kombinationsvielfalt, mit der jedes Essen zu einem einzigartigen Erlebnis wird.

Fr Partie intégrante des grands rendez-vous culinaires, la collection Buffet réunit design et solidité à toutes épreuves. Les variations offertes par ses différents plats fonctionnels transforment toute dégustation en expérience unique.

Es Parte integrante de las grandes citas culinarias, la colección Buffet conjuga diseño y solidez a toda prueba. Las variaciones que ofrecen sus distintas fuentes funcionales hacen de la degustación una experiencia única.



BUFFET COLLECTION



Angular bowl

Bol asymétrique
Schale asymmetrisch
Bol asimétrico

BUBA29 29 cm - 14 cm - 160 cl
11 7/16" x 5 8/16" - 54 2/16 oz



BUBA22 22 cm - 9 cm - 65 cl
8 11/16" - 3 9/16" - 22 oz



Coupe bowl

Bol coupe
Schale coupe
Plato coupe

BUBC46 46 cm - 4 cm - 575 cl
18 2/16" - 1 9/16" - 194 7/16 oz

BUBC36 36 cm - 4 cm - 360 cl
14 3/16" - 1 9/16" - 121 12/16 oz



Square bowl

Bol carré
Schale quadratisch
Bol cuadrado

BUBS25 25 x 25 cm - 416 cl
9 13/16 x 9 13/16" - 140 11/16 oz



Soup tureen & lid

Soupière & couvercle
Suppenterrine & Deckel
Sopera & tapa

BUCD15 15 cm - 58 cl
5 14/16" - 19 10/16 oz



Lid for soup bowl tureen

Couvercle pour soupière
Deckel für Suppenterrine
Tapa para sobpera

BUCDLD



Oval dish

Plat ovale
Platte Oval
Fuente Oval

BUOD37 37 x 25,5 x 5 cm
14 9/16 x 10 1/16 x 1 15/16"



BUOD30 30 x 20 x 5 cm
11 13/16 x 7 14/16 x 1 15/16"



BUOD28 28 x 19 x 5 cm
11 x 7 8/16 x 1 15/16"

BUOD25 25 x 18 x 5 cm

9 13/16 x 7 1/16 x 1 15/16"



Oval dish

Plat ovale
Platte Oval
Fuente oval

BUOP56 56 x 21 cm - 220 cl
22 1/16 x 8 4/16" - 74 6/16 oz



Oval dish

Plat ovale
Platte Oval
Fuente oval

BUOV40 40 x 23 x 4 cm - 154 cl
15 15/16 x 9 1/16 x 1 9/16"
52 1/16 oz

BUOV36 36 x 22 x 5 cm - 136 cl
14 3/16 x 8 7/16 x 1 15/16"
46 oz



BUOV29 29 x 14 x 5,7 cm - 100 cl
11 10/16 x 5 8/16 x 2 4/16"
33 13/16 oz

BUOV24 24 x 14,3 x 4,2 cm - 54 cl
9 7/16 x 5 10/16 x 1 10/16"
18 4/16 oz





Rectangular pan

Plat rectangulaire
Platte rechteckig
Fuente rectangular

BURP44 44 x 36 x 6 cm - 500 cl
17 5/16 x 14 3/16 x 2 6/16"
169 1/16 oz

BURP37 37 x 30 x 6 cm - 347 cl
14 9/16 x 11 10/16 x 2 6/16"
117 5/16 oz



BURP30 30 x 23,8 x 6,4 cm - 212 cl
11 13/16 x 9 6/16 x 2 8/16"
71 11/16 oz



Rectangular tray

Plat rectangulaire
Platte rechteckig
Fuente rectangular

BURT52 52 x 24 cm / 20 8/16 x 9 7/16"



BURT41 41 x 30 cm / 16 2/16 x 11 13/16"



Salad bowl xxl

Saladier xxl
Salatschale xxl
Ensaladera xxl

BUSB31 31 x 17 cm - 600 cl
12 3/16 x 6 11/16" - 202 14/16 oz



Square dish

Ravier carré
Schale quadratisch
Rabanera cuadrada

BUSD28 28 x 28 x 6 cm - 243 cl
11 x 11 x 2 6/16" - 82 3/16 oz



BUSD22 22,5 x 22,5 x 4,5 cm - 100 cl
8 14/16 x 8 14/16 x 1 12/16"
33 13/16 oz



Stackable rectangular long dish

Plat rectangulaire long empilable
Schale rechteckig lang stapelbar
Plato rectangular largo apilable

LXRB47 47 x 20 x 6 cm
18 8/16 x 7 14/16 x 2 6/16"



Stackable twin divider dish

Plat rectangulaire empilable
Stapelbare Doppelschüssel &
Trennwand

Plato apilable 2 divisiones

LXDB18 18 x 20 x 6 cm
7 1/16 x 7 14/16 x 2 6/16"



Stack dish & divider

Plat trapézoïdal empilable
Schüssel & Trennwand
Stapelbare

Bandeja divisora apilable

LXBW18 18 x 20 x 6 cm
7 1/16" x 7 14/16 x 2 6/16"



Stackable rectangular half bowl

Plat rectangulaire empilable
Halbe Schüssel rechteckig
stapelbar

Medio bol rectangular apilable

LXRB27 27 x 20 x 6 cm
10 10/16 x 7 14/16 x 2 6/16"







BUFFET GN

En A perfect complement to the Buffet collection, all of Buffet GN's shapes and sizes meet the GASTRONORM standard required for use in dish warmers, display cases, refrigerated display shelves and baking ovens. These dishes are designed for ease of handling and to withstand heat stress or shocks resulting from intensive use thanks to an unfailing solidity.

Fr Complémentaire de la collection Buffet, Buffet GN possède toutes les formes et tailles à la norme GASTRONORM nécessaires pour des utilisations en chauffe-plat, vitrines, présentoirs réfrigérés et fours de cuisson. Ces plats sont conçus pour faciliter les manipulations et résister aux agressions thermiques ou aux chocs inhérents à une utilisation intensive grâce à une solidité à toute épreuve.

De Die Serie Buffet GN ergänzt die Kollektion Buffet um sämtliche Formen und Größen der GASTRONORM-Norm für den Einsatz in Warmhalteplatten, (Kühl-) Vitrinen und Öfen. Die Formen dienen der leichteren Handhabung und sind äußerst resistent gegenüber thermischer Beanspruchung, Stoßeinwirkung und intensiver Nutzung.

Es Complementaria de la colección Buffet, Buffet GN dispone de todas las formas y tamaños de la norma GASTRONORM, necesarios para usos como calentaplatos, vitrinas, expositores refrigerados y hornos de cocción. Estas fuentes están concebidas para facilitar las manipulaciones y soportar las agresiones térmicas o los choques inherentes a un uso intensivo gracias a su solidez a toda prueba.



BUFFET GN COLLECTION

1/1



Gastronorm pan
Plat Gastronorm
Schale Gastronorm
Fuente Gastronorm

BUGN1.1 53 x 32,5 x 6,5 cm - 730 cl
20 14/16 x 12 13/16 x 2 9/16" -
246 13/16 oz



Gastronorm pan
Plat Gastronorm
Schale Gastronorm
Fuente Gastronorm

BUGN1.1F 53 x 32,5 x 2 cm - 220 cl
20 14/16 x 12 13/16 x 13/16" -
74 6/16 oz



1/2



Gastronorm pan
Plat Gastronorm
Schale Gastronorm
Fuente Gastronorm

BUGN1.2 32,5 x 26,5 x 6,5 cm - 330 cl
12 13/16 x 10 7/16 x 2 9/16" -
111 9/16 oz



Gastronorm pan
Plat Gastronorm
Schale Gastronorm
Fuente Gastronorm

BUGN1.2F 32,5 x 26,5 x 2 cm - 130 cl
12 13/16 x 10 7/16 x 13/16" -
43 15/16 oz



1/3



Gastronorm pan
Plat Gastronorm
Schale Gastronorm
Fuente Gastronorm

BUGN1.3 32,5 x 17,6 x 6,5 cm - 200 cl
12 13/16 x 6 15/16 x 2 9/16" -
67 10/16 oz



Gastronorm pan
Plat Gastronorm
Schale Gastronorm
Fuente Gastronorm

BUGN1.3F 32,5 x 17,6 x 2 cm - 79 cl
12 13/16 x 6 15/16 x 13/16" -
26 11/16 oz



2/3



Gastronorm pan
Plat Gastronorm
Schale Gastronorm
Fuente Gastronorm

BUGN2.3 32,5 x 35,4 x 6,5 cm - 478 cl
12 13/16 x 13 15/16 x 2 9/16" -
161 10/16 oz



Gastronorm pan
Plat Gastronorm
Schale Gastronorm
Fuente Gastronorm

BUGN2.3F 32,5 x 35,4 x 2 cm
12 13/16 x 13 15/16 x 13/16"



2/4



Gastronorm pan

Plat Gastronorm
Schale Gastronorm
Fuente Gastronorm

BUGN2.4 53 x 16,2 x 6,5 cm - 260 cl
20 14/16 x 6 6/16 x 2 9/16" -
87 15/16 oz



Gastronorm pan

Plat Gastronorm
Schale Gastronorm
Fuente Gastronorm

BUGN2.4F 53 x 16,2 x 2 cm - 125 cl
20 14/16 x 6 6/16 x 13/16" -
42 4/16 oz



Half-moon pan gastronorm

Plat Gastronorm demi-lune
Schale Gastronorm Halbmond
Fuente Gastronorm media-luna

BUGN20 39 x 19,5 x 6,5 cm - 191 cl
15 6/16 x 7 11/16 x 2 9/16" -
64 9/16 oz



Half-moon pan gastronorm

Plat Gastronorm demi-lune
Schale Gastronorm Halbmond
Fuente Gastronorm media-luna

BUGN20F 39 x 19,5 x 2 cm - 95 cl
15 6/16 x 7 11/16 x 13/16" -
32 2/16 oz



Gastronorm pan round

Plat Gastronorm rond
Schale Gastronorm rund
Fuente Gastronorm redondo

BUGN39 39 x 6,2 cm - 433 cl
15 6/16 x 2 7/16" - 146 7/16 oz



Gastronorm pan round divided

Plat Gastronorm rond divisé
Schale Gastronorm rund geteilt
Fuente Gastronorm redondo
dividido

BUGN39D 39 x 6,2 cm - 400 cl
15 6/16 x 2 7/16" - 135 4/16 oz



Pieces per box
Pièces par boîte
Stück pro Karton
Piezas por caja

Stored in Europe
Entreposé en Europe
In Europa gelagert
Almacendo en Europa





B.CONCEPT

En Designed by RAK Porcelain to provide an innovative solution, B-Concept can harmoniously present the most diverse of buffets. Flexible and innovative, the different items of B-Concept can be used all day long and are compatible with items from other collections, especially Minimax and Buffet.

Fr Conçu par RAK Porcelain pour apporter une solution innovante, B-Concept permet de présenter les buffets les plus variés de façon toujours harmonieuse. Flexible et originale, les différentes pièces de B-Concept s'utilisent du matin au soir, également compatibles avec des pièces de diverses collections, notamment celles de Minimax et Buffet.

De Die innovative Kollektion B-Concept wurde von RAK Porzellan speziell für harmonische Buffets der besonderen Art entworfen. Die flexiblen und einzigartigen Komponenten von B-Concept lassen sich bei Frühstückstafeln ebenso einsetzen wie bei Abenddiners. Auch in Kombination mit anderen Kollektionen, insbesondere Minimax und Buffet, kann B-Concept hervorragend eingesetzt werden.

Es Concebida por RAK Porcelain para ofrecer una solución innovadora, B-Concept siempre permite presentar los buffets más variados de una forma armoniosa. Flexibles y originales, las distintas piezas de B-Concept se utilizan de la mañana a la noche y también son compatibles con piezas de distintas colecciones, como las de Minimax y Buffet.



B. CONCEPT COLLECTION



Platter

Plat
Platte
Fuente

LXBS51 51 x 30 cm
20 1/16 x 11 13/16"

LXBS30 30 x 12 cm
11 13/16 x 4 12/16"



Platter black

Plat noir
Platte schwarz
Fuente negro

LXBS51BK 51 x 30 cm
20 1/16 x 11 13/16"

LXBS30BK 30 x 12 cm
11 13/16 x 4 12/16"



Wood stand big

Support bois grand modèle
Holzständer gross
Soporte de madera grande

WS51 51 x 30 cm
20 1/16 x 11 13/16"



Wood stand small

Support bois petit modèle
Holzständer klein
Soporte de madera pequeño

WS30 30 x 26 cm
11 13/16 x 10 4/16"



En Support of varnished wood withstanding abrasion and mechanical shocks, available with 3 sets bases to screw on, 3 heights: 5 cm, 10 cm and 14 cm / 1 1/16", 3 15/16" and 5 14/16"

De Träger aus lackiertem Holz, das Verschleißerscheinungen und mechanischen Stößen standhält, lieferbar mit 3 Fußsätzen zum Anschrauben, 3 Maße: 5 cm, 10 cm und 14 cm / 1 1/16", 3 15/16" und 5 14/16"

Fr Support en bois vernis résistant à l'abrasion et aux chocs mécaniques, livré avec 3 jeux de pieds à visser, 3 hauteurs: 5 cm, 10 cm et 14 cm / 1 1/16", 3 15/16" et 5 14/16"

Es Soporte de madera barnizada, resistente a la abrasión y a los choques mecánicos, se entrega con 3 juegos de papas enroscables, de 3 alturas: 5 cm, 10 cm y 14 cm / 1 1/16", 3 15/16" y 5 14/16"

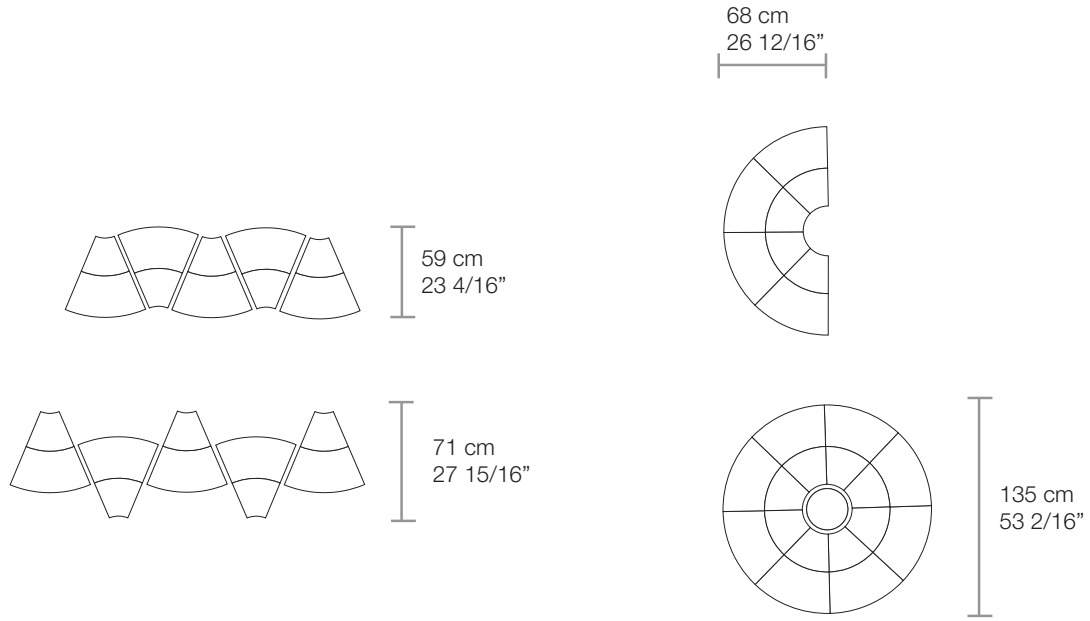



Design by Vavro





TWEEG

En Discrete and charming, the Tweeg product line exudes nature, greenery and simplicity. It expresses exquisite freshness, a lightness of being which lets you drift off into another world.

De Die diskrete und charmante Kollektion Tweeg verströmt einen Hauch von Natürlichkeit und Einfachheit. Sie wirkt zugleich frisch und leicht und lädt dazu ein, den Alltag und Stress einen Moment hinter sich zu lassen.

Fr Discrète et charmante, la gamme Tweeg respire la nature, la verdure et la simplicité. Elle exprime avec une fraîcheur exquise, une légèreté d'être qui invite à l'évasion.

Es Discreta y con encanto, la gama Tweeg respira naturaleza, verdor y sencillez. Expresa con exquisita frescura una ligereza que invita a la evasión.



TWEEG COLLECTION



Rectangular flat plate

Assiette plate rectangulaire
Teller flach rechteckig
Plato llano rectangular

CLRP33D96 33 x 24 cm / 13" x 9 7/16"

6



Square flat plate

Assiette plate carrée
Teller flach quadratisch
Plato llano cuadrado

CLSP30D96 30 cm / 11 13/16"

6



Round flat plate

Assiette plate ronde
Teller flach rund
Plato llano redondo

CLFP31D96 31 cm / 12 3/16"

6

CLFP27D96 27 cm / 10 10/16"

12

CLFP21D96 21 cm / 8 4/16"

24



Round deep plate

Assiette creuse ronde
Teller flach tief
Plato hondo redondo

CLDP26D96 26 cm / 10 4/16"

12



Non stackable cup (Classic Gourmet)

Tasse non empilable (Classic Gourmet)

Tasse nicht stapelbar (Classic Gourmet)

Taza no apilable (Classic Gourmet)

CLCU23 23 cl / 7 12/16 oz

CLCU20 20 cl / 6 12/16 oz

12



Saucer

Soucoupe

Untertasse

Platillo

CLSA15D96 > CLCU23 / CLCU20

15 cm / 5 14/16"

12



Non stackable cup (Classic Gourmet)

Tasse non empilable (Classic Gourmet)

Tasse nicht stapelbar (Classic Gourmet)

Taza no apilable (Classic Gourmet)

CLCU09 9 cl / 3 1/16 oz

12



Saucer

Soucoupe

Untertasse

Platillo

CLSA13D96 > CLCU09

12,5 cm / 4 15/16"

12

Pieces per box
Pièces par boîte
Stück pro Karton
Piezas por caja





Rectangular flat plate
Assiette plate rectangulaire
Teller flach rechteckig
Plato llano rectangular
CLRP33D97 33 x 24 cm / 13" x 9 7/16"
6



Square flat plate
Assiette plate carrée
Teller flach quadratisch
Plato llano cuadrado
CLSP30D97 30 cm / 11 13/16"
6



Round flat plate
Assiette plate ronde
Teller flach rund
Plato llano redondo
CLFP31D97 31 cm / 12 3/16"
6
CLFP27D97 27 cm / 10 10/16"
12
CLFP21D97 21 cm / 8 4/16"
24



Round deep plate
Assiette creuse ronde
Teller tief rund
Plato hondo redondo
CLDP26D97 26 cm / 10 4/16"
12



Non stackable cup (Classic Gourmet)
Tasse non empilable (Classic Gourmet)
Tasse nicht stapelbar (Classic Gourmet)
Taza no apilable (Classic Gourmet)
CLCU23 23 cl / 7 12/16 oz
CLCU20 20 cl / 6 12/16 oz
12



Saucer for cup
Soucoupe
Untertasse
Platillo
CLSA15D97 > **CLCU23** / **CLCU20**
15 cm / 5 14/16"
12



Non stackable cup (Classic Gourmet)
Tasse non empilable (Classic Gourmet)
Tasse nicht stapelbar (Classic Gourmet)
Taza no apilable (Classic Gourmet)
CLCU09 9 cl / 3 1/16 oz
12



Saucer for cup
Soucoupe
Untertasse
Platillo
CLSA13D97 > **CLCU09**
12,5 cm / 4 15/16"
12



1973

En This design reminds us of a time when demands for freedom were born with the emergence of nonconformity resulting in a brightly coloured design. This product line takes us on a journey back in time to the Seventies.

De Das Design ist ein Blick zurück auf die Zeit, in der der Wunsch nach mehr Freiheit unsere Gesellschaft bestimmte. Der Nonkonformismus der Zeit drückte sich auch in einem Stil voller lebhafter Farben aus. Mit dieser Kollektion gehen wir auf Zeitreise zurück in die 1970^{er} Jahre.

Fr Ce design nous rappelle toute une époque où des revendications de liberté virent le jour, avec l'émergence d'un anticonformisme traduit par un stylisme aux couleurs vives. Cette gamme nous emmène dans un voyage à remonter le temps pour se retrouver dans les années « seventies ».

Es Este diseño recuerda la época en que surgieron las reivindicaciones de libertad, con la aparición de un anticonformismo que se tradujo en un estilismo de colores vivos. Esta gama nos transporta en un viaje por el tiempo para llevarnos a los setenta.

**Flat plate**

Assiette plate
Teller flach
Plato llano

BAFP31D98 31 cm / 12 3/16"



BAFP27D98 27 cm / 10 10/16"



BAFP21D98 21 cm / 8 4/16"

**Deep plate**

Assiette creuse
Teller tief
Plato hondo

BADP23D98 23 cm / 9 1/16"

**Tea/coffee cup**

Tasse à thé/café
Tee- Kaffeetasse
Taza a té/café

BACU23D98 23 cl / 7 12/16 oz

**Saucer for tea/coffee cup**

Soucoupe pour tasse à thé/café
Untere für Tee- Kaffeetasse
Platillo para taza a té/café

BASA15D98 15 cm / 5 14/16"

**Espresso cup**

Tasse à espresso
Espressotasse
Taza a expreso

BACU09D98 9 cl / 3 1/16 oz

**Saucer for espresso cup**

Soucoupe pour tasse à espresso
Untere für Espressotasse
Platillo para taza a expreso

BASA13D98 13 cm / 5 2/16"





YASMEEN

En With its mineral shade the Yasmeen collection reflects serenity. This appeasing and contemporary design blends beautifully with the Banquet collection to create a peaceful and relaxed atmosphere.

De Mit ihrem mineralischen Farbton verbreitet die Kollektion Yasmeen Ausgeglichenheit. Das beruhigende und gleichermaßen zeitgenössische Design passt perfekt zur Kollektion Banquet und vermittelt Ruhe und Entspannung.

Fr Avec une tonalité de couleur minérale, la collection Yasmeen invite à la sérénité. Ce design apaisant et contemporain se marie merveilleusement avec la collection Banquet pour créer une atmosphère calme et détendue.

Es Con una tonalidad de color mineral, la colección Yasmeen invita a la serenidad. Este diseño contemporáneo que transmite serenidad se asocia maravillosamente con la colección Banquet para crear una atmósfera tranquila y distendida.





BAHAMAS 1

En The Bahamas collection's soft and warm terracotta colours invite you to a journey. The diversity of shades lets you, for instance, separate different diets at a glance or play the "mix-and-match" card to your heart's content.

Fr Riche en couleurs terracotta douces et chaleureuses, la collection Bahamas invite au voyage. La variété de tons permet par exemple de séparer les différents régimes alimentaires au premier coup d'œil ou de jouer le « mix and match » sans limites.

De Mit ihren reichen Farben in weichen und warmen Terrakotta-Tönen weckt die Kollektion Bahamas das Fernweh. Mit den verschiedenen Farbtönen können beispielsweise Speisen auf den ersten Blick erkennbar voneinander getrennt werden, oder das Geschirr wird bunt durcheinander kombiniert.

Es Rica en colores terracota suaves y cálidos, la colección Bahamas invita al viaje. La variedad de tonos permite, por ejemplo, separar los distintos regímenes alimentarios de un vistazo o jugar al «mix and match» sin limitación alguna.



BAHAMAS 1 COLLECTION



Flat plate

Assiette plate
Teller flach
Plato llano

30 cm / 11 13/16"



27 cm / 10 10/16"



24 cm / 9 7/16"



21 cm / 8 4/16"



15 cm / 5 14/16"

- BAFP30D88
- BAFP30D89
- BAFP30D90

- BAFP27D88
- BAFP27D89
- BAFP27D90

- BAFP24D88
- BAFP24D89
- BAFP24D90

- BAFP21D88
- BAFP21D89
- BAFP21D90

- BAFP15D88
- BAFP15D89
- BAFP15D90



Deep plate

Assiette creuse
Teller tief
Plato hondo

26 cm / 10 4/16"

23 cm / 9 1/16"



- BADP26D88
- BADP26D89
- BADP26D90

- BADP23D88
- BADP23D89
- BADP23D90



Salad bowl stackable

Saladier empilable
Salatschale stapelbar
Ensaladera apilable

16 cm - 60 cl
6 5/16" - 20 5/16 oz

12 cm - 25 cl
4 12/16" - 8 7/16 oz



- BASB16D88
- BASB16D89
- BASB16D90

- BASB12D88
- BASB12D89
- BASB12D90



Tea/coffee cup

Tasse à thé/café
Tee- Kaffeetasse
Taza a té/café

23 cl / 7 12/16 oz



- BACU23D88
- BACU23D89
- BACU23D90

Saucer for tea/coffee cup

Soucoupe pour Tasse à thé/café
Untere für Tee- Kaffeetasse
Platillo para taza a té/café

15 cm / 5 14/16"



- BASA15D88
- BASA15D89
- BASA15D90

**Espresso cup**

Tasse à expresso

Espressotasse

Taza a expreso

9 cl / 3 1/16 oz

■ BACU09D88

■ BACU09D89

■ BACU09D90

**Saucer for espresso cup**

Soucoupe pour tasse à expresso

Untere für Espressotasse

Platillo para taza a expreso

13 cm / 5 2/16"

■ BASA13D88

■ BASA13D89

■ BASA13D90

**Mug**

Chope

Becher

Mug

30 cl / 10 2/16 oz

■ BASM30D88

■ BASM30D89

■ BASM30D90



Pieces per box
 Pièces par boîte
 Stück pro Karton
 Piezas por caja

Stored in Europe
 Entreposé en Europe
 In Europa gelagert
 Almacendo en Europa



Lemon yellow
D53

Sky blue
D54

Spring green
D57

Chilly red
D56



BAHAMAS 2

En Azure blue, fire red, lemon yellow, lime green, these bright colours of Bahamas 2 provide a dazzling palette, which creates refreshing harmonies.

De Azurblau, feuerrot, zitronengelb, grasgrün – mit den lebhaften Farben der Kollektion Bahamas 2 schaffen Sie erfrischend neue harmonische Kombinationen.

Fr Bleu azur, rouge feu, jaune citron, vert acidulé, les couleurs vives de Bahamas 2 fournissent une palette éclatante de pièces permettant de créer des harmonies rafraîchissantes.

Es Azul celeste, rojo fuego, amarillo limón, verde ácido, los vivos colores de Bahamas 2 forman parte de una paleta brillante de piezas que permiten crear armonías refrescantes.



BAHAMAS 2 COLLECTION



Flat plate
Assiette plate
Teller flach
Plato llano

30 cm / 11 13/16"

- BAFP30D53
- BAFP30D54
- BAFP30D56
- BAFP30D57



27 cm / 10 10/16"



- BAFP27D53
- BAFP27D54
- BAFP27D56
- BAFP27D57

24 cm / 9 7/16"

- BAFP24D53
- BAFP24D54
- BAFP24D56
- BAFP24D57



21 cm / 8 4/16"



- BAFP21D53
- BAFP21D54
- BAFP21D56
- BAFP21D57

15 cm / 5 14/16"

- BAFP15D53
- BAFP15D54
- BAFP15D56
- BAFP15D57



Deep plate
Assiette creuse
Teller tief
Plato hondo

26 cm / 10 4/16"

- BADP26D53
- BADP26D54
- BADP26D56
- BADP26D57

23 cm / 9 1/16"



- BADP23D53
- BADP23D54
- BADP23D56
- BADP23D57





Tea/coffee cup

Tasse à thé/café

Tee- Kaffeetasse

Taza a té/café

23 cl / 7 12/16 oz

■ BACU23D53

■ BACU23D54

■ BACU23D56

■ BACU23D57

12



Saucer for tea/coffee cup

Soucoupe pour tasse à thé/café

Untere für Tee- Kaffeetasse

Platillo para taza a té/café

15 cm / 5 14/16"

■ BASA15D53

■ BASA15D54

■ BASA15D56

■ BASA15D57

12



Espresso cup

Tasse à expresso

Espressotasse

Taza a expreso

9 cl / 3 1/16 oz

■ BACU09D53

■ BACU09D54

■ BACU09D56

■ BACU09D57

12



Saucer for espresso cup

Soucoupe pour tasse à expresso

Untere für Espressotasse

Platillo para taza a expreso

13 cm / 5 2/16"

■ BASA13D53

■ BASA13D54

■ BASA13D56

■ BASA13D57

12



 Pieces per box
 Pièces par boîte
 Stück pro Karton
 Piezas por caja



Flat plate

Assiette plate
Teller flach
Plato llano

BAFP31D99 31 cm / 12 3/16"



BAFP27D99 27 cm / 10 10/16"



BAFP21D99 21 cm / 8 4/16"



Deep plate

Assiette creuse
Teller tief
Plato hondo

BADP23D99 23 cm / 9 1/16"



Tea/coffee cup

Tasse à thé/café
Tee- Kaffeetasse
Taza a té/café

BACU23D99 23 cl / 7 12/16 oz



Saucer for tea/coffee cup

Soucoupe pour tasse à thé/café
Untere für Tee- Kaffeetasse
Platillo para taza a té/café

BASA15D99 15 cm / 5 14/16"



Espresso cup

Tasse à espresso
Espressotasse
Taza a expreso

BACU09D99 9 cl / 3 1/16 oz



Saucer for espresso cup

Soucoupe pour tasse à espresso
Untere für Espressotasse
Platillo para taza a expreso

BASA13D99 13 cm / 5 2/16"





CASTELLO

En In shades of pastel colours, the Castello collection brings out an atmosphere of hushed elegance, designed to create moments of mellowness. Castello beautifully links classicism and cocoon-like atmosphere.

De Die in Pastellfarben gehaltene Kollektion Castello vermittelt eine gedämpfte Eleganz, die wie geschaffen ist für sanfte Momente. Die Kollektion ist eine wunderbare Verschmelzung von klassischem Stil und Behaglichkeit.

Fr Dans des tons de couleurs pastel, la collection Castello dégage une ambiance d'élégance feutrée, conçue pour créer des moments de douceur. Castello lie merveilleusement classicisme et ambiance ouatée.

Es En tonos pastel, la colección Castello desprende un ambiente de suave elegancia. Ha sido concebida para crear dulces momentos. Castello conjuga maravillosamente el classicismo y el ambiente acogedor.





UNIVERSAL SAUCER

CLSA01

Classic gourmet

15,7 cm / 6 3/16"

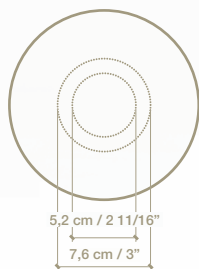

SPRP18IN

All spice

17,7 x 14 cm

6 15/16 x 5 8/16"

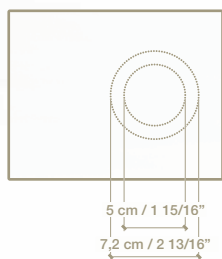

SPRP24IN

All spice

24 x 14 cm

9 7/16 x 5 8/16"

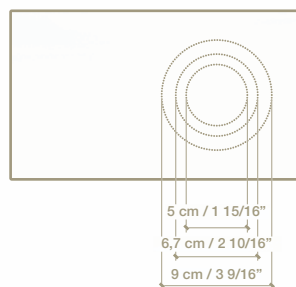

SPRP28IN

All spice

28,5 x 14 cm

11 4/16 x 5 8/16"

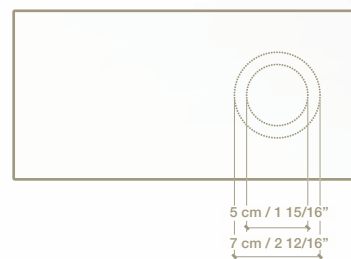

CLSA01

Classic gourmet

15,7 cm / 6 3/16"
ø 5,2 - 7,6 cm / 2 1/16 - 3"**SPRP18IN**

All spice

17,7 x 14 cm / 6 15/16 x 5 8/16"
ø 5 - 7,2 cm / 1 15/16 - 2 13/16"**SPRP24IN**

All spice

24 x 14 cm / 9 7/16 x 5 8/16"
ø 5 - 6,7 - 9 cm / 1 15/16 -
2 10/16 - 3 9/16"**SPRP28IN**

All spice

28,5 x 14 cm / 1 14/16 x 5 8/16"
ø 5 - 7 cm / 1 15/16 x 2 12/16"FDCU30
Fine dineLRSC27
LyraLRCU27
LyraFDCU25
Fine dineBACU23
BanquetSKCU23
SkaBANC22
BanquetGDCU21
White goldFDCU20
Fine dine

CLSA01
 Classic gourmet
 15,7 cm / 6 3/16"
 ø 5,2 - 7,6 cm / 2 1/16 - 3"



SPRP18IN
 All spice
 17,7 x 14 cm / 6 15/16 x 5 8/16"
 ø 5 - 7,2 cm / 1 15/16 - 2 13/16"



SPRP24IN
 All spice
 24 x 14 cm / 9 7/16 x 5 8/16"
 ø 5 - 6,7 - 9 cm / 1 15/16 - 2 10/16 - 3 9/16"



SPRP28IN
 All spice
 28,5 x 14 cm / 1 14/16 x 5 8/16"
 ø 5 - 7 cm / 1 15/16 x 2 12/16"



NOCU20
 Nordic



BACU20
 Banquet



BACU18
 Banquet



GDCU09
 White gold



FDCU09
 Fine dine



NOMG33
 Nordic



FDMU30
 Fine dine



SKSM30
 Ska



OPSMG24
 Minimax



CLSA01

Classic gourmet

15,7 cm / 6 3/16"
ø 5,2 - 7,6 cm / 2 1/16 - 3"**SPRP18IN**

All spice

17,7 x 14 cm / 6 15/16 x 5 8/16"
ø 5 - 7,2 cm / 1 15/16 - 2 13/16"**SPRP24IN**

All spice

24 x 14 cm / 9 7/16 x 5 8/16"
ø 5 - 6,7 - 9 cm / 1 15/16 -
2 10/16 - 3 9/16"**SPRP28IN**

All spice

28,5 x 14 cm / 1 14/16 x 5 8/16"
ø 5 - 7 cm / 1 15/16 x 2 12/16"FDCP35
Fine dineFDTP40
Fine dineBACS01
BanquetFDCU30M1
Fine dineGDCU21M
White goldNNSU25
NanoCLCR25
Classic gourmetSPCB11
All spiceNNBW10
Nano

CLSA01

Classic gourmet

15,7 cm / 6 3/16"
 ø 5,2 - 7,6 cm / 2 1/16 - 3"



SPRP18IN

All spice

17,7 x 14 cm / 6 15/16 x 5 8/16"
 ø 5 - 7,2 cm / 1 15/16 - 2 13/16"



SPRP24IN

All spice

24 x 14 cm / 9 7/16 x 5 8/16"
 ø 5 - 6,7 - 9 cm / 1 15/16 - 2 10/16 - 3 9/16"



SPRP28IN

All spice

28,5 x 14 cm / 1 14/16 x 5 8/16"
 ø 5 - 7 cm / 1 15/16 x 2 12/16"



GDCU09M
 White gold



SPCU09
 All spice



CLCS30
 Classic gourmet



NNCS27
 Nano



BACS30
 Banquet



BACS18
 Banquet



BACS02
 Banquet



BAGB35
 Banquet



NOMB1
 Nordic





En
The plate warmer:

- Depending on the outside temperature, the heating time may vary from 25 – 40 minutes to reach a comfortable temperature of 40 to 50°C for the items
- Up to 29 plates with a 29 cm maximum diameter can be kept at temperature using very little electricity.
- Integrated long-term temperature control through its sensor technology.
- Quiet operation & elegant design
- German quality product, TÜV and GSZ certified
- Enhances the quality of the service
- Guaranteed customer satisfaction
- Cover fabric is flame retardant and easy to clean

Fr
Le chauffe-assiettes :

- Le temps de réchauffage est - selon la température extérieure - de 25 – 40 minutes pour atteindre une température des articles agréable, de 40 à 50°C
- Jusqu'à 29 assiettes de 29 cm de diamètre maximum peuvent être gardées à température et ceci à faible consommation d'énergie électrique
- Contrôle de température à longue durée intégrée grâce à sa technologie des capteurs
- Peu bruyant & design élégant
- Produit de qualité allemand, estampillé TÜV et GSZ
- Valorise la qualité du service
- Garantie de satisfaction auprès de la clientèle
- Tissu de la housse non propagateur de flamme et facile à nettoyer

De
Tellerwärmer:

- Die Heizdauer bis zur Erreichung einer angenehmen Geschirrtemperatur von 40 bis 50° C beträgt je nach Außentemperatur 25 bis 40 Minuten.
- Es können bis zu 29 Teller mit einem Durchmesser von 29 cm warm gehalten werden, wobei der Stromverbrauch gering ist.
- Die integrierte Sensortechnologie ermöglicht eine langfristige Temperaturregelung.
- Geräuscharm und elegant im Design
- Deutsches Qualitätsprodukt, TÜV- und GSZ-geprüft
- Mehrwert im Service
- Kundenzufriedenheit garantiert
- Haube schwer entflammbar und leicht zu reinigen

Es
El calienta platos:

- El tiempo necesario para calentar el plato es – dependiendo de la temperatura exterior– de 25 a 40 minutos para lograr una adecuada temperatura de los artículos, de 40 a 50°C.
- Se pueden guardar hasta 29 platos de 29 cm, como máximo, manteniendo la temperatura con un bajo consumo de energía eléctrica.
- Control de temperatura de larga duración integrada gracias a la tecnología de sus sensores.
- Poco ruido y elegante diseño
- Producto alemán de alta calidad, con certificación Tüv y GSZ
- Valoriza la calidad del servicio
- Garantía de satisfacción de los clientes
- Tejido de la funda ignífuga de fácil limpieza



Plate warmer
Tellerwärmer
Chauffe-assiette
Calienta plato
1 1
100-TW30



PLATE WARMER

En

Plate warmer

Perfect for catering, especially when setting up a service in multiple locations. The plate warmer's versatility and portability - in a specially designed bag - guarantees optimum and easy use in service areas while providing full customer satisfaction. This means the plate warmer is easy and flexible to use, with low-energy consumption and fits all types of plates and cups.

Fr

Le chauffe-assiettes

Idéal dans la restauration, surtout lors de la mise en place d'une prestation multi-site. Grâce à son emploi flexible, tout comme son transport facile dans son sac spécialement conçu, le chauffe-assiettes garantit une utilisation optimale et facile dans les espaces de services tout en offrant pleine satisfaction à la clientèle. Le chauffe-assiettes permet une utilisation aisée et flexible ainsi qu'une faible consommation d'énergie et s'adapte à tous types d'assiettes et de tasses.

De

Tellerwärmer

Ideal in der Gastronomie, insbesondere bei Einsatz an mehreren Orten. Dank der flexiblen Verwendungsmöglichkeiten sowie des problemlosen Transports in der Spezialtasche sind eine optimale und einfache Verwendung des Tellerwärmers im Servicebereich ebenso wie höchste Kundenzufriedenheit gewährleistet. Der Tellerwärmer ist einfach und flexibel in der Verwendung, zeichnet sich durch geringen Energieverbrauch aus und ist für alle Arten von Tellern und Tassen geeignet.

Es

Calienta platos

Ideal en el ámbito de la restauración, en particular para servicios en multitud de emplazamientos. Gracias a su uso flexible y a su fácil transporte en una bolsa especialmente diseñada para este producto, el calienta platos garantiza una utilización óptima y fácil en los espacios de servicios, al tiempo que satisface plenamente a los clientes. El calienta platos permite un uso fácil y flexible, además tiene un bajo consumo de energía y se adapta a todo tipo de platos y tazas.



Thermal cover
Cloche thermique
Wärmeglocke
Campana térmica

TDHL01
 

External dimensions / Außenmaße/
dimensions extérieures / dimensiones exteriores:
ø 32,5 cm - 3 15/16"
h = 10 cm - 12 13/16"
Interior dimensions / Innenmaße /
dimensions intérieures / dimensiones interiores:
ø 29,5 cm - 2 6/16"
h = 6 cm - 11 10/16"

To be used with plates / Verwendbar mit den Tellern / S'utilise avec les assiettes / Se utiliza con los platos

BUBC26



CLFP27



NNPR27





THERMAL COVER

En Thermal cover

The RAK Porcelain thermal cover system guarantees outstanding performance maintaining optimum food temperatures. Dishes can be kept under excellent conditions for 30 minutes which is ideal for room service. Consisting of a base and cover, the set is made from a material 100% guaranteed for food contact. It is a double walled insulated construction. The two parts are dishwasher safe and are perfectly stackable to simplify both service and storage. The surface is very shock and scratch resistant.

Fr Cloche thermique

Le système de cloche thermique de RAK Porcelaine garantit d'excellentes performances de maintien en température. Les plats peuvent ainsi être conservés dans d'excellentes conditions durant 30 minutes, ce qui optimise l'utilisation notamment en service en chambre. Composé d'une sous-assiette et d'une cloche, l'ensemble est conçu dans un matériau 100% garanti contact alimentaire et formé d'une double paroi emprisonnant un matériau isolant. Les 2 parties peuvent s'entretenir au lave-vaisselle et sont parfaitement empilables afin de faciliter le service et le rangement. La surface est très résistante aux rayures et aux chocs.

De Wärmeglocke

Das Wärmeglockensystem von RAK Porzellan garantiert eine herausragende Warmhalteleistung. Die Gerichte werden so 30 Minuten lang unter hervorragenden Bedingungen warm gehalten, was insbesondere im Zimmerservice von Nutzen ist. Der Artikel aus Unterteller und Glocke besteht aus 100 % lebensmittelechtem, doppelwandigem Material mit isolierender Zwischenschicht. Beide Teile sind spülmaschinenfest und perfekt stapelbar. Die Oberfläche ist kratz- und stoßfest.

Es Campana térmica

El sistema de campana térmica de RAK Porcelaine garantiza un excelente rendimiento en el mantenimiento de la temperatura. Los platos pueden así conservarse en excelentes condiciones durante 30 minutos, lo que optimiza su utilización, en particular para el servicio de habitaciones. Compuesta por un bajoplató y una campana, el conjunto está concebido en un material garantizado en un 100 % para el contacto con los alimentos y formado por una doble pared que contiene material aislante. Las dos partes pueden lavarse en el lavavajillas y son perfectamente apilables para facilitar el servicio y guardarlo sin problemas. La superficie es muy resistente a las rayaduras y los choques.



RAK industrial site

QUALITY

En Our know-how meets outstanding longevity

Our intensive porcelain vitrification process strengthens the items, reduces the risk of chipping and withstands chemical degradation occurring in dishwashers to attain optimum strength. Being certain of the high longevity of our products means you, as a professional, can perfectly control your operating costs.

RAK Porcelain: the certified quality

RAK Porcelain strives for excellence. Each collection that we design follows strict specifications meeting European ISO 9001/2000 standards, approved by tests from Bureau Veritas, SFC in France and CERAM Laboratory in the United Kingdom.

Fr Notre savoir-faire au service d'une longévité hors pair

Notre procédé de vitrification intense de la porcelaine permet de renforcer les pièces, limiter les risques d'ébréchantures et résister aux agressions chimiques lors des passages au lave-vaisselle pour une résistance optimale. L'assurance de la grande longévité de nos produits vous permet, en tant que professionnels, une parfaite maîtrise des coûts d'exploitation.

RAK Porcelain : la qualité certifiée

RAK Porcelain aspire à l'excellence. Chaque collection développée suit un cahier des charges strict répondant aux normes européennes certifiées ISO 9001/2000, approuvées par les tests du bureau VERITAS, de SFC en France et du laboratoire CERAM au Royaume-Uni.

De Unser Know-how für unerreichte Langlebigkeit

Unser Verfahren zur Intensivversiegelung des Porzellans ermöglicht eine Verstärkung der Teile, senkt das Bruchrisiko und mindert die Gefahr einer chemischen Beschädigung während des Spülvorgangs. Das Porzellan bietet damit eine optimale Widerstandsfähigkeit. Weil Sie unsere Produkte viele Jahre lang einsetzen können, behalten Sie auch die Nutzungskosten genau im Blick.

RAK Porzellan: Zertifizierte Qualität

RAK Porzellan ist stets bestrebt, höchste Standards zu erreichen. Alle Kollektionen erfüllen eine Anforderungsspezifikation, die genau den nach ISO 9001/2000 zertifizierten Normen entspricht. Die Einhaltung der Spezifikationen wird von VERITAS sowie in Frankreich von SFC und in Großbritannien vom Labor CERAM geprüft.

Es Nuestro saber-hacer al servicio de una longevidad sin igual

Nuestro procedimiento de vitrificación intensa de la porcelana permite reforzar las piezas, reducir los riesgos de desportilladura y soportar las agresiones químicas del lavavajillas con una resistencia óptima. La garantía de longevidad de nuestros productos permite a los profesionales controlar los costes de explotación.

RAK Porcelain: calidad certificada

RAK Porcelana aspira a la excelencia. Todas las colecciones han sido desarrolladas siguiendo un estricto pliego de condiciones que responde a las normas europeas, cuentan con certificación ISO 9001:2000 y han sido acreditadas por la entidad Bureau VERITAS, SFC en Francia y por el laboratorio CERAM en el Reino Unido.



En



Oven + 300 °C

The RAK oven safe porcelain gradually increases in temperature to ensure gentle cooking of food meaning your dishes will keep their flavour longer.



Microwave

RAK porcelain ensures cooking or quick reheating without altering the taste or flavour of your dishes.



Holding of temperature

Once put on the table the dishes keep their heat ensuring the content remains at the right temperature giving you the time to enjoy it.



Dishwasher

The RAK porcelain's smooth enamel is quick and easy to clean. Thanks to the quality, your tableware will stay as new for a long time.



Mechanical shock

The exceptional hardness of the RAK porcelain ensures it is highly chip and shock resistant. It is therefore very easy to stack.



Thermal shock

From the freezer to the microwave, RAK porcelain withstands differences in temperature thanks to the exceptional hardness of its material making it highly thermal shock resistant.



100% Hygiene

RAK cooking porcelain is a 100% natural, guaranteed lead-free product. It is non-porous and does not absorb grease, odours or bacteria ensuring you optimum hygiene.

De

Ofen + 300 °C

RAK Porzellan erwärmt sich im Ofen progressiv, sodass Lebensmittel schonend gegart werden. Ihre Speisen wahren ihren Geschmack auf diese Weise länger.

Mikrowelle

RAK Porzellan garantiert Ihnen ein Garen oder schnelles Aufwärmen ohne Geschmacks- und Aromaveränderung Ihrer Speisen.

Warmhalten

Nach dem Servieren bleiben die Teller warm und halten den Inhalt auf einer angemessenen Temperatur, um Speisen ohne Zeitdruck zu genießen.

Geschirrspüler

Die glatte Oberfläche von RAK Porzellan ermöglicht eine schnelle, einfache Reinigung. Dank ihrer hohen Qualität sehen die Produkte auch nach längerem Gebrauch noch wie neu aus.

Mechanische Stöße

Die außergewöhnliche Härte von RAK Porzellan verstärkt die Kantenfestigkeit und Widerstandskraft gegenüber mechanischen Stößen. Auf diese Weise wird das Stapeln von Teilen erleichtert.

Wärmeschocks

RAK Porzellan widersteht Temperaturunterschieden zwischen Tiefkühlfach und Mikrowelle dank der außergewöhnlichen Härte seines Werkstoffs, die ihm eine hohe Festigkeit gegenüber Temperaturschocks verleiht.

100% Hygiene

RAK Küchenporzellan ist ein 100% natürliches Produkt, garantiert bleifrei. Es ist unporös und nimmt daher weder Fett noch Gerüche oder Bakterien auf; es sorgt somit für perfekte Hygiene.

Fr

Four + 300 °C

La porcelaine RAK mise au four monte progressivement en température pour une cuisson en douceur des aliments. Ainsi, vos préparations conservent leurs saveurs plus longtemps.

Micro-ondes

La porcelaine RAK vous assure une cuisson ou un réchauffage rapide sans altération des goûts ou des saveurs de vos préparations.

Maintien en température

Une fois sur la table, les plats restent chauds pour maintenir leur contenu à bonne température, le temps de la dégustation.

Lave-vaisselle

L'émail lisse de la porcelaine RAK permet un nettoyage facile et rapide. Grâce à leur grande qualité, vos pièces conserveront longtemps leur aspect neuf.

Choc mécanique

La dureté exceptionnelle de la porcelaine RAK lui confère une grande résistance à l'ébréchure et au choc mécanique. L'empilage des différentes pièces est ainsi facilité.

Choc thermique

Du congélateur au micro-ondes, la porcelaine RAK résiste aux écarts de température grâce à la dureté exceptionnelle de son matériau qui lui confère une grande résistance au choc thermique.

100 % Hygiène

La porcelaine culinaire RAK est un produit 100 % naturel, garantie sans plomb. Non poreuse, elle n'absorbe ni graisses, ni odeurs, ni bactéries et vous assure une hygiène parfaite.

Es

Horno +300°C

La porcelana RAK utilizada en el horno aumenta progresivamente su temperatura, para obtener una cocción lenta de los alimentos. Así, sus preparaciones conservarán el sabor durante más tiempo.

Microondas

La porcelana RAK le asegura una cocción o un recalentamiento rápido, sin alterar los sabores ni aromas de sus preparaciones.

Mantenimiento de la temperatura

Una vez en la mesa, las fuentes permanecen calientes para mantener los alimentos a la temperatura adecuada y disponer del tiempo que lleve su degustación.

Lavavajillas

El esmalte liso de la porcelana RAK permite una limpieza fácil y rápida. Gracias a su alta calidad, sus piezas conservarán más tiempo su aspecto nuevo.

Choque mecánico

La dureza excepcional de la porcelana RAK le confiere una gran resistencia a las desportilladuras y a los choques físicos. Así, el apilado de las distintas piezas queda facilitado.

Choque térmico

Del congelador al microondas, la porcelana RAK resiste a los cambios de temperatura gracias a la excepcional dureza de su material, que le confiere una gran resistencia a los choques térmicos.

100% Higiene

La porcelana para vajilla RAK es un producto 100% natural, garantizada sin plomo. Al no ser porosa, no absorbe la grasa, ni los olores, ni las bacterias y le garantiza una higiene perfecta.

PLATES SPECIFICATIONS

Reference Référence Referenz Referencia	Item Article Artikel Artículo	Profile view Vue de profil Profilschnitt Vista de perfil	Thickness of the rim Épaisseur de l'aile Randstärke Espesor de la ala	Profile type Type de profil Profiltyp Tipo de perfil	Lateral shock resistance Résistance aux chocs latéraux Bruchwiderstand Resistencia de choque lateral
FDFP27	Fine Dine 27 cm - 10 10/16"		3,6 mm 2/16"	Sharp Saillant Schlank Saliente	★★
NOFP28	Nordic 28 cm - 11"		3,0 mm 2/16"	Sharp Saillant Schlank Saliente	★★
GDSP26	White Gold King*** 26 cm - 10 4/16"		5,0 mm 3/16"	Rolled Rond Rund Redondo	★★★★
LRFP27	Lyra 27 cm - 10 10/16"		5,0 mm 3/16"	Sharp Saillant Schlank Saliente	★★
NBFP27	Nabur 27 cm - 10 10/16"		4,0 mm 3/16"	Rolled Rond Rund Redondo	★★
SPSP27	AllSpice 27 cm - 10 10/16"		4,0 mm 3/16"	Sharp Saillant Schlank Saliente	★★
MZSP26	Mazza 26 cm - 10 4/16"		4,5 mm 3/16"	Rolled Rond Rund Redondo	★★
CLFP27	Classic Gourmet* 27 cm - 10 10/16"		5,0 mm 3/16"	Strength Rond renforcé Rund verstärkt Redondeado reforzado	★★★★★
SKRFP28	Ska Round 28 cm - 11"		4,5 mm 3/16"	Rolled Rond Rund Redondo	★★★★
PXFP27	Pixel 27 cm - 10 10/16"		5,0 mm 3/16"	Strength Rond renforcé Rund verstärkt Redondeado reforzado	★★★★★
SKSFP27	Ska Square 27 cm - 10 10/16"		5,1 mm 3/16"	Rolled Rond Rund Redondo	★★★★
BAFP27	Banquet** 27 cm - 10 10/16"		5,1 mm 3/16"	Strength Rond renforcé Rund verstärkt Redondeado reforzado	★★★★★

* Also applies on Line-Z and Playa and decorated items 1973 and Tweeg / Auch auf Line-Z und Playa anwendbar und Dekorationselemente 1973 und Tweeg / Applicable également sur Line-Z et Playa et les éléments décoratifs 1973 et Tweeg / Aplicable también sobre Line Z y Playa y artículos decorados 1973 y Tweeg

** Also applies on Metropolis, Leon, Rondo and decorated items Bahamas, Yasmineen and Castello / Auch auf Metropolis, Leon, Rondo anwendbar und Dekorationselemente Bahamas, Yasmineen und Castello / Applicable également sur Metropolis, Leon, Rondo et les éléments décoratifs Bahamas, Yasmineen et Castello / Aplicable también sobre Metropolis, Leon, Rondo y artículos decorados Bahamas, Yasmineen y Castello

Weight Poids Gewicht Peso	Recommendations of use Recommandations d'usage Gebrauchsempfehlungen Recomendación de uso	Design perception Perception design Design-Empfindung Percepción diseño		
640 g 1 7/16 lbm	Intensive Soutenu Sehr häufig Constante	Fine dining Restauration haut de gamme Top-Gastronomie Restauración de gama alta	Premium Premium Premium Premium	★★★★★
810 g 1 13/16 lbm	Intensive Soutenu Sehr häufig Constante	Fine dining Restauration haut de gamme Top-Gastronomie Restauración de gama alta	Premium Premium Premium	★★★★★
880 g 1 15/16 lbm	Intensive Soutenu Sehr häufig Constante	Fine dining Restauration haut de gamme Top-Gastronomie Restauración de gama alta	Premium Premium Premium	★★★★★
710 g 1 9/16 lbm	Intensive Soutenu Sehr häufig Constante	Fine dining Restauration haut de gamme Top-Gastronomie Restauración de gama alta	Premium Premium Premium	★★★★★
676 g 1 8/16 lbm	Intensive Soutenu Sehr häufig Constante	Fine dining Restauration haut de gamme Top-Gastronomie Restauración de gama alta	Premium Premium Premium	★★★★★
900 g 2 lbm	Intensive Soutenu Sehr häufig Constante	Fast moving restaurants Restauration traditionnelle Großgastronomie Restauración tradicional	Elegant Élégant Elegant Elegante	★★★
860 g 1 4/16 lbm	Semi-intensive Semi-intensif Häufig Semi-intensivo	Fast moving restaurants Restauration traditionnelle Großgastronomie Restauración tradicional	Elegant Élégant Elegant Elegante	★★★
710 g 1 9/16 lbm	Heavy-duty Intensif Intensiv Intensivo	Bistro-Brasserie - banqueting - catering Bistro-Brasserie - banqueting - catering Großgaststätten - banqueting - catering Bar - cervecería - banquets - catering	Elegant Élégant Elegant Elegante	★★★
930 g 2 1/16 lbm	Heavy-duty Intensif Intensiv Intensivo	Bistro-Brasserie - banqueting - catering Bistro-Brasserie - banqueting - catering Großgaststätten - banqueting - catering Bar - cervecería - banquets - catering	Standard Courant Standard Estándar	★★
730 g 1 10/16 lbm	Heavy-duty Intensif Intensiv Intensivo	Bistro-Brasserie - banqueting - catering Bistro-Brasserie - banqueting - catering Großgaststätten - banqueting - catering Bar - cervecería - banquets - catering	Standard Courant Standard Estándar	★★
910 g 2 lbm	Heavy-duty Intensif Intensiv Intensivo	Bistro-Brasserie - banqueting - catering Bistro-Brasserie - banqueting - catering Großgaststätten - banqueting - catering Bar - cervecería - banquets - catering	Strong, standard Robuste, courant Robust, standard Robusto, estándar	★★
750 g 1 10/16 lbm	Heavy-duty Intensif Intensiv Intensivo	Bistro-brasserie - banqueting - catering Bistro-brasserie - banqueting - catering Großgaststätten - banqueting - catering Bar - cervecería - banquets - catering	Strong, standard Robuste, courant Robust, standard Robusto, estándar	★★

*** Also applies on Golden and Zephyr / Auch auf Golden und Zephyr anwendbar / Applicable également sur Golden et Zephyr / Aplicable también sobre Golden y Zephyr

SHAPES

Round with rim / Rund mit Rand / Ronde à aile / Redondo con ala



Square / Quadratisch / Carrée / Cuadrado



Irregular Design / Asymmetrisch / Déstructurée / Deestructurado



Round rimless / Rund ohne Rand / Ronde coupe / Redondo sin borde

Nordic Nano AllSpice
Cilantro 

Rectangular / Rechteckig / Rectangulaire / Rectangular

Line-Z Ska
Steak Classic Gourmet Mazza
Rectangular Playa AllSpice
Wasabi AllSpice
Pepper Minimax
Sandwich platter 

Oval / Oval / Ovale / Oval

Banquet
Steak Nano
oval rimless Banquet
oval with rim Pixel
oval Fine Dine
oval 

 Heavy-duty
Für intensiven Gebrauch
Usage intensif
Usso intensivo

 Intensive use
Für häufigen Gebrauch
Usage soutenu
Usso costante



DISHES FOR ALL TYPES OF COOKING

En Cookware

Our easy-to-use “universal cooking” dishes let you cook, present and serve your culinary creations straight from oven to the table, for dining room service or a buffet presentation. Designed according to rigorous quality standards, our large dishes or individual portions simplify the daily work of catering professionals and offer a variety of products to suit every need.

Fr Articles culinaires

Faciles d’emploi, nos plats «toutes cuissons» permettent de cuire, de présenter et de servir vos créations culinaires directement du four à la table, pour un service en salle ou pour une présentation sur buffet. Conçus à partir de critères de qualité rigoureux, nos plats de grande taille ou nos portions individuelles simplifient le travail quotidien des professionnels de la restauration et offrent une diversité adaptée à chaque besoin.

De Kulinarische Artikel

Unsere praktischen Formen für alle Herdarten können zur Zubereitung, zum Anrichten und zum Servieren der kulinarischen Kreationen verwendet werden. So gelangen die Speisen gleich aus dem Ofen auf den Tisch oder aufs Buffet. Die nach rigorosen Qualitätskriterien entwickelten Groß- und Portionsformen erleichtern die tägliche Arbeit in der Gastronomie und bieten durch ihre große Vielfalt in jeder Situation die richtige Lösung.

Es Artículos culinarios

De uso fácil, nuestras fuentes “para todo tipo de cocción” permiten cocinar, presentar y servir las creaciones culinarias directamente del horno a la mesa, para un servicio en sala o una presentación de tipo buffet. Concebidas con rigurosos criterios de calidad, nuestras fuentes de gran tamaño o nuestras porciones individuales simplifican el trabajo diario de los profesionales de la restauración y ofrecen una diversidad adaptada a cada necesidad.

DISHES WITH GRIP HANDLES

PLATS À OREILLES
SCHALEN MIT GRIFFEN
PLATO CON ASAS



Eared oval dish
Plat à gratin ovale
Platte oval
Plato oval
OPOD30 30 x 16 x 5,2 cm - 78 cl
11 13/16 x 6 5/16 x 2 1/16" -
26 6/16 oz
6



Eared oval dish
Plat à gratin ovale
Platte oval
Plato oval
OPOD25 25 x 14 x 4,3 cm - 42 cl
9 13/16 x 5 8/16 x 1 11/16" -
14 3/16 oz
24



Eared oval dish
Plat à gratin ovale
Platte oval
Plato oval
OPOD24 24 x 13 x 4 cm - 32,5 cl
9 7/16 x 5 2/16 x 1 9/16" - 11 oz
12



Eared oval dish
Plat à gratin ovale
Platte oval
Plato oval
OPOD20 20 x 11 x 3,5 cm - 20 cl
7 14/16 x 4 5/16 x 1 6/16"
12



Eared round dish
Plat à gratin rond
Platte rund
Plato redondo
OPRD16 16 cm - 45 cl
6 5/16 - 15 3/16"
12



Rectangular dish with grip
Plat rectangulaire à poignées
Platte rechteckig mit Griffen
Plato rectangular con asas
OPRT16 16 cm / 6 5/16"
6

LARGE DISHES

PLATS DE GRANDE TAILLE

GROSSE SCHALEN

FUENTES GRANDES

**Oval dish**

Plat oval
Platte oval
Fuente oval

BUOV40 40 x 23 x 4 cm - 154 cl
15 15/16 x 9 1/16 x 1 9/16" -
52 1/16 oz

**Oval dish**

Plat oval
Platte oval
Fuente oval

BUOV36 36 x 22 x 5 cm - 136 cl
14 3/16 x 8 7/16 x 1 15/16" -
46 oz

**Oval dish**

Plat oval
Platte oval
Fuente oval

BUOV29 29 x 14 x 5,7 cm - 100 cl
11 10/16 x 5 8/16 x 2 4/16" -
33 13/16 oz

**Oval dish**

Plat oval
Platte oval
Fuente oval

BUOV24 24 x 14,3 x 4,2 cm - 54 cl
9 7/16 x 5 10/16 x 1 10/16" -
18 4/16 oz

**Oval dish**

Plat ovale
Platte oval
Fuente oval

BUOD37 37 x 25,5 x 5 cm
14 9/16 x 10 1/16 x 1 15/16"

**Oval dish**

Plat ovale
Platte oval
Fuente oval

BUOD30 30 x 20 x 5 cm
11 13/16 x 7 14/16 x 1 15/16"

**Oval dish**

Plat oval
Platte oval
Fuente oval

BUOD28 28 x 19 x 5 cm
11 x 7 8/16 x 1 15/16"

**Oval dish**

Plat oval
Platte oval
Fuente oval

BUOD25 25 x 18 x 5 cm
9 13/16 x 7 1/16 x 1 15/16"

**Oval platter**

Plat ovale
Platte oval
Fuente oval

BUOP56 56 x 21 cm - 220 cl
22 1/16 x 8 4/16" - 74 6/16 oz

**Rectangular pan**

Plat rectangulaire
Platte rechteckig
Fuente rectangular

BURP44 44 x 36 x 6 cm - 500 cl
17 5/16 x 14 3/16 x 2 6/16" -
169 1/16 oz

**Rectangular pan**

Plat rectangulaire
Platte rechteckig
Fuente rectangular

BURP37 37 x 30 x 6 cm - 347 cl
14 9/16 x 11 10/16 x 2 6/16" -
117 5/16 oz

**Rectangular pan**

Plat rectangulaire
Platte rechteckig
Fuente rectangular

BURP30 30 x 23,8 x 6,4 cm - 212 cl
11 13/16 x 9 6/16 x 2 8/16" -
71 11/16 oz



DISHES/RAMEKINS

COUPELLES/RAMEQUINS
SCHÄLCHEN/AUFLAUFFORMEN
COPELA/CUENCOS



Square dish
Ravier carré
Schale quadratisch
Rabanera cuadrada
SKSTD11 11 x 11 cm / 4 5/16 x 4 5/16"
 12



Oval pie dish stackable
Plat à gratin oval empilable
Kuchenteller oval stapelbar
Fuente a tarta apilable
OPOS20 20 x 12 cm - 42 cl
7 14/16 x 4 12/16" - 14 3/16 oz
 6



Pie dish
Plat à gratin
Schale rechteckig
Plato postre
OPPD15 15 x 11 - 28 cl
5 14/16 x 4 5/16 - 9 7/16 oz
 6



Rectangular dish
Ravier rectangulaire
Schale rechteckig
Plato postre
SKRTD15 15 x 10 x 3,5 cm - 22 cl
5 14/16 x 3 15/16 x 1 6/16" -
7 7/16 oz
 12



Ramekin Chives
Ramequin Chives
Auflaufform Chives
Cuenco Chives
SPCB32 14 cm - 32 cl / 5 8/16" - 10 13/16 oz
 6



Ramekin Chives
Ramequin Chives
Auflaufform Chives
Cuenco Chives
SPCB20 11 cm - 20 cl / 4 5/16" - 6 12/16 oz
 6



Ramekin Chives
Ramequin Chives
Auflaufform Chives
Cuenco Chives
SPCB11 8 cm - 11 cl / 3 2/16" - 3 12/16 oz
 6



Ramekin
Ramequin
Auflaufform
Cuenco
BABR02 8 cm - 10 cl / 3 2/16" - 3 6/16 oz
 12



Ramekin stackable
Ramequin empilable
Auflaufform stapelbar
Cuenco apilable
BABR03 7 cm - 6 cl / 2 12/16" - 2 oz
 12



Ramekin
Ramequin
Auflaufform
Cuenco
BABR01 7 cm - 6 cl / 2 12/16"
 12



Ramekin with grooves
Ramequin plissé
Auflaufform gerillt
Cuenco estriado
ACRG10 10 cm - 7 cm - 33 cl
3 15/16" - 2 12/16" - 11 3/16 oz
 12



Ramekin with grooves
Ramequin plissé
Auflaufform gerillt
Cuenco estriado
ACRG09 9 cm - 5 cm - 19 cl
3 9/16" - 1 15/16" - 6 7/16"
 12



Ramekin
Ramequin
Auflaufform
Cuenco
BABW14 14 cm - 6 cm - 63 cl
5 8/16" - 2 6/16" - 21 5/16 oz
 12



Ramekin
Ramequin
Auflaufform
Cuenco
BABW12 12 cm - 6 cm - 48 cl
4 12/16" - 2 6/16" - 16 4/16 oz
 12



Square bowl
Coupelle carrée
Schälchen quadratisch
Bol frutero cuadrado
OPFB10 10 x 10 x 4 cm - 18 cl
3 15/16 x 3 15/16 x 1 9/16" -
6 12/16 oz
 6

TUREEN ET CASSEROLES

TERRINES ET CASSELETTES
TERRINES UND PFÄNNCHEN
TARRINAS Y CACEROLA



Rectangular tureen & Lid
Terrine rectangulaire & couvercle
Terrine rechteckig & Deckel
Tarrina rectangular & tapa

OPTU23 23 x 18 x 13,7 cm - 160 cl
9 1/16 x 7 1/16 x 5 6/16" -
54 2/16 oz



Rectangular tureen & Lid
Terrine rectangulaire & couvercle
Terrine rechteckig & Deckel
Tarrina rectangular & tapa

OPTU20 19,5 x 15,4 x 11,6 cm - 104 cl
7 11/16 x 6 1/16 x 4 9/16" -
35 3/16 oz



Rectangular tureen & Lid
Terrine rectangulaire & couvercle
Terrine rechteckig & Deckel
Tarrina rectangular & tapa

OPTU16 16,4 x 13,5 x 10 cm - 60 cl
6 7/16 x 5 5/16 x 3 15/16" -
20 5/16 oz



Rectangular tureen & Lid
Terrine rectangulaire & couvercle
Terrine rechteckig & Deckel
Tarrina rectangular & tapa

OPTU15 15 x 11,8 x 9 cm - 39 cl
5 14/16 x 4 10/16 x 3 9/16" -
13 3/16 oz



Rectangular tureen & Lid
Terrine rectangulaire & couvercle
Terrine rechteckig & Deckel
Tarrina rectangular & tapa

OPTU13 13 x 10,2 x 7,7 - 30 cl
5 2/16 x 4 x 3 1/16" -
10 2/16 oz



Rectangular tureen & Lid
Terrine rectangulaire & couvercle
Terrine rechteckig & Deckel
Tarrina rectangular & tapa

OPTU12 11,7 x 9,2 x 7 cm - 20 cl
4 10/16 x 3 10/16 x 2 12/16" -
6 12/16 oz



Handi* bowl & lid
Bol handi & couvercle
Handi Schale & Deckel
Handi Bol & tapa

OPHB150 17 x 18,5 x 13 cm - 150 cl
6 11/16 x 7 5/16 x 5 2/16" -
50 12/16 oz



Handi* bowl & lid
Bol handi & couvercle
Handi Schale & Deckel
Handi Bol & tapa

OPHB89 19 x 19,5 x 10 cm - 90 cl
7 8/16 x 7 11/16" x 3 15/16"
- 30 7/16 oz



Handi* bowl & lid
Bol handi & couvercle
Handi Schale & Deckel
Handi Bol & tapa

OPHB85 14,8 x 16,5 x 11 cm - 85 cl
5 13/16 x 6 8/16 x 4 5/16" -
28 12/16 oz



Handi* bowl & lid
Bol handi & couvercle
Handi Schale & Deckel
Handi Bol & tapa

OPHB50 14,5 x 15,5 x 9 cm - 50 cl
5 11/16 x 6 2/16 x 3 9/16" -
16 15/16 oz



**Handi is an indish bowl*

**Handi est un bol indien*

**Handi ist eine indische Schale*

**Handi es un bol indio*

Pieces per box
Pièces par boîte
Stück pro Karton
Piezas por caja

Stored in Europe
Entreposé en Europe
In Europa gelagert
Almacendo en Europa



MAKE SURE
IT'S RAK



RAK PORCELAIN UNITED ARAB EMIRATES
P.O. BOX - 30113 - RAS AL KHAIMAH
UNITED ARAB EMIRATES

T (+971) 7 243 4683
F (+971) 7 243 4220

RAKPORCELAIN@RAKCERAM.COM
WWW.RAKPORCELAIN.COM

RAK PORCELAIN EUROPE S.A.
20, RUE DE L'INDUSTRIE
L-8399 WINDHOF · LUXEMBOURG

T (+352) 26 36 06 65
F (+352) 26 36 04 65

INFO@RAKPORCELAINEUROPE.COM
WWW.RAKPORCELAIN.EU